

E1 Series Servo Drive Thunder Software Operation Manual

The screenshot displays the Thunder software interface for an E1 Series Servo Drive. The main window is titled "Homing Operation" and contains the following configuration parameters:

- Fast speed (P1701): 20 rpm
- Slow speed (P1702): 6 rpm
- Timeout (P1703): 50 s
- Home offset (P1704): 0 ctrl unit
- Home method (P1700): Method8: Homing on home switch and index pulse - positive initial move

Below the parameters is a diagram illustrating the homing process. The diagram shows a horizontal axis with a motor and a home switch. The motor moves from the right towards the left. The home switch is located on the left. The diagram shows the motor moving until it reaches the home switch, which then triggers the homing process. The diagram also shows the Index signal and the Positive Limit signal.

On the left side of the interface, there is a tree view showing the drive configuration:

- E1 X
 - Ver. ED1S, 2.4.6
 - Typ. Pulse
 - Pwr. Frame C, 1kW
 - Mod.
 - 1. Position mode v
 - 2. N/A
 - Act. Inner position m
 - Mot.
 - Typ. AC servo
 - Mod. FNMS75209
 - Enc.
 - Int.
 - Typ. Serial
 - Res. 23 bits, 8.
 - Ext.
 - Typ. Serial
 - Res. 23 bits, 8.
 - ESC
 - Typ. N/A

At the bottom left, there is a status section with the following indicators:

- No Error
- No Warning
- Servo ready (grey square)
- Drive ready (green square)
- Input voltage is above 220V. (checked)
- No alarm occurs. (checked)
- Motor parameters are set. (checked)
- FSTP signal is off. (checked)
- STO (grey square)
- Servo on input (grey square)
- Gantry mode (grey square)

Revision History

The version of the manual is also indicated on the bottom of the front cover.

MD12UE01-2012_V2.2

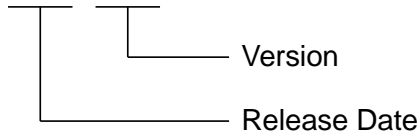

Release Date	Version	Applicable Product	Revision Contents
Dec. 31 th , 2020	2.2	E1 series servo drive	<ol style="list-style-type: none"> 1. Update section 1.5 Function list. 2. Update section 2.2 Download Thunder. 3. Update section 3.2.2 Connect via USB. 4. Update section 3.4 Update firmware. 5. Update section 4.3.1 Servo Drive Configuration – Brief introduction. 6. Update section 4.3.2 Power Setup. 7. Update section 4.3.4.1 Edit encoder parameters. 8. Update section 4.3.5 Control Mode Setup. 9. Update section 4.3.6.2 Position mode. 10. Update section 4.3.6.3 Electronic gear ratio setting. 11. Update section 4.3.9 Send to drive. 12. Update section 4.4.3.2 Save servo drive parameters file (*.prm). 13. Update section 4.4.3.3 Load servo drive parameters file (*.prm). 14. Update section 4.6.2.1 Parameters setup for direction test. 15. Update section 4.6.3.2 STABS test/tune. 16. Update section 5.2 Test Run. 17. Update section 5.3 Homing Operation. 18. Update section 6.2 Auto tune. 19. Update section 6.4 Spectrum analyzer. 20. Update section 7.3.1 Lissajous.

Release Date	Version	Applicable Product	Revision Contents
			<ul style="list-style-type: none"> 21. Update section 7.5.7 Monitoring items. 22. Update section 9.2.1 Multi-motion setting – Brief introduction. 23. Update section 9.2.3 Set multi-motion parameters. 24. Add section 9.2.9 Instructions for customized motion. 25. Update section 9.6.1 Error map setup – Brief introduction. 26. Update section 9.6.2.1 Error map information setting. 27. Update section 9.7.1 Gantry control system – Brief introduction. 28. Update section 11.1.3 Examples for servo drive configuration – Linear motor.
Sep. 4 th , 2020	2.1	E1 series servo drive	Rewrite and reorganize this user manual based on Traditional Chinese user manual E1 系列驅動器 Thunder 軟體操作手冊 (version 2.1).
Apr. 24 th , 2020	1.2	E1 series servo drive	Add section “Multi-motion setting”.
Dec. 31 th , 2019	1.1	E1 series servo drive	<ul style="list-style-type: none"> 1. Update screenshots. 2. Add section “STABS”.
Mar. 28 th , 2019	1.0	E1 series servo drive	<ul style="list-style-type: none"> 1. Update screenshots. 2. Add section “Performance monitor”, “Calculate dynamic brake resistor”, and “Access”. 3. Add description of steps in “PDL”. 4. Update operating methods in “Error map setup”.
Jan. 18 th , 2019	0.1	E1 series servo drive	First edition.

Preface

This manual provides users the information and methods of operating each function in Thunder software, a human-machine interface for E1 series servo drive. The contents in this manual are arranged in accordance with function options. Carefully read through this manual to correctly operate Thunder software.

- Reverse compiling or assembly of this software is strictly prohibited.
- Use of this software in whole or in part by a third party through transfer, exchange, resale, and so forth, is strictly prohibited without the prior agreement of HIWIN MIKROSYSTEM Corporation.
- The copyrights and all other rights to the software belong to HIWIN MIKROSYSTEM Corporation.

Safety Precautions

To prevent personal injury and equipment damage in advance, the following signal words are used to indicate safety precautions in this manual. The signal words are used to classify the hazards and damage or injury that may occur if a product is used incorrectly. Information marked as shown below is important for safety. Always read this information and heed the precautions that are provided.

DANGER

- ◆ Obviously at dangerous state; if not heeded, it may cause **death or serious injury** and may damage equipment and property. Special safety protection and management must be carried out to avoid danger.

WARNING

- ◆ The condition of usage is at dangerous state; if not heeded, it may cause **medium level injury** and may damage equipment and property. Special safety protection and management must be carried out to avoid danger.

CAUTION

- ◆ The condition of usage is at dangerous state; if not heeded, it may cause **minor injury** and may damage equipment and property. Special safety protection and management must be carried out to avoid danger.

Technical Terms

Term	Meaning
Servo motor	A generic name for AC servo motor, direct drive motor (DM), torque motor (TM) and linear motor (LM).
Rotary motor	A generic name for AC servo motor, direct drive motor (DM) and torque motor (TM).
Linear motor	A generic name for linear motor (LM).
Servo drive	A generic name for standard and Fieldbus servo drive.
Standard servo drive	The model is ED1S. A generic name for servo drive with the control interface of voltage command and pulse.
Fieldbus servo drive	The model is ED1F. A generic name for servo drive with the control interface of Fieldbus type (such as EtherCAT and mega-ulink).
AC servo motor dedicated servo drive	A generic name for servo drive which only supports EM1 series AC servo motor.
Excellent smart cube (ESC)	An equipment which converts signals (encoder signal, signal of thermal sensor, Hall signal, etc.) from motor side into serial communication format for servo drive. In this manual, it is called ESC.
Enable	Supply power to motor.
Disable	Do not supply power to motor.
Servo ready	Power is supplied to motor.
Drive ready	Servo drive is ready; it can supply power to motor anytime.
Flash	Servo drive's memory.
Immediately effective parameter	Parameter will immediately be effective after it is modified.
Non-immediately effective parameter	Parameter will not be effective until it is sent to servo drive and servo drive is power cycled.





Differences in Terms for Rotary Motor and Linear Motor

There are differences in terms for rotary motor and linear motor. This manual primarily describes rotary motor. If linear motor is used, interpret the terms given in the following table.

Rotary motor	Linear motor
torque	force
moment of inertia	mass
rotation	movement
forward rotation and reverse rotation	forward movement and reverse movement
CW and CCW command pulse	forward and reverse command pulse
rotary encoder	linear encoder
absolute rotary encoder	absolute linear encoder
incremental rotary encoder	incremental linear encoder
unit: rpm	unit: mm/s
unit: N·m	unit: N

Visual Aids

The following aids are used to indicate certain types of information for easier reference.

 Important	Indicates precautions or restrictions that must be observed. Also indicates alarm displays and other precautions that will not result in machine damage.
 Term	Indicates definitions of difficult terms or terms that have not been previously explained in this manual.
 Example	Indicates operating or setting examples.
 Information	Indicates supplemental information to deepen understanding or useful information.

Chapter Overview

Chapter	Title	Contents
1	Thunder Overview	Introduce Thunder's system requirements, functions, main window and the list of all functions.
2	Install Thunder	Explain the way to download, install, repair and remove Thunder software from official website.
3	Start Thunder	Explain how to start Thunder, including servo drive's connection and communication settings, mastership switching and firmware updating.
4	Servo Drive Configuration	Introduce all the basic setting procedures of using servo drive.
5	Perform Test Run	When servo drive configuration is done, users can test motor's performance with test run function, and decide home position with homing function.
6	Tuning	Users can optimize the response of motor by adjusting servo gains.
7	Monitoring	Users can monitor servo drive's message, operation and status via Thunder.
8	Troubleshooting	When an alarm or a warning occurs, Thunder main window will respond in real-time. Besides, it records the past alarm messages, elaborates the possible causes, and provides manual troubleshooting methods in Error log.
9	Advanced Functions	Introduce the special functions supported by Thunder. Users can use them based on different situation.
10	Basic Settings of Thunder Interface	Introduce the basic settings of Thunder interface, such as language changing and unit conversion.
11	Appendix	Provide the supplementary information related to Thunder, such as examples for servo drive configuration.

Table of Contents

1.	Thunder Overview	1-1
1.1	Brief introduction	1-2
1.2	System requirements	1-3
1.3	Thunder functions	1-4
1.4	Main window	1-5
1.5	Function list.....	1-6
2.	Install Thunder	2-1
2.1	Brief introduction	2-2
2.2	Download Thunder	2-3
2.3	Install Thunder	2-7
2.4	Install USB driver	2-11
2.5	Remove Thunder	2-16
3.	Start Thunder	3-1
3.1	Brief introduction	3-2
3.2	Connection and communication settings.....	3-3
3.2.1	Brief introduction	3-3
3.2.2	Connect via USB.....	3-4
3.2.3	Connect via mega-ulink	3-6
3.2.3.1	Multi-axes connection.....	3-6
3.2.3.2	Switch to different axis.....	3-9
3.2.3.3	Modify axis name.....	3-10
3.2.4	Off-line mode.....	3-11
3.3	Mastership switching	3-14
3.3.1	From Controller to Thunder.....	3-15
3.3.2	From Thunder to Controller.....	3-16
3.4	Update firmware	3-17
4.	Servo Drive Configuration	4-1
4.1	Brief introduction	4-3
4.2	Pre-configuration function.....	4-4
4.3	Configuration Wizard	4-6
4.3.1	Brief introduction	4-6
4.3.2	Power Setup.....	4-7
4.3.3	Motor Setup.....	4-9
4.3.3.1	Edit motor parameters	4-10
4.3.3.2	Save / Load motor parameters file (*.mot)	4-12
4.3.4	Encoder Setup	4-14

4.3.4.1	Edit encoder parameters	4-15
4.3.4.2	Save / Load encoder parameters file (*.enc).....	4-20
4.3.5	Control Mode Setup	4-22
4.3.6	Command Input Setup	4-24
4.3.6.1	Velocity mode	4-24
4.3.6.2	Position mode	4-26
4.3.6.3	Electronic gear ratio setting	4-32
4.3.6.4	Torque mode.....	4-38
4.3.6.5	Internal velocity mode.....	4-39
4.3.6.6	Internal position mode	4-40
4.3.7	Emulated Encoder Output Setup	4-42
4.3.8	I/O configuration.....	4-44
4.3.9	Send to drive	4-45
4.4	Parameters Setup.....	4-47
4.4.1	Brief introduction	4-47
4.4.2	Edit parameters.....	4-48
4.4.2.1	Parameters comparison	4-49
4.4.2.2	Set Pt parameters.....	4-50
4.4.2.3	User-defined parameters.....	4-52
4.4.2.4	Send to drive.....	4-57
4.4.3	Create a servo drive parameters file.....	4-58
4.4.3.1	Brief introduction.....	4-58
4.4.3.2	Save servo drive parameters file (*.prm).....	4-58
4.4.3.3	Load servo drive parameters file (*.prm)	4-60
4.4.4	Send the parameters to servo drive.....	4-63
4.4.5	Reset drive	4-64
4.4.6	Set to factory default	4-66
4.4.6.1	Brief introduction.....	4-66
4.4.6.2	Set to factory default.....	4-67
4.4.6.3	Clear error map table.....	4-68
4.4.6.4	Disable multi-motion function	4-69
4.4.6.5	Clear PDL	4-70
4.5	I/O configuration	4-71
4.5.1	Brief introduction	4-71
4.5.2	Configuration of digital input signals	4-72
4.5.3	Configuration of digital output signals.....	4-75
4.5.4	Check configuration of I/O signals	4-78
4.6	Phase initialization setup	4-79
4.6.1	Brief introduction	4-79
4.6.2	Direction test	4-81
4.6.2.1	Parameters setup for direction test.....	4-81
4.6.2.2	Start direction test.....	4-84

4.6.3	Phase initialization function.....	4-88
4.6.3.1	SW method 1	4-89
4.6.3.2	STABS test/tune	4-90
4.6.3.3	Digital hall	4-91
4.6.4	Start phase initialization	4-93
5.	Perform Test Run	5-1
5.1	Brief introduction	5-2
5.2	Test Run.....	5-3
5.2.1	Brief introduction	5-3
5.2.2	Position mode	5-3
5.2.3	Velocity mode.....	5-8
5.3	Homing Operation.....	5-11
6.	Tuning	6-1
6.1	Brief introduction	6-2
6.2	Auto tune	6-4
6.3	Tuneless	6-9
6.4	Spectrum analyzer.....	6-12
7.	Monitoring	7-1
7.1	Brief introduction	7-2
7.2	Monitor servo drive's information.....	7-3
7.3	Monitor servo drive's signal status	7-5
7.3.1	Lissajous	7-9
7.3.1.1	Waveform display area	7-10
7.4	Performance monitor	7-15
7.5	Scope.....	7-17
7.5.1	Current monitoring item	7-20
7.5.2	Start scope with pre defined variables/scenarios	7-21
7.5.3	Fix range/Auto range setup.....	7-23
7.5.4	Grid light.....	7-24
7.5.5	Set number of scope channels	7-26
7.5.6	Start or pause waveform monitoring.....	7-27
7.5.7	Monitoring items.....	7-28
7.6	Real-time data collection	7-30
7.6.1	Interface introduction	7-31
7.6.1.1	Save record settings	7-32
7.6.1.2	Load record settings	7-33
7.6.1.3	Operation and settings for collection	7-34
7.6.1.4	Add new tab.....	7-42
7.6.1.5	Sampling settings	7-43

7.6.2	Plot view	7-46
7.6.2.1	Open	7-47
7.6.2.2	Save.....	7-48
7.6.2.3	Set show mode	7-49
7.6.2.4	Set maximum number of graph views	7-51
7.6.2.5	Zoom the area between cursors.....	7-54
7.6.2.6	Undo zoom	7-55
7.6.2.7	Redo zoom	7-56
7.6.2.8	Statistics table.....	7-57
8.	Troubleshooting.....	8-1
8.1	Brief introduction	8-2
8.2	Real-time monitoring.....	8-3
8.2.1	Brief introduction	8-3
8.2.2	Alarm monitoring	8-3
8.2.3	Warning monitoring	8-4
8.3	Error log	8-5
9.	Advanced Functions.....	9-1
9.1	Brief introduction	9-3
9.2	Multi-motion setting.....	9-3
9.2.1	Brief introduction	9-3
9.2.2	Preparation.....	9-5
9.2.3	Set multi-motion parameters	9-6
9.2.4	Send multi-motion parameters to servo drive and activate multi-motion function	9-11
9.2.5	Read multi-motion parameters from servo drive.....	9-12
9.2.6	Load multi-motion parameters file (*.mtk).....	9-13
9.2.7	Save multi-motion parameters file (*.mtk).....	9-14
9.2.8	Clear multi-motion parameters and disable multi-motion function.....	9-15
9.2.9	Instructions for customized motion	9-16
9.3	Absolute encoder initialization	9-19
9.3.1	Brief introduction	9-19
9.3.2	Interface introduction	9-20
9.3.2.1	Message field.....	9-21
9.4	Analog offset.....	9-22
9.4.1	Brief introduction	9-22
9.4.2	Interface introduction	9-22
9.5	PDL.....	9-24
9.5.1	Brief introduction	9-24
9.5.2	Open PDL	9-25
9.5.3	Compile and save PDL	9-26
9.6	Error map setup	9-28

9.6.1	Brief introduction	9-28
9.6.2	Error map setup	9-29
9.6.2.1	Error map information setting	9-30
9.6.2.2	Load error map	9-32
9.6.2.3	Save / Read error map	9-33
9.6.3	Activate error map.....	9-35
9.7	Gantry control system.....	9-36
9.7.1	Brief introduction	9-36
9.7.2	Preparation.....	9-37
9.7.3	Gantry setting.....	9-38
9.8	Dynamic brake resistor wizard	9-41
9.8.1	Brief introduction	9-41
9.8.2	Motor parameters setting	9-42
9.8.2.1	Motor parameters	9-44
9.8.2.2	HIWIN motor	9-45
9.8.2.3	Read parameters	9-46
9.8.2.4	Other brand motor	9-47
9.8.3	Application parameters setting.....	9-48
9.8.4	Calculation results.....	9-50
9.8.5	Save / Load	9-54
10.	Basic Settings of Thunder Interface	10-1
10.1	Brief introduction.....	10-2
10.2	Display unit switching	10-2
10.2.1	Brief introduction	10-2
10.2.2	Unit options	10-3
10.2.3	Display unit setting	10-4
10.2.3.1	User-defined	10-5
10.2.3.2	Auto set.....	10-6
10.2.3.3	Where to apply.....	10-8
10.3	Language switching	10-11
10.3.1	Brief introduction	10-11
10.3.2	Language switching setting.....	10-11
10.4	Help.....	10-12
10.4.1	Brief introduction	10-12
10.4.2	Help setting	10-12
11.	Appendix.....	11-1
11.1	Examples for servo drive configuration	11-2
11.1.1	AC servo motor (EM1 series).....	11-3
11.1.2	DM direct drive motor (RM series).....	11-6
11.1.3	Linear motor	11-10

(This page is intentionally left blank.)

1. Thunder Overview

1.	Thunder Overview.....	1-1
1.1	Brief introduction.....	1-2
1.2	System requirements.....	1-3
1.3	Thunder functions	1-4
1.4	Main window	1-5
1.5	Function list.....	1-6

1.1 Brief introduction

Thunder's system requirements, functions, main window and the list of all functions are introduced in this chapter.

System requirements

The minimum requirement and recommended requirement for the system to operate Thunder are provided in this section. Users can select the appropriate hardware based on actual situation.

Thunder functions

Thunder functions are briefly introduced in this section, including setting and tuning servo drive, monitoring system messages, executing troubleshooting, etc.

Main window

The operation of Thunder main window is introduced in this section to help users get familiar with Thunder quickly.

Function list

All functions in Thunder are listed in this section for users to do quick search.

1.2 System requirements

The minimum requirement and recommended requirement for the system to operate Thunder are given in Table 1.2.1. Users can select the appropriate hardware based on actual situation.

Table 1.2.1

Component	Recommended requirement	Minimum requirement
Supported language	English, Traditional Chinese, Simplified Chinese	English, Traditional Chinese, Simplified Chinese
Operating system	Windows 7, Windows 8.1, Windows 10	Windows 7 or above
CPU clock rate	3 GB or above	1 GB or above
Memory	4 GB RAM or above	2 GB RAM or above
Number of USB port	1 or more	1 or more
Version of USB port	USB 2.0 or above	USB 2.0 or above
Screen	1920x1080 resolution or higher	1366x768 resolution or higher

CAUTION

- ◆ When operating Thunder, use **minimum requirement** or better hardware configuration and operating environment. If the environment for configuration is poor than minimum requirement, unexpected abnormalities may occur.
- ◆ To get a better experience of Thunder, use **recommended requirement** or better hardware configuration and operating environment.

1.3 Thunder functions

Thunder is mainly used in E1 series servo drive's setting and tuning. It is also equipped with the following functions:

- ◆ Provide servo drive related parameters setting.
- ◆ Provide encoder related parameters setting.
- ◆ Provide motor related parameters setting.
- ◆ Do test run.
- ◆ Tune servo drive.
- ◆ Monitor system messages, including servo drive status, Excellent Smart Cube (ESC) status, motor status and other system messages, such as firmware version and communication format.
- ◆ Execute troubleshooting. For example, check and clear malfunctions or errors, provide the reasons, ensure the troubleshooting methods and the steps to solve them.

To get the related technical documents, please download them from HIWIN MIKROSTEM official website (<https://www.hiwinmikro.tw>).

1.4 Main window

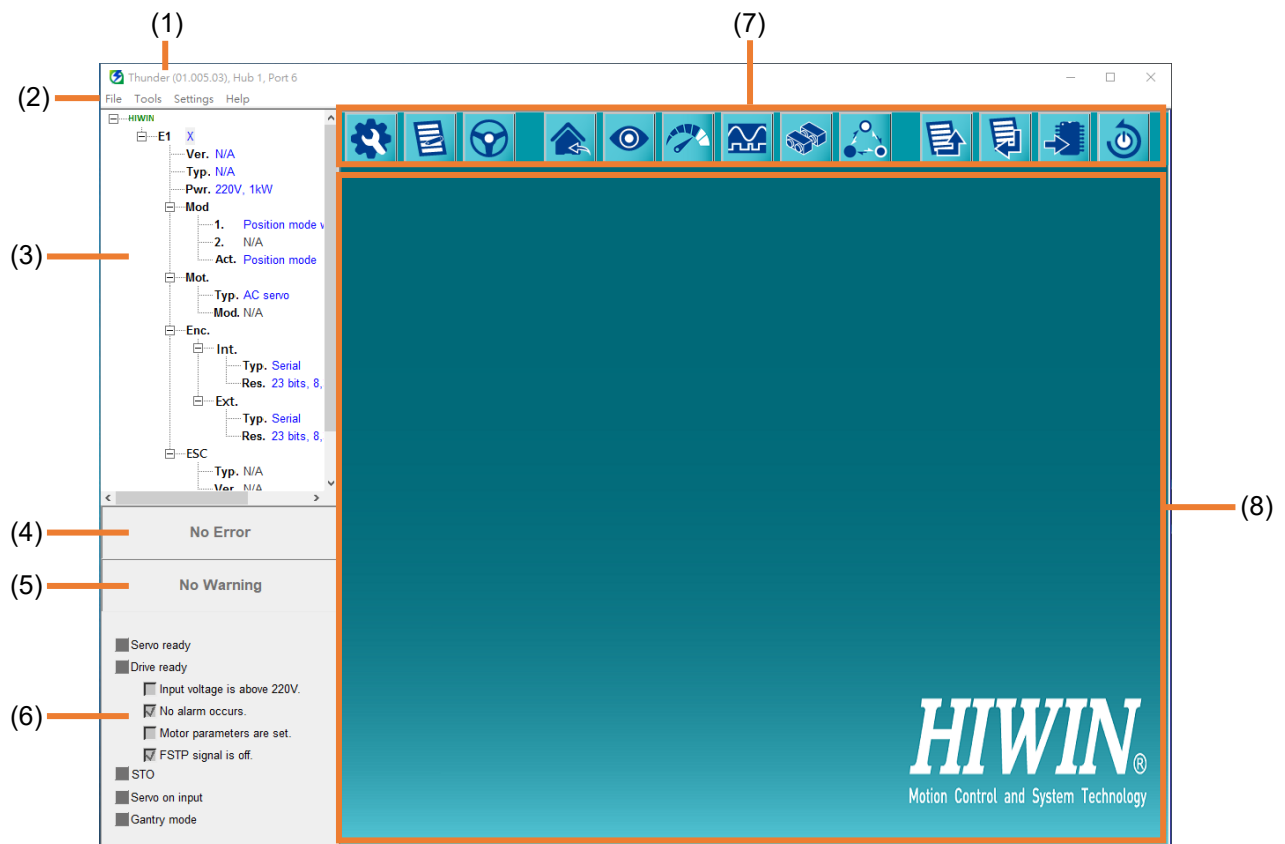

Figure 1.4.1

Table 1.4.1

No.	Item	Description
(1)	Software version	Display Thunder version number.
(2)	Menu bar	Function menu bar, including "File", "Tools", "Settings", and "Help".
(3)	Information column	Display system information, including servo drive's type and firmware version, motor type, encoder type, ESC's type and firmware version.
(4)	Alarm	Display alarm's code and name.
(5)	Warning	Display warning's code and name.
(6)	Status light	Display ready signal, including servo signal, drive signal, STO signal, servo on signal, gantry mode signal.
(7)	Toolbar	Tool menu bar, including "Configuration Wizard", "Parameters Setup", "Test Run", "Homing Operation", "Interface signal monitor", "Performance monitor", "Scope", "PDL", "Multi-motion setting", "Save parameters as a file", "Load parameters from file to drive", "Save to drive" and "Reset drive".
(8)	Main window	Display the page of each function.

1.5 Function list





All functions in Thunder are listed in this section for users to do quick search. Table 1.5.1 is about functions in menu bar, and Table 1.5.2 is about functions in toolbar.

Table 1.5.1

Thunder main window	Menu bar	File		Load prm file				
				Save prm as a file				
		Tools		Communication setup				
				Phase initialization setup				
				Auto tune				
				Absolute encoder initialization				
				Analog offset				
				Dynamic brake resistor wizard				
				Gantry control system				
				Tuneless				
				Error map setup				
				I/O configuration				
				Real-time data collection				
				Spectrum analyzer				
				Error log				
				Messages + command prompt				
				Set to factory default				
		Update firmware						
		Settings		Language		English		
						Traditional Chinese		
						Simplified Chinese		
						Japanese (not supported yet)		
		Settings		Display unit		Linear unit		um
								mm
						Rotary unit		cm
								m
m (m/min)								
rad								
Settings				Display unit		Rotary unit		milrad
								deg
		rev						
		rev						



				Others	ctrl unit		
					Display unit setting		
		Access (only available for Fieldbus servo drives)			Thunder		
					Controller		
		Help			User guide		
					About		

Table 1.5.2

Thunder main window	Toolbar		(Open Configuration Wizard)	Configuration Wizard	Power Setup	
					Motor Setup	
					Encoder Setup	
					Control Mode Setup	
					Command Input Setup	
					Emulated Encoder Output Setup	
					I/O configuration	
					Send to drive	
			(Open Parameters Setup)	Parameters Setup	Diff.	Parameter comparison
					Pt0XX	For setting basic function
					Pt1XX	For tuning
					Pt2XX	Position-related
					Pt3XX	Velocity-related
					Pt4XX	Torque-related
					Pt5XX	For I/O setting
					Pt6XX	For regenerative resistor setting
Pt7XX	For internal homing					
Others	User-defined page					
	(Open Test Run)	Test Run	Position mode			
			Velocity mode			
	(Open Homing Operation)	Homing Operation	Method1	Homing on negative limit switch and index pulse (search for index signal on the right side of N-OT signal)		
			Method2	Homing on positive limit switch and index pulse (search for index signal on the left side of P-OT signal)		

					Method7	Homing on home switch and index pulse – positive initial move (search for index signal on the left side of DOG signal’s rising edge)
					Method8	Homing on home switch and index pulse – positive initial move (search for index signal on the right side of DOG signal’s rising edge)
					Method9	Homing on home switch and index pulse – positive initial move (search for index signal on the left side of DOG signal’s falling edge)
					Method10	Homing on home switch and index pulse – positive initial move (search for index signal on the right side of DOG signal’s falling edge)
					Method11	Homing on home switch and index pulse – negative initial move (search for index signal on the right side of DOG signal’s rising edge)
					Method12	Homing on home switch and index pulse – negative initial move (search for index signal on the left side of DOG signal’s rising edge)
					Method13	Homing on home switch and index pulse – negative initial move (search for index signal on the right side of DOG signal’s falling edge)







					Method14	Homing on home switch and index pulse – negative initial move (search for index signal on the left side of DOG signal's falling edge)
					Method33	Homing on index pulse – negative initial move
					Method34	Homing on index pulse – positive initial move
					Method35	Homing on current position
					Method37	Homing on current position (same as method35)
					Method-3	Homing on current position (absolute encoder only)
					Method-6	Homing on home position (absolute encoder only)
		 (Open Interface signal monitor)	Monitor servo drive's signal status	Internal status	(1) Bus voltage (2) Serial encoder (3) AqB encoder (4) Encoder 5V (5) Motor current (6) U, V, W-current	
				I/O signal status	(1) Pulse input (2) AqB output (3) V-REF (4) T-REF (5) Digital input signal (I1~I10) (6) Digital output signal (O1~O5) (7) AO1, AO2	
				ESC	(1) Thermal sensor (TS) (2) Lissajous	
					Gantry control system	Gantry signal light

			<p>(Open performance monitor)</p>	<p>Performance monitor</p>	<p>Display motor motion's status and performance. By modifying servo drive's parameters, users can observe the change of motion's performance.</p>
			<p>(Open Scope)</p>	<p>Scope</p>	<p>Physical quantity</p> <ul style="list-style-type: none"> (1) Position error (2) Feedback position (3) Position reference velocity (4) Motor-Load position deviation (5) Velocity feedforward (6) Reference velocity (7) Motor velocity (8) Torque feedforward (9) Torque reference (10) Command current (11) Motor current (12) Servo voltage percentage (13) Digital hall signal (14) Motor overload protection (15) Position amplifier error (16) Velocity error (17) Master feedback position (18) Slave feedback position (19) Yaw position (20) Run position command (21) Effective gain (22) Internal feedback position (23) Gantry linear command current (24) Gantry yaw command current (25) Gantry yaw position error

						<p>(51) S-ON //servo on input signal</p> <p>(52) P-CON //proportional control input signal</p> <p>(53) P-OT //forward prohibition input signal</p> <p>(54) N-OT //reverse prohibition input signal</p> <p>(55) ALM-RST //alarm reset input signal</p> <p>(56) P-CL //forward external torque limit input signal</p> <p>(57) N-CL //reverse external torque limit input signal</p> <p>(58) C-SEL //control method switching input signal</p> <p>(59) SPD-D //motor rotation direction input signal</p> <p>(60) SPD-A //internal set velocity input signal</p> <p>(61) SPD-B //internal set velocity input signal</p> <p>(62) ZCLAMP //zero clamp input signal</p> <p>(63) INHIBIT //command pulse inhibition input signal</p> <p>(64) G-SEL //gain switching input signal</p> <p>(65) PSEL //command pulse multiplication switching input signal</p> <p>(66) RST //servo drive reset input signal</p> <p>(67) DOG(DEC) //near home sensor input signal</p> <p>(68) HOM //servo drive built-in homing</p>
--	--	--	--	--	--	---

Servo
signal
status

						procedure input signal
					(69)	MAP //servo drive error map input signal
					(70)	FSTP //forced stop input signal
					(71)	CLR //position deviation clear input signal
					(72)	ALM //alarm output signal
					(73)	COIN //positioning completion output signal
					(74)	V-CMP //velocity reach output signal
					(75)	TGON //rotation detection/movement detection output signal
					(76)	D-RDY //drive ready output signal
					(77)	S-RDY //servo ready output signal
					(78)	CLT //torque limit detection output signal
					(79)	VLT //velocity limit detection output signal
					(80)	BK //brake control output signal
					(81)	WARN //warning output signal
					(82)	NEAR //positioning near output signal
					(83)	PSELA //command pulse multiplication switching output signal
					(84)	PT //position trigger digital output signal

					<p>(85) DBK //external dynamic brake output signal</p> <p>(86) HOMED //servo drive homing completion output signal</p> <p>(87) PAO //encoder divided pulse output signal-A phase</p> <p>(88) PBO //encoder divided pulse output signal-B phase</p> <p>(89) PZO //encoder divided pulse output signal-Z phase</p> <p>(90) INDEX //index signal</p>
		(Open PDL)	PDL	Process description language	
		(Open multi-motion setting)	Multi-motion setting	Motion type	<p>(1) Absolute Move</p> <p>(2) Relative Move</p> <p>(3) Indexing movement-1 (Reset method: next motion)</p> <p>(4) Indexing movement-2 (Reset method: nearest motion)</p> <p>(5) JOG</p> <p>(6) Homing</p> <p>(7) Customized motion</p>
		(Save parameters as a file)	Save servo drive parameters file (*.prm)	Back up parameters as a file to PC.	
		(Load parameters from file to drive)	Load servo drive parameters file (*.prm)	Reload parameters file back to servo drive.	
		(Save to drive)	Send the parameters to servo drive	Temporarily save parameters file to memory.	
		(Reset drive)	Reset drive	Power cycle servo drive.	

(This page is intentionally left blank.)

2. Install Thunder

2.	Install Thunder	2-1
2.1	Brief introduction	2-2
2.2	Download Thunder	2-3
2.3	Install Thunder	2-7
2.4	Install USB driver	2-11
2.5	Remove Thunder	2-16

2.1 Brief introduction

This chapter explains the way to download, install, repair and remove Thunder software from official website. Users can also install USB driver based on the instructions given in this chapter.

Download Thunder

Users can download Thunder installation file from official website.

Install Thunder

A step-by-step guide for users to complete Thunder installation is provided in this section.

Install USB driver

A step-by-step guide for users to complete USB driver installation is provided in this section.

Remove Thunder

The ways to remove Thunder are provided in this section.

Method 1: Remove it via the installation file downloaded from official website.

Method 2: Remove it via the application in console.

2.2 Download Thunder

Follow the procedure below to install Thunder installation file from HIWIN MIKROSYSTEM official website.

1. Open the browser, connect to HIWIN MIKROSYSTEM official website (<https://www.hiwinmikro.tw>), and click **Download**.

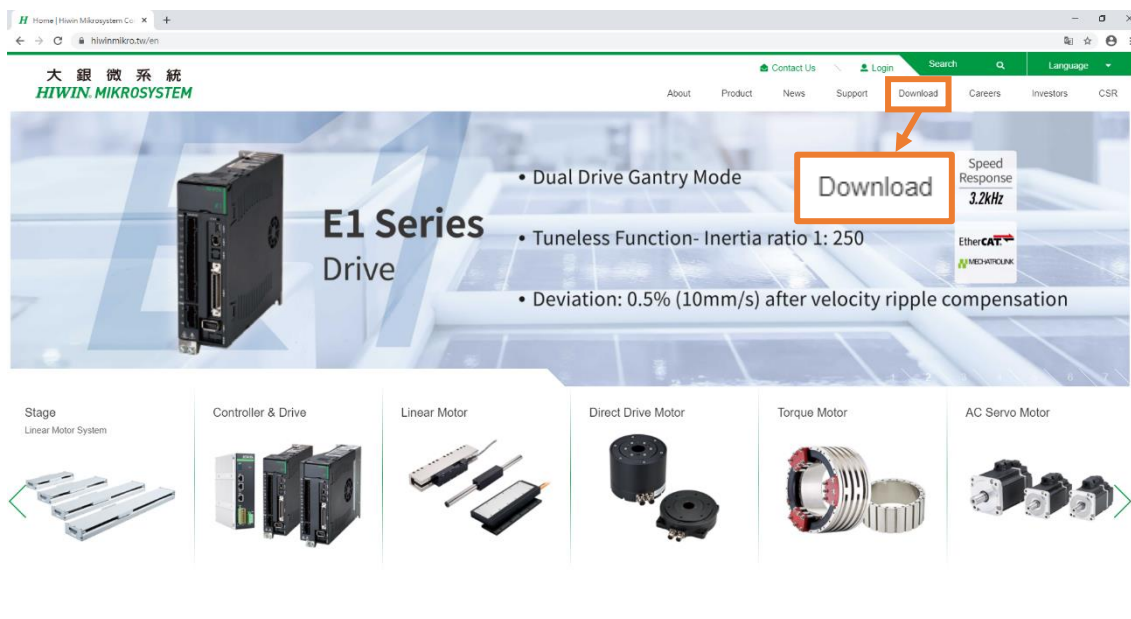

Figure 2.2.1

2. Find the file type on the screen and select **Software**.

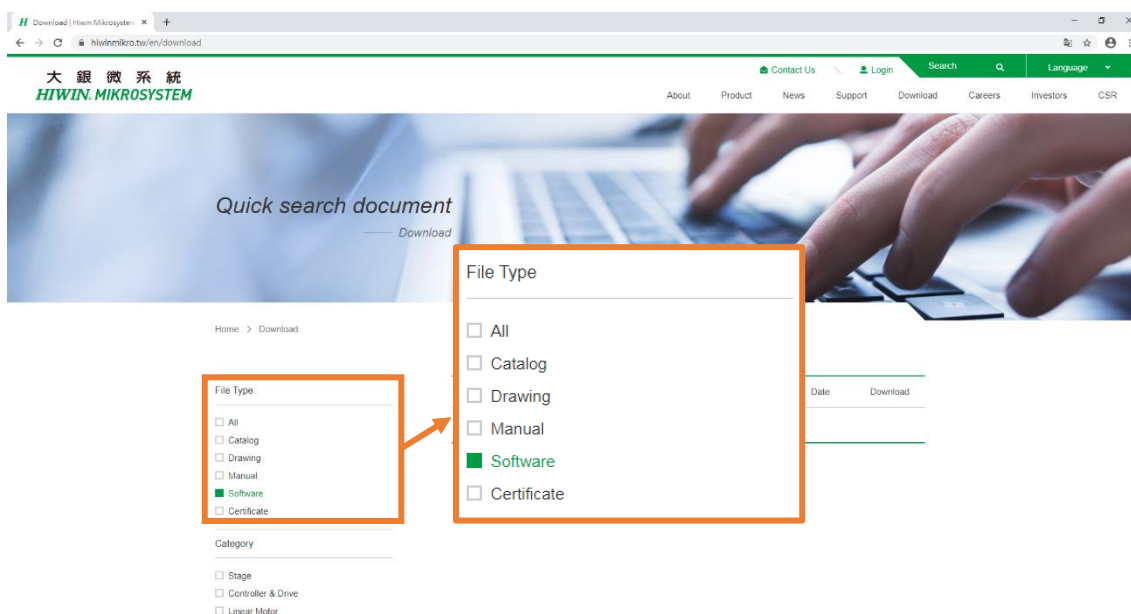

Figure 2.2.2

3. Find the category on the screen and select **Controller & Drive**.

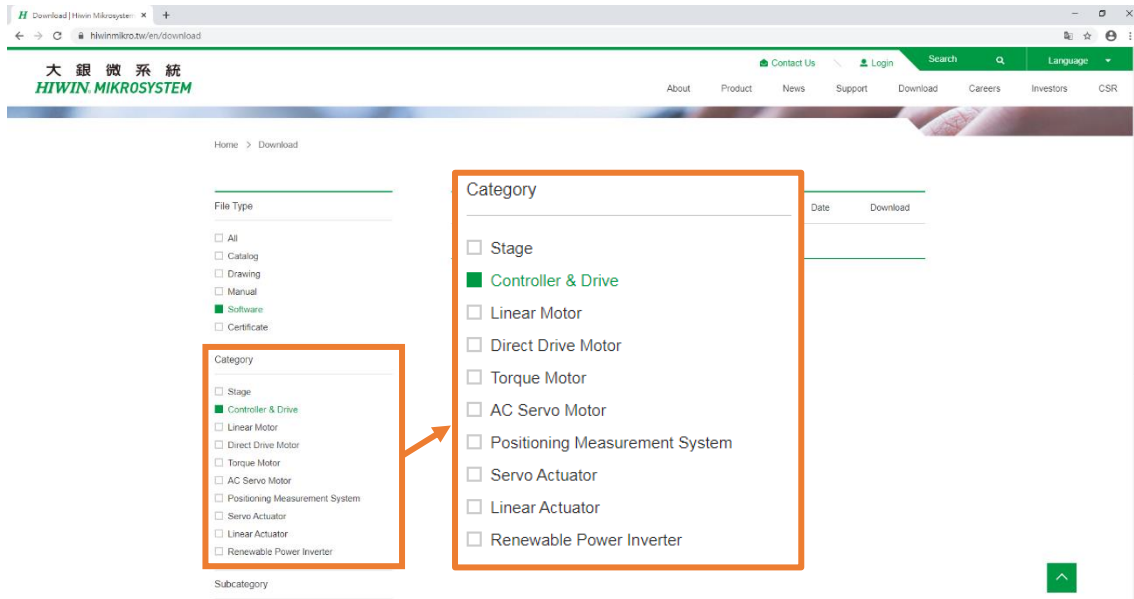

Figure 2.2.3

4. Find the subcategory on the screen and select **Drive E1**.

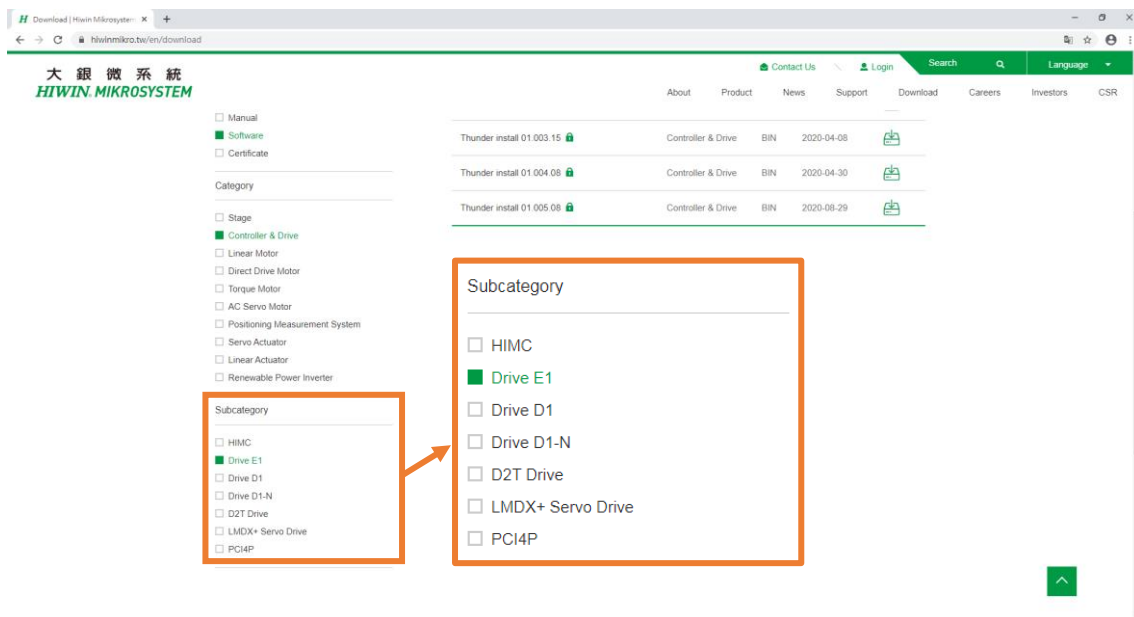



Figure 2.2.4

5. Find the Thunder installation file on the screen, and select one of the versions. Here takes version 1.5.10.0 as an example. Click the icon beside Thunder install 1.5.10.0  to start the installation.

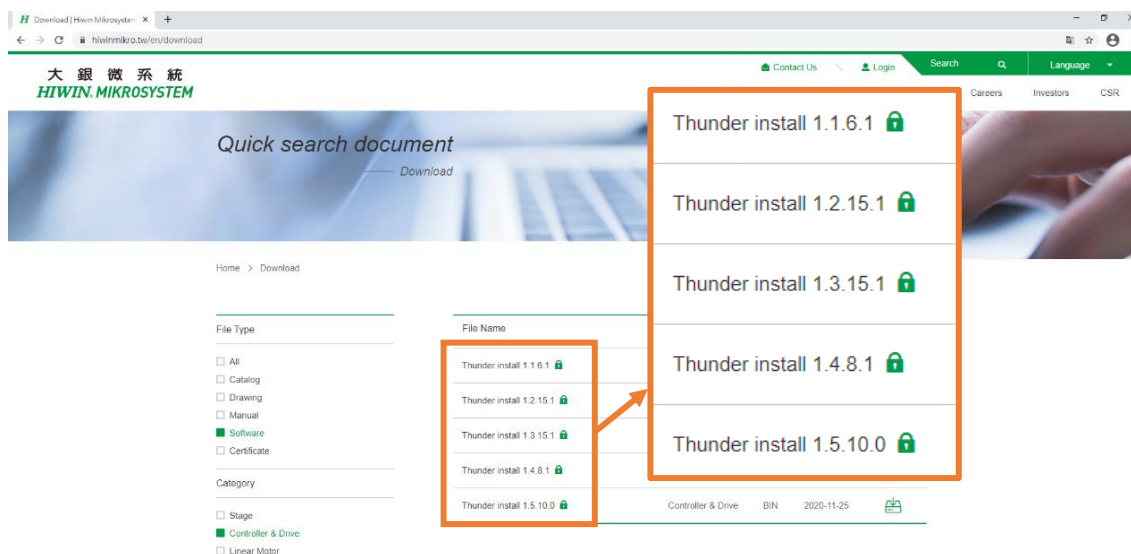

Figure 2.2.5

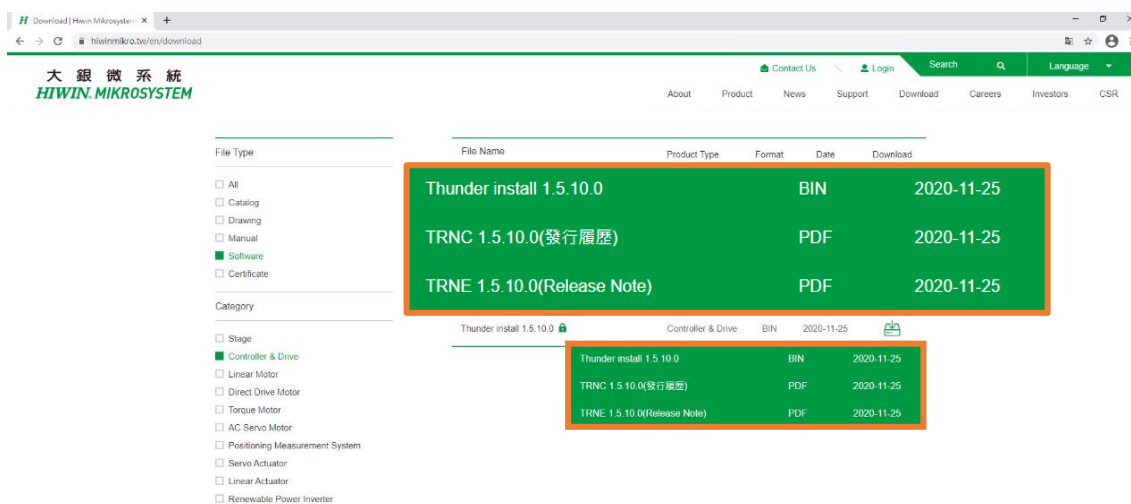

Figure 2.2.6

Table 2.2.1

Thunder version	Firmware version for standard servo drive	Firmware version for Fieldbus servo drive
1.1.6.1	2.1.8	2.1.8
1.2.15.1	2.2.8	2.2.8
1.3.15.1	2.3.12	2.3.12
1.4.8.1	2.4.6	2.4.6
1.5.10.0	2.5.6	2.5.6 / 2.5.7
1.6.11.0	2.6.11	2.6.11

⚠ CAUTION

- ◆ If users cannot connect to Internet or download the software, please contact your information technology center or the related department for troubleshooting first.
- ◆ To avoid download interruption or page display errors during the download process, use standard browser, such as IE, Google Chrome and Mozilla Firefox.
- ◆ Some files can only be downloaded when users have the membership. Login first before operation.

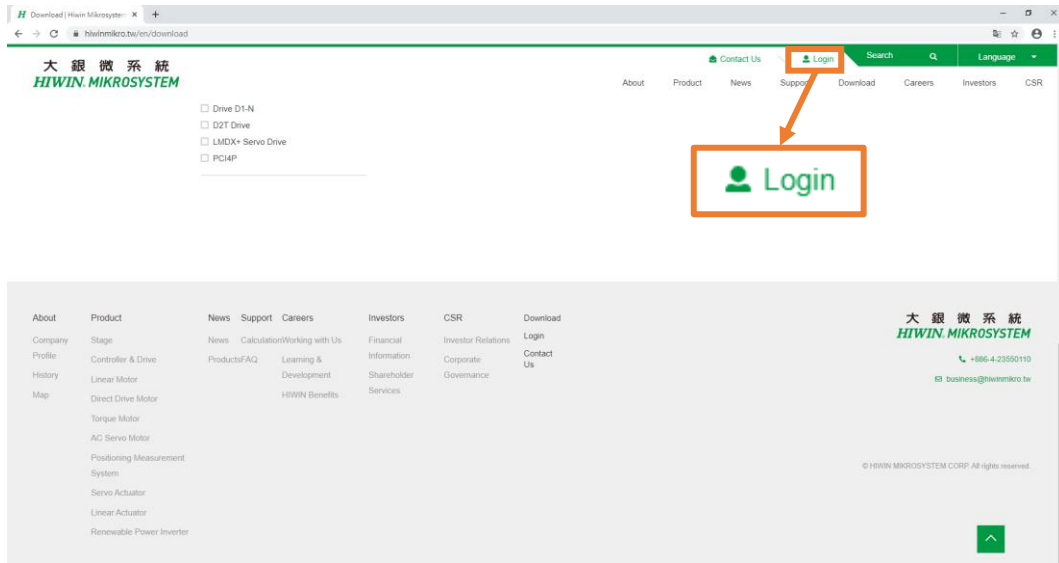

Figure 2.2.7

- ◆ If users haven't had the membership, join the member first. After the registration, users can download the files.

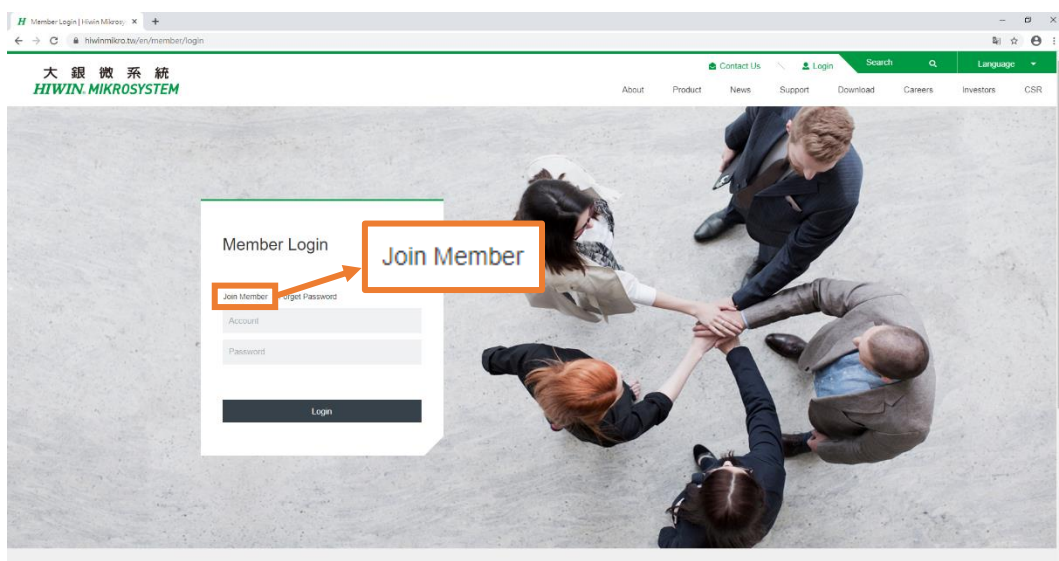

Figure 2.2.8

- ◆ If users have any question about registration or download, feel free to contact us.

2.3 Install Thunder

Here takes Thunder install 1.5.10.0 as an example.



Information

Before installation, ensure if there are important settings in old Thunder. If there are, make a backup first, since new Thunder will overwrite old Thunder's data.

Follow the procedure below to install Thunder.

1. Find the Thunder installation file downloaded from official website.

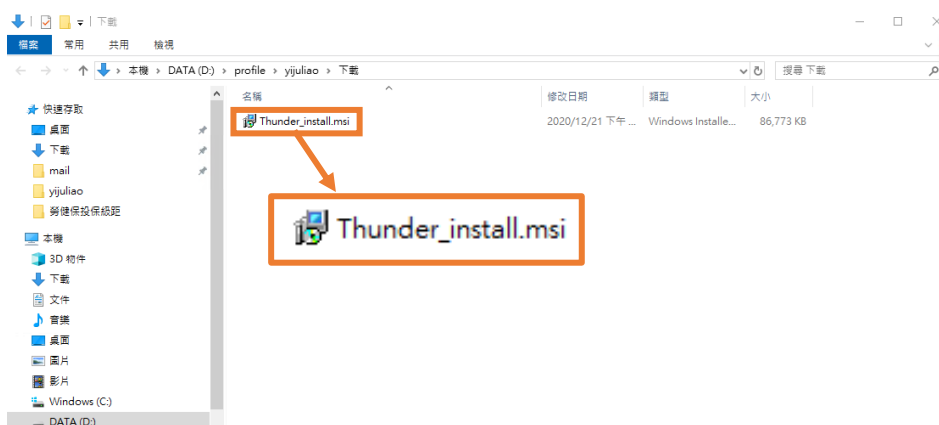

Figure 2.3.1

2. Open Thunder installation file, and click **Next** to execute the installation.

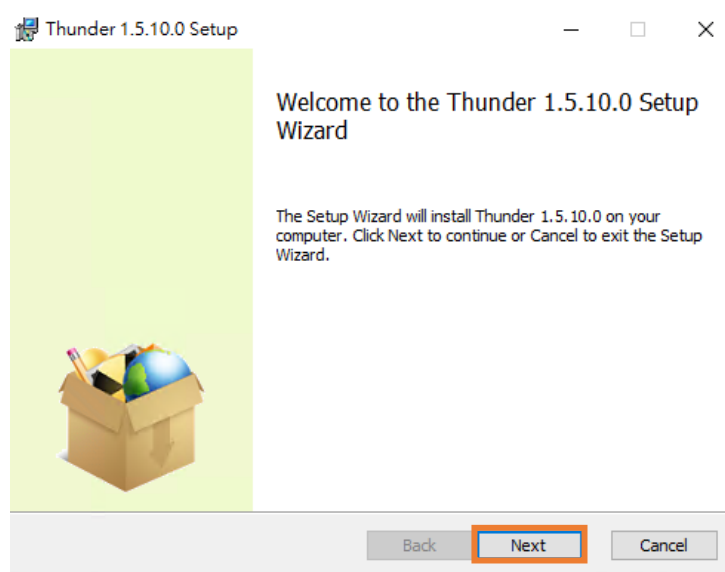

Figure 2.3.2

3. Click **Next** to continue the installation.

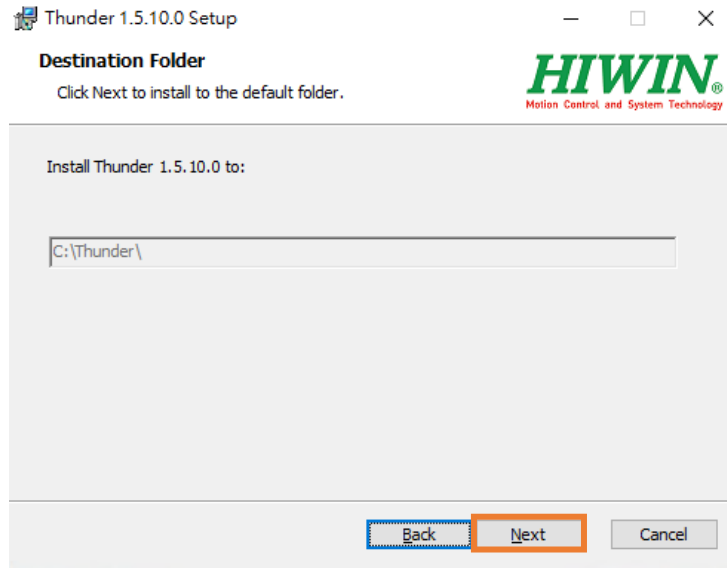

Figure 2.3.3

4. Click **Install** to continue the installation.

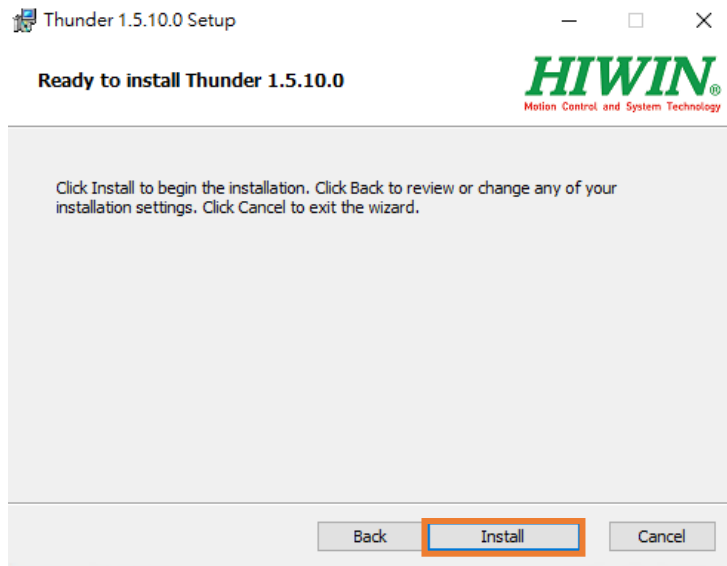

Figure 2.3.4

5. Wait until the installation is done.

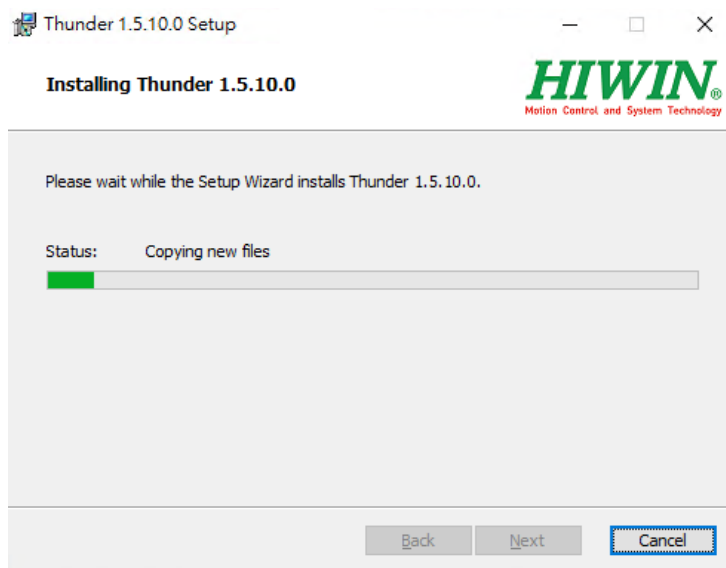

Figure 2.3.5

6. Click **Finish** to complete the installation.

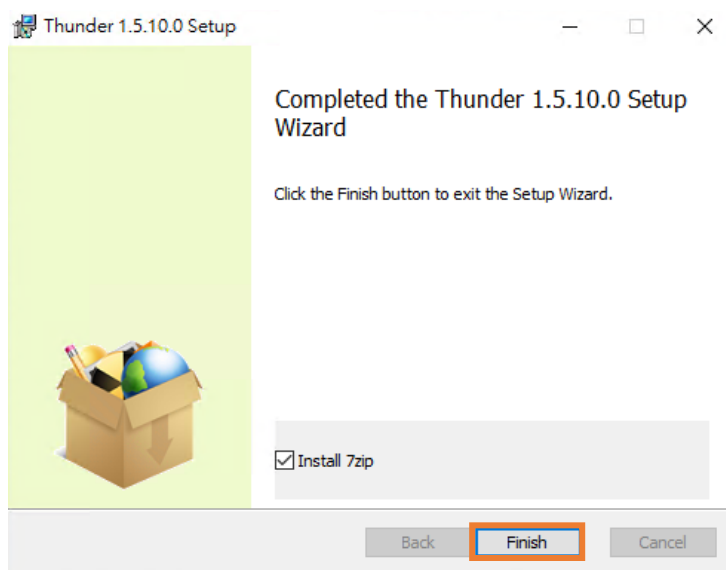

Figure 2.3.6

⚠ CAUTION

- ◆ Some functions in Thunder software must be equipped with 7zip. If users do not install the decompression software for 7zip, check **Install 7zip**.

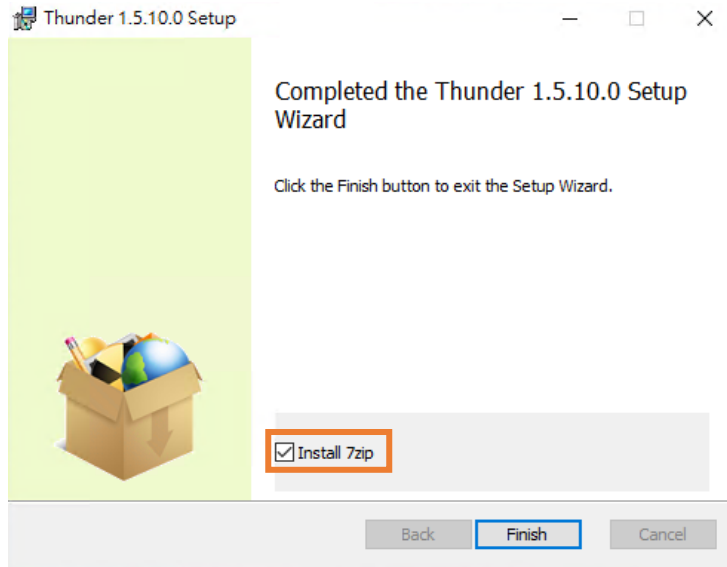

Figure 2.3.7

2.4 Install USB driver

After installing Thunder, users must install USB driver for building the communication with servo drive. Here takes Windows 10 operating system as an example to explain the way of installing USB driver.



Important

Before installing USB driver, power on the servo drive and connect to PC via USB.

Follow the procedure below to install USB driver.

1. Open “Device Manager”.

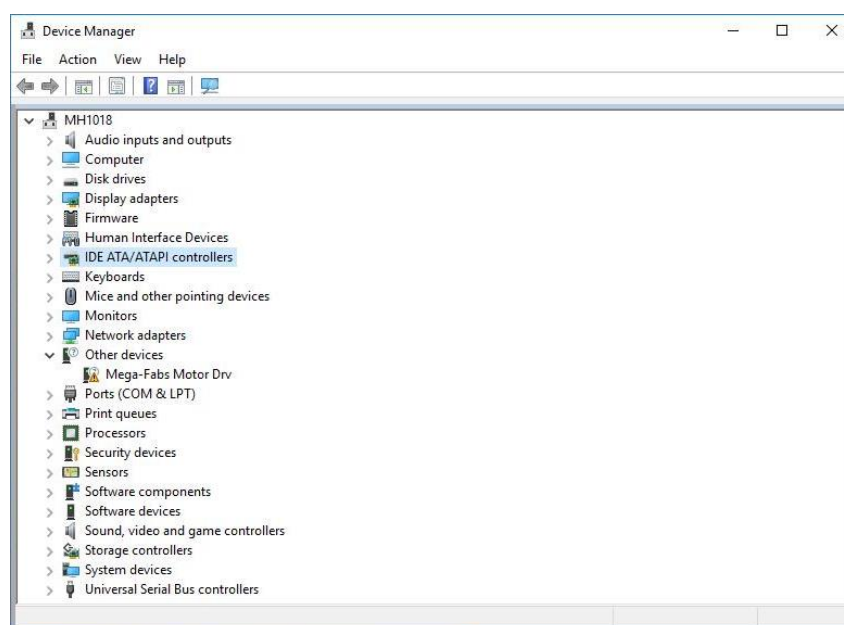

Figure 2.4.1

2. After entering “Device Manager”, right-click **Mega-Fabs** device and select **Update driver**.



Important

Before executing the update of driver, ensure if you have administrator authority. The update of driver must be performed under administrator authority.

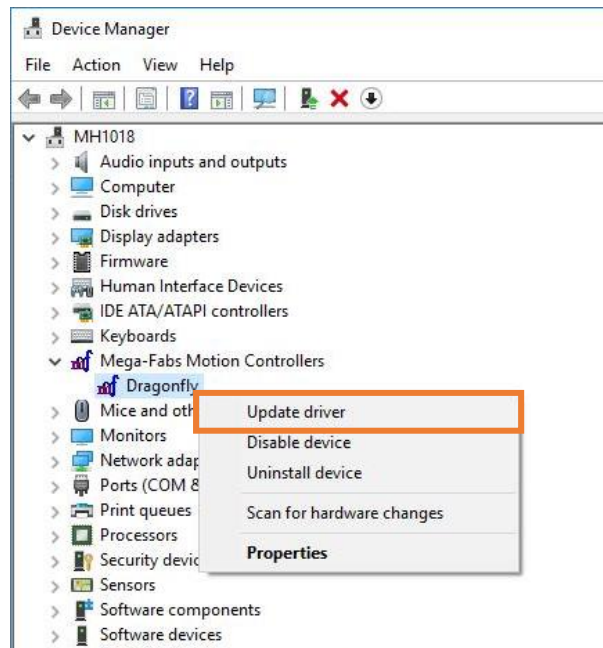

Figure 2.4.2

3. Select **Browse my computer for driver software**.

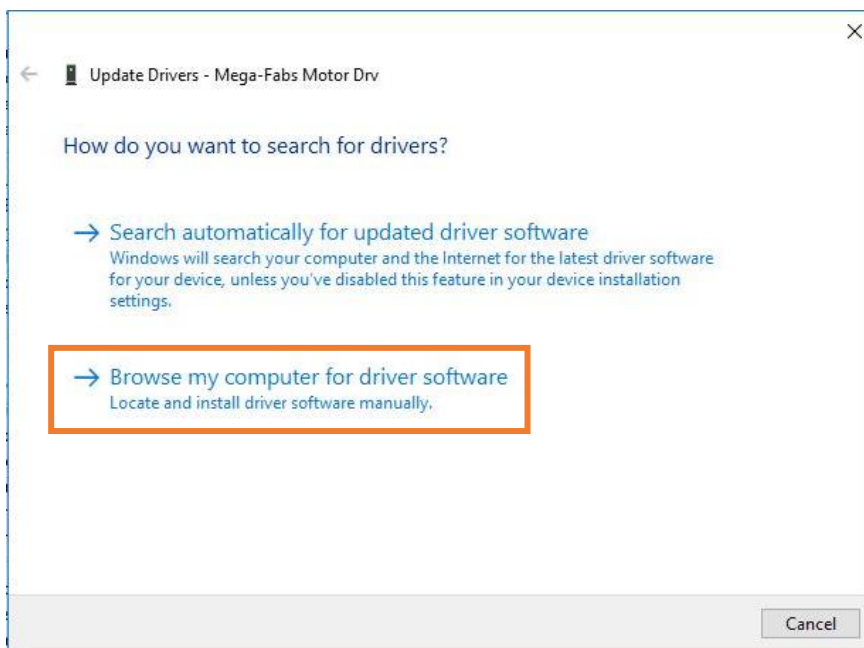

Figure 2.4.3

4. Click **Browse** to select folder path.

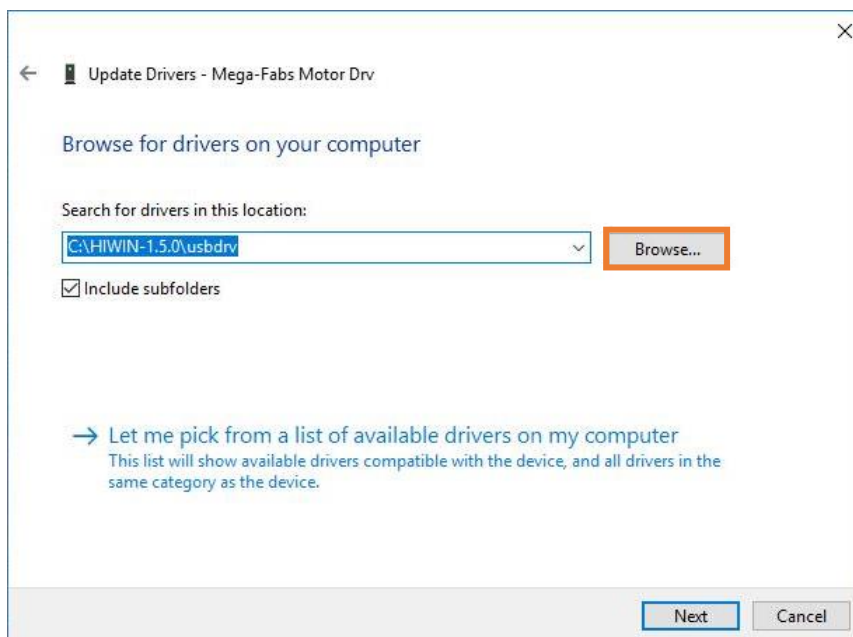

Figure 2.4.4

5. Select **C:\Thunder\usbdrv** as the path where Thunder USB driver exists, and click **OK**.

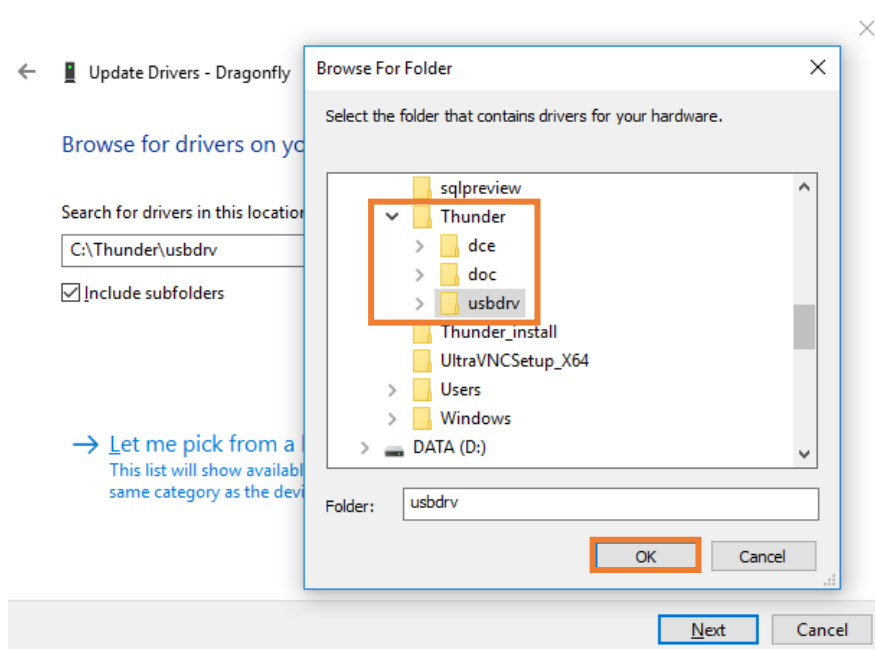

Figure 2.4.5

6. After selecting the path, click **Next**.

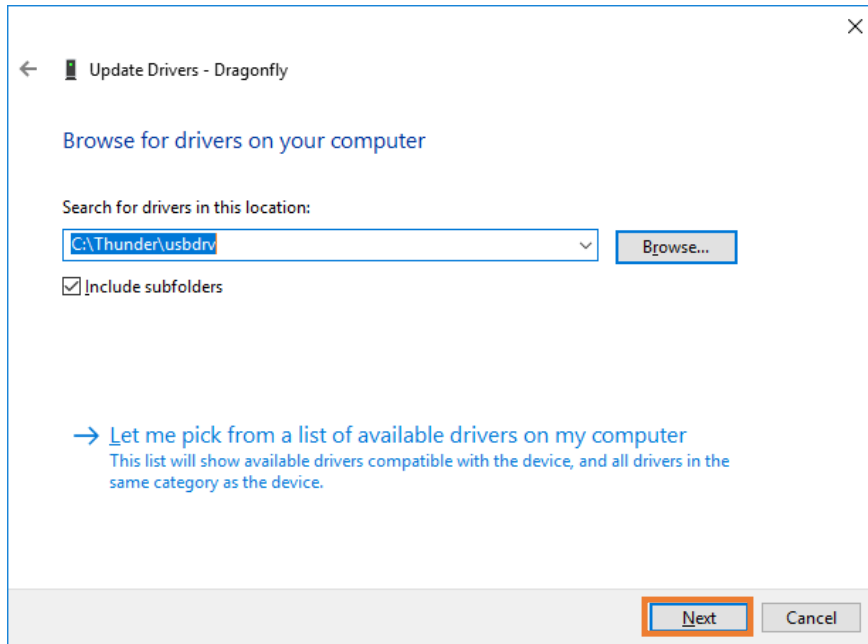

Figure 2.4.6

7. The installation is completed. Click **Close** after the confirmation.

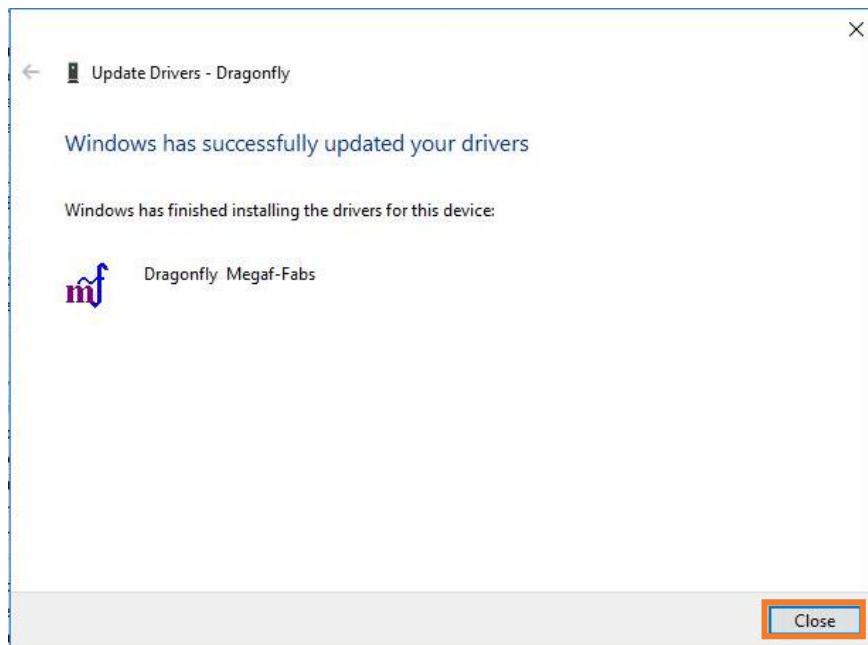

Figure 2.4.7

8. It's the confirmation screen of successful installation.

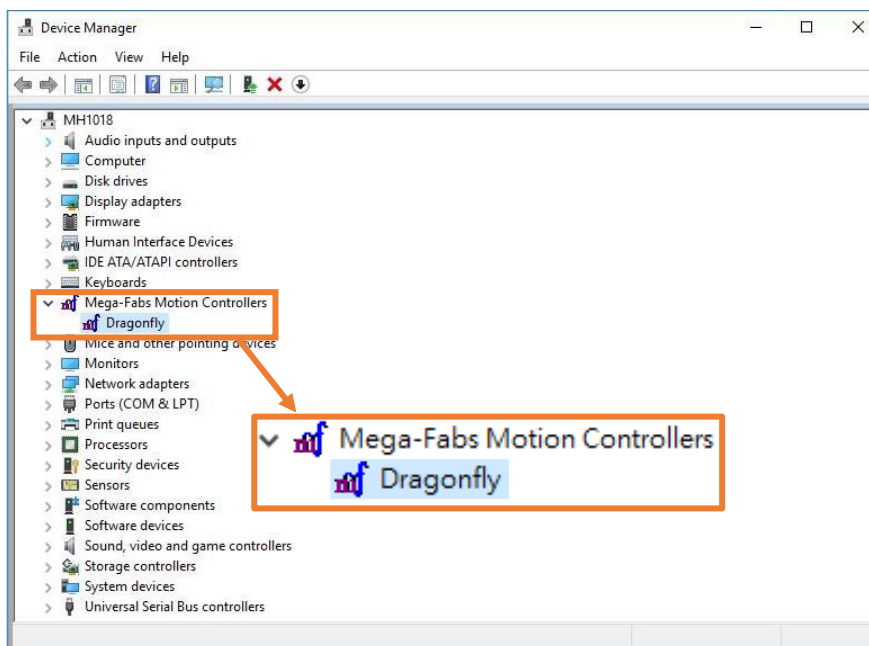

Figure 2.4.8

2.5 Remove Thunder

There are two ways to remove Thunder software after the installation:

- ◆ Remove it via the installation file downloaded from official website.
- ◆ Remove it via the application in console.

Here takes Windows 10 operating system as an example to remove Thunder software via the installation file downloaded from official website.

Follow the procedure below to remove Thunder.

1. Find the Thunder installation file downloaded from official website.

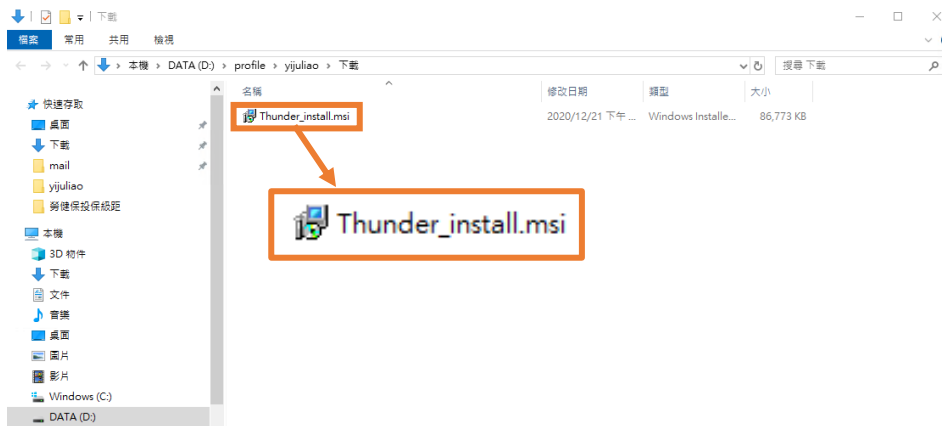

Figure 2.5.1

2. Open Thunder installation file, and click **Next** to execute the removal.

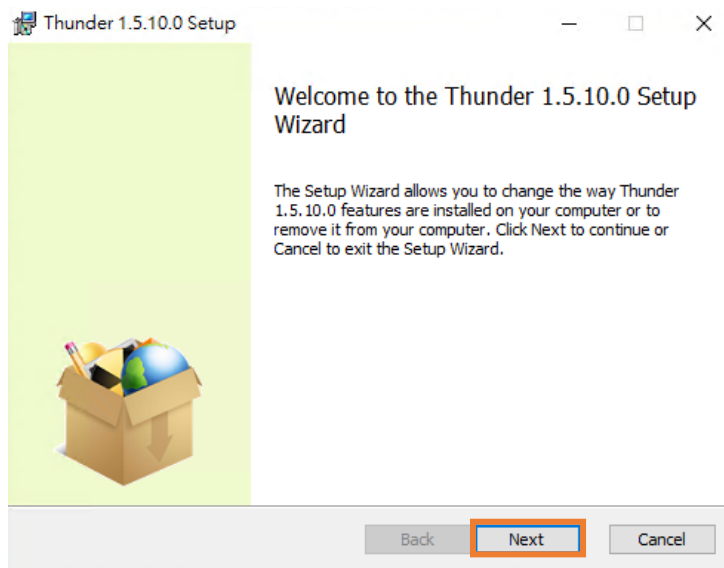

Figure 2.5.2

3. Click **Remove** to continue the removal.

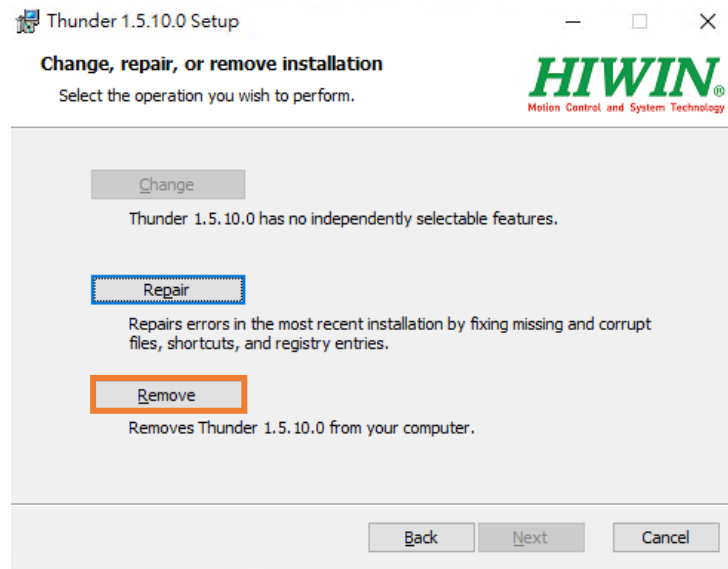

Figure 2.5.3

4. Click **Remove** to continue the removal.

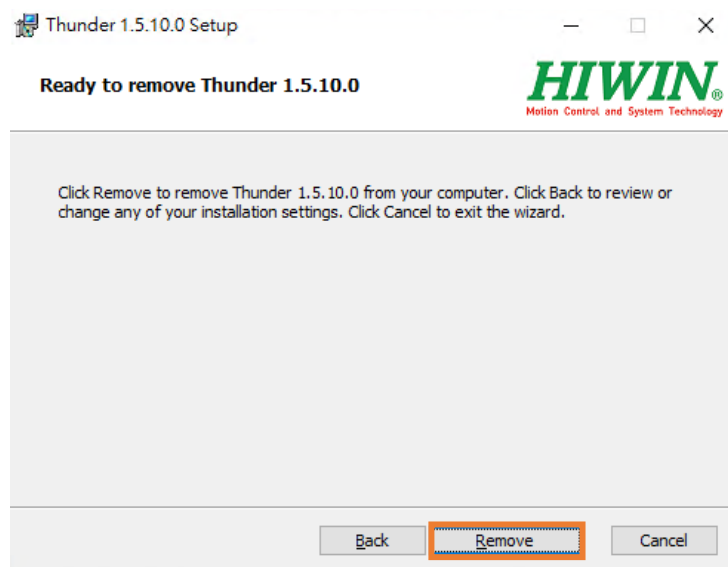

Figure 2.5.4

5. Wait until the removal is done.

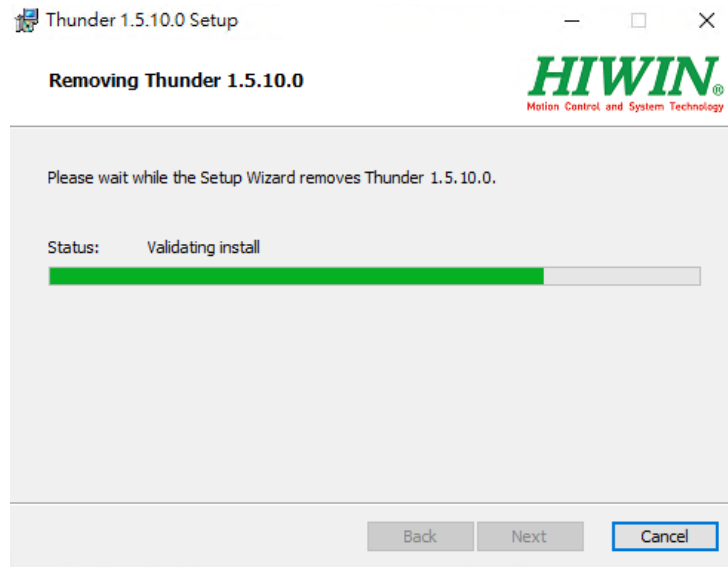

Figure 2.5.5

6. Click **Finish** to complete the removal.

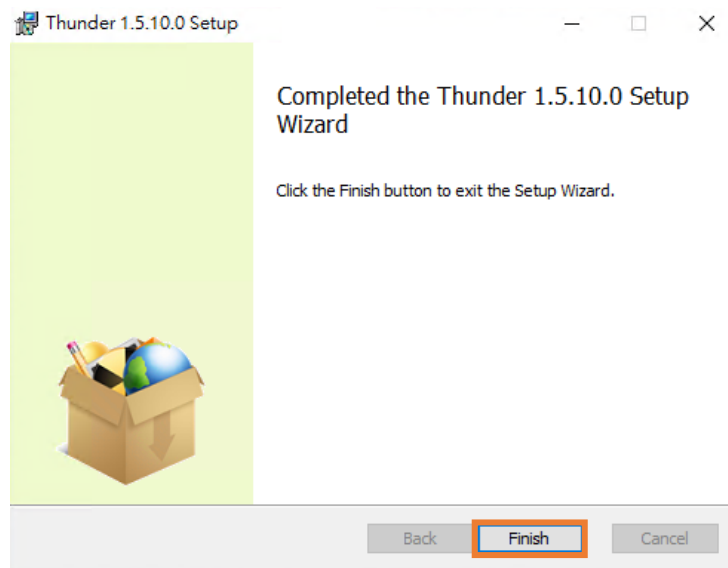

Figure 2.5.6

3. Start Thunder

3.	Start Thunder	3-1
3.1	Brief introduction	3-2
3.2	Connection and communication settings	3-3
3.2.1	Brief introduction	3-3
3.2.2	Connect via USB	3-4
3.2.3	Connect via mega-ulink	3-6
3.2.3.1	Multi-axes connection	3-6
3.2.3.2	Switch to different axis	3-9
3.2.3.3	Modify axis name	3-10
3.2.4	Off-line mode	3-11
3.3	Mastership switching	3-14
3.3.1	From Controller to Thunder	3-15
3.3.2	From Thunder to Controller	3-16
3.4	Update firmware	3-17

3.1 Brief introduction

This chapter explains how to start Thunder, including servo drive's connection and communication settings, mastership switching and firmware updating.

Connection and communication settings

Users can select the desired connecting method, such as USB, mega-ulink or off-line mode (view parameters only).

Mastership switching

Users can switch the mastership between host controller and Thunder via HMI.

Update firmware

Users can update servo drive's firmware via Thunder.

3.2 Connection and communication settings

3.2.1 Brief introduction

Users can select different connecting method based on different application. Communication modes supported by each model are listed in Table 3.2.1.1.

Table 3.2.1.1

Communication mode Servo drive model	Off-line (View only)	USB	mega-ulink
Standard servo drive ED1S	V	V	X
Fieldbus servo drive (mega-ulink) ED1F-H	V	V	V
Fieldbus servo drive (Other) ED1F	V	V	X



Information

Refer to section 2.1 in “E1 Series Servo Drive User Manual” for the detailed descriptions of servo drive model.

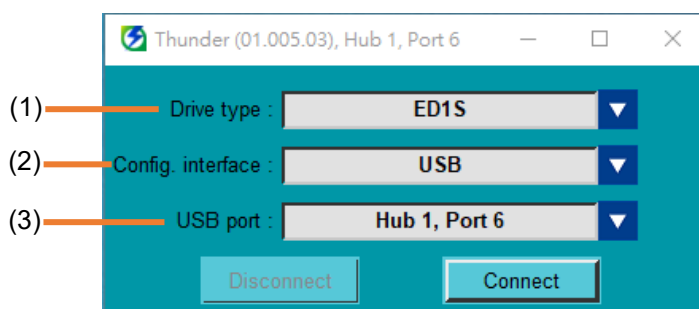

Figure 3.2.1.1

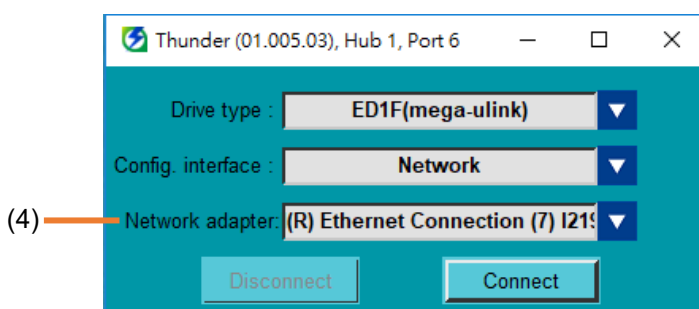

Figure 3.2.1.2

Table 3.2.1.2

No.	Item	Description
(1)	Drive type	Offer servo drive type for users to select: ED1S, ED1F (mega-ulink), ED1F (Other)
(2)	Config. interface	Different servo drive has different configuration interface. ED1S, ED1F (Other): Off-line (View only), USB ED1F (mega-ulink): Off-line (View only), USB, Network
(3)	USB port	After USB is selected in Config. interface, the corresponding USB ports of all connected servo drives will be listed here.
(4)	Network adapter	After Network is selected in Config. interface, all network adapters on the computer will be listed here.

The setting methods of these three communication modes are described in this chapter. Refer to the following table for the related information.

Table 3.2.1.3

Communication mode	Reference
Connect via USB	section 3.2.2
Connect via mega-ulink	section 3.2.3
Off-line mode (view parameters only)	section 3.2.4

3.2.2 Connect via USB

Users can connect Thunder to servo drive via USB.



Information

- (1) This method is only available for the computer with USB interface.
- (2) Connect USB cable to servo drive's CN3.
- (3) If Thunder is disconnected, the servo drive will automatically be disabled.

Follow the procedure below to connect Thunder to servo drive via USB.

1. Select servo drive type.

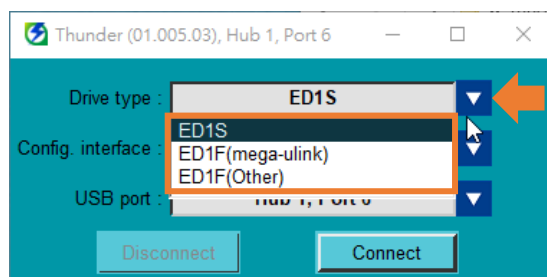

Figure 3.2.2.1

2. Select **USB** in Config. interface.

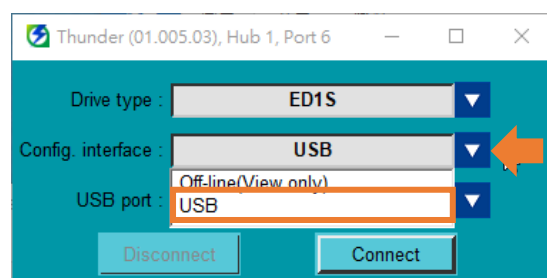

Figure 3.2.2.2

3. Select the USB port actually connected to the servo drive.

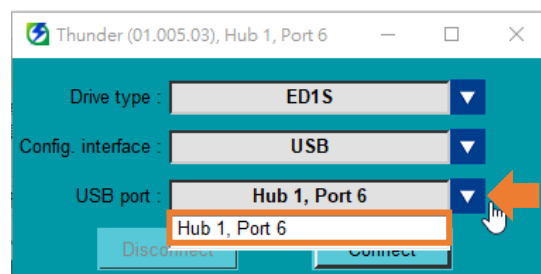

Figure 3.2.2.3

4. Click **Connect**.

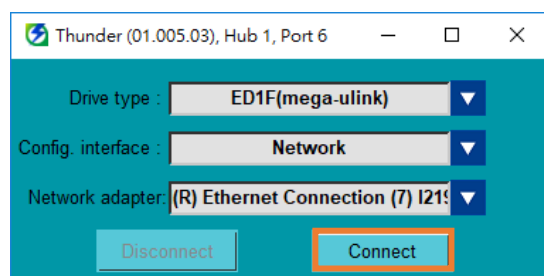

Figure 3.2.2.4

5. If the system information is shown in the information column, it indicates USB connection succeeds.



Figure 3.2.2.5

3.2.3 Connect via mega-ulink

Users can perform single-axis connection or multi-axes connection via mega-ulink communication. Thunder also provides the function of switching to different axis and modifying axis name.

Table 3.2.3.1

Item	Reference
Multi-axes connection	section 3.2.3.1
Switch to different axis	section 3.2.3.2
Modify axis name	section 3.2.3.3

3.2.3.1 Multi-axes connection

Users can connect Thunder to servo drive via mega-ulink. Before doing the connection, ensure the servo drive belongs to Fieldbus type mega-ulink model (ED1F-H), and connect the computer and servo drive's CN9-IN with network cable.

Users can connect servo drives in serial with network cable for multi-axes connection (up to 32 axes).



Information

There are two communication ports on CN9, OUT port and IN port.

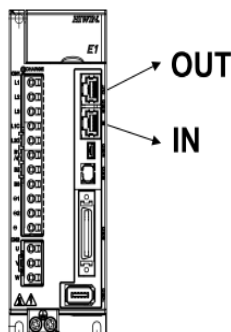

Figure 3.2.3.1.1

OUT: Connect to the IN port on other servo drive or other slave.

If the servo drive is the last station, do not connect to this port.

IN: Connect to controller (master), OUT port on other servo drive or other slave.

Here takes connecting two servo drives in serial as an example. Follow the procedure below to build the multi-axes connection via mega-ulink.

1. Open Thunder, select **ED1F (mega-ulink)** in Drive type.

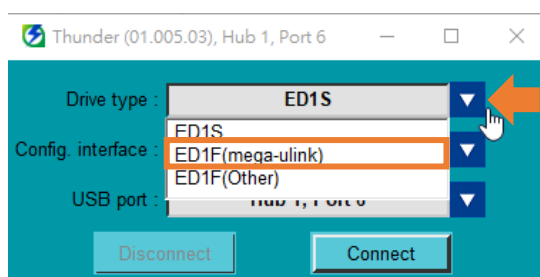

Figure 3.2.3.1.2

2. Select **Network** in Config. interface.

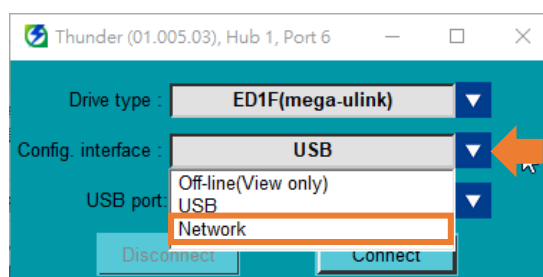

Figure 3.2.3.1.3

3. Select the network adapter actually connected to the servo drive.

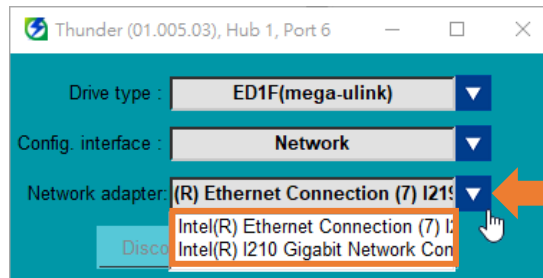

Figure 3.2.3.1.4

4. Click **Connect**.

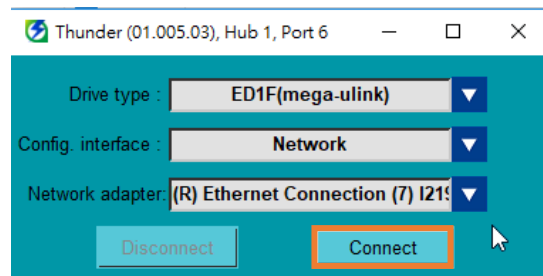

Figure 3.2.3.1.5

5. Go to information column to check if the multi-axes connection succeeds.

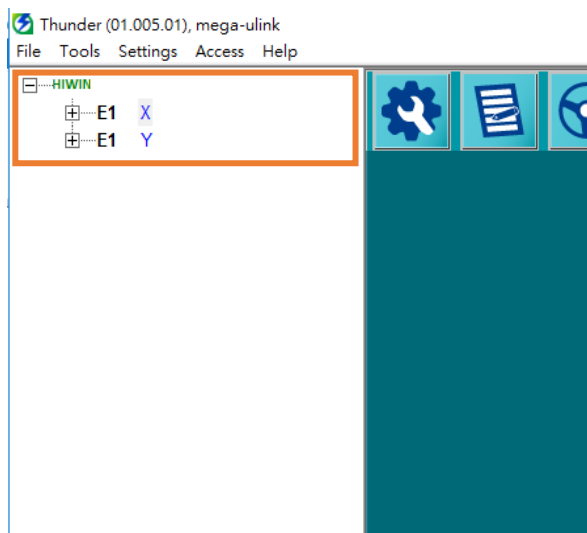

Figure 3.2.3.1.6

3.2.3.2 Switch to different axis

Users can click the axis name in the tree-like information column to switch to different axis. Here takes two axes, X axis and Y axis, as an example. Follow the procedure below to perform switching.

1. The default is X axis.

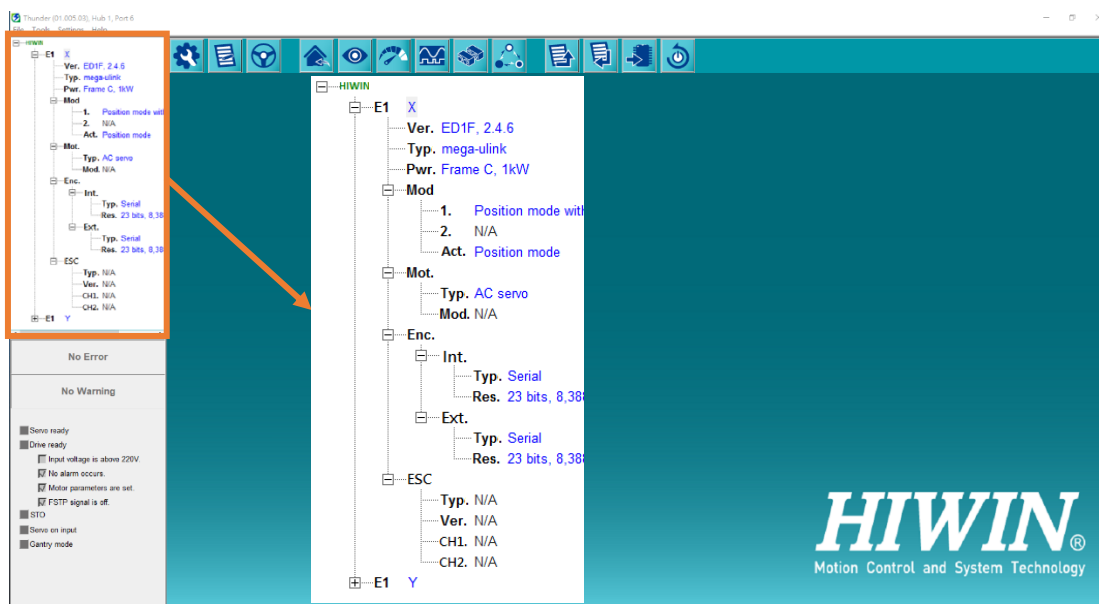

Figure 3.2.3.2.1

2. Click **Y axis** to switch to Y axis.

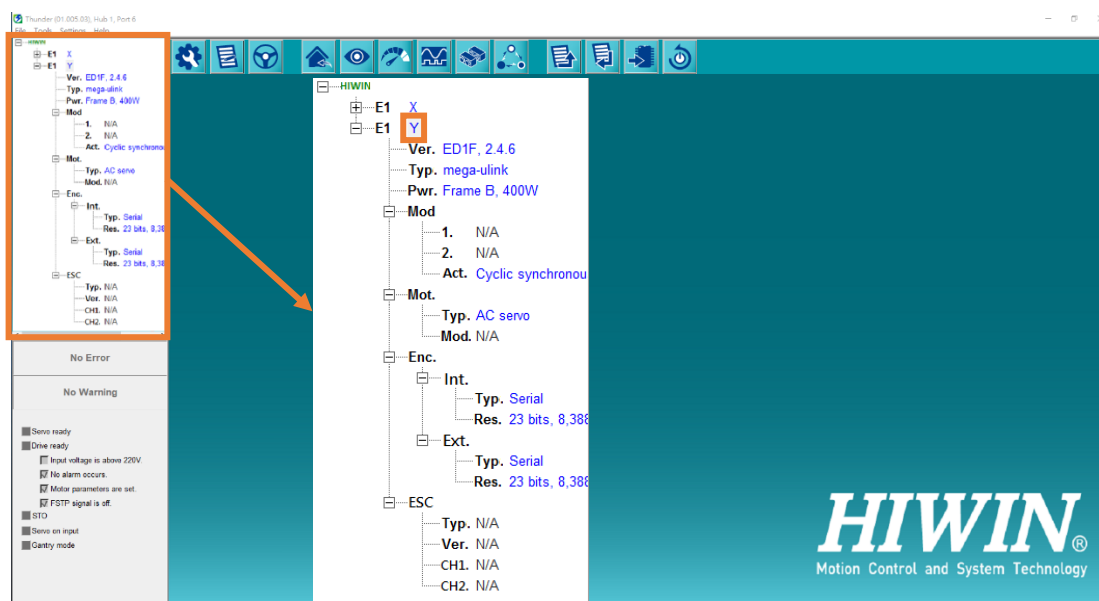

Figure 3.2.3.2.2

3.2.3.3 Modify axis name

Follow the procedure below to modify axis name. Here takes modifying Y axis to Z axis as an example.

1. Right-click **Y axis**.

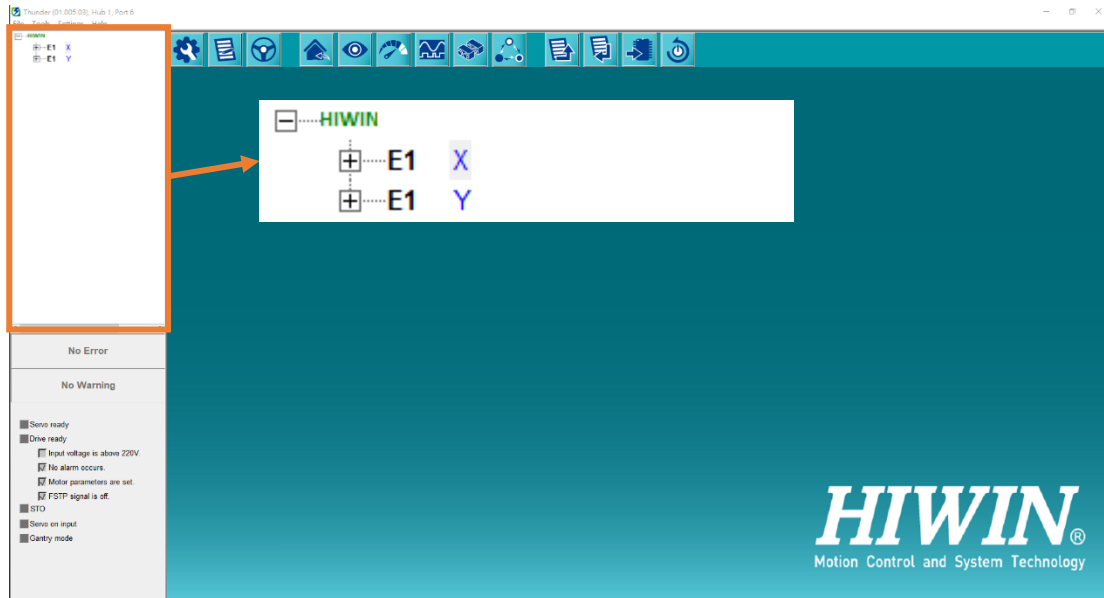

Figure 3.2.3.3.1

2. Select **Rename** to modify axis name.

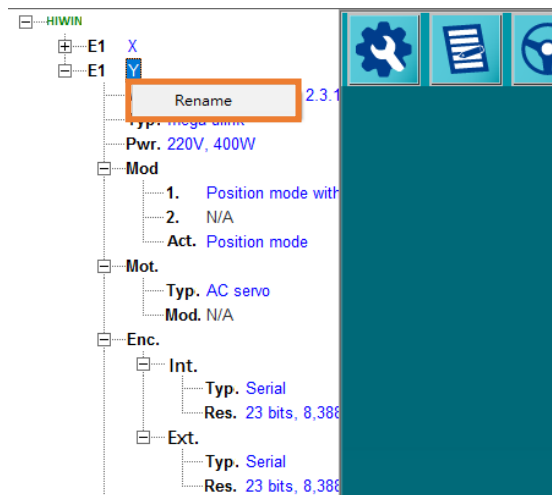

Figure 3.2.3.3.2

3. After entering new axis name **Z**, press Enter key on the keyboard to complete the modification.

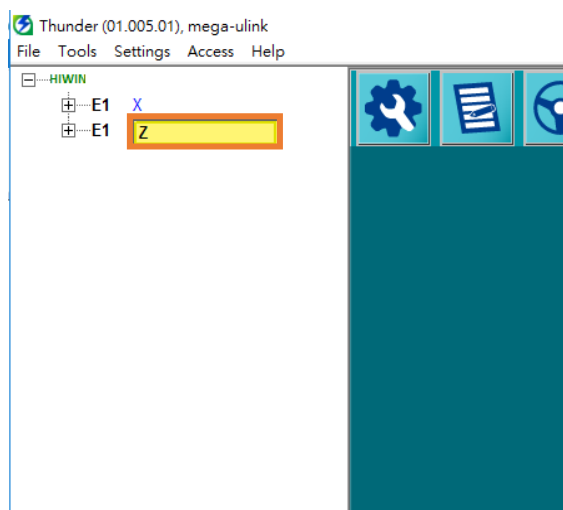

Figure 3.2.3.3.3

3.2.4 Off-line mode

Users can load servo drive parameters file (*.prm) on off-line mode to observe all parameters. Before using the function, ensure the servo drive parameters file (*.prm) to be observed has been saved as a file. Refer to section 4.4.3 for the details about loading servo drive parameters file (*.prm).



Important

Off-line mode only supports parameters viewing; it does not support parameters modifying. Therefore, it will be ineffective if users modify parameters on off-line mode.

Follow the procedure below to enter off-line mode.

1. Select **Off-line (View only)** in Config. interface.

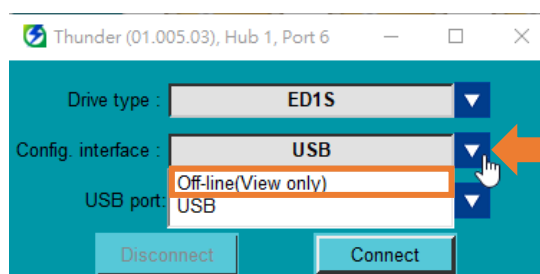

Figure 3.2.4.1

2. Click **Connect**.

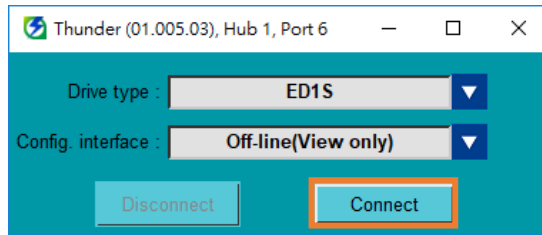

Figure 3.2.4.2

3. Click “Load parameters from file to drive” icon in the toolbar to open the servo drive parameters file (*.prm) to be observed.

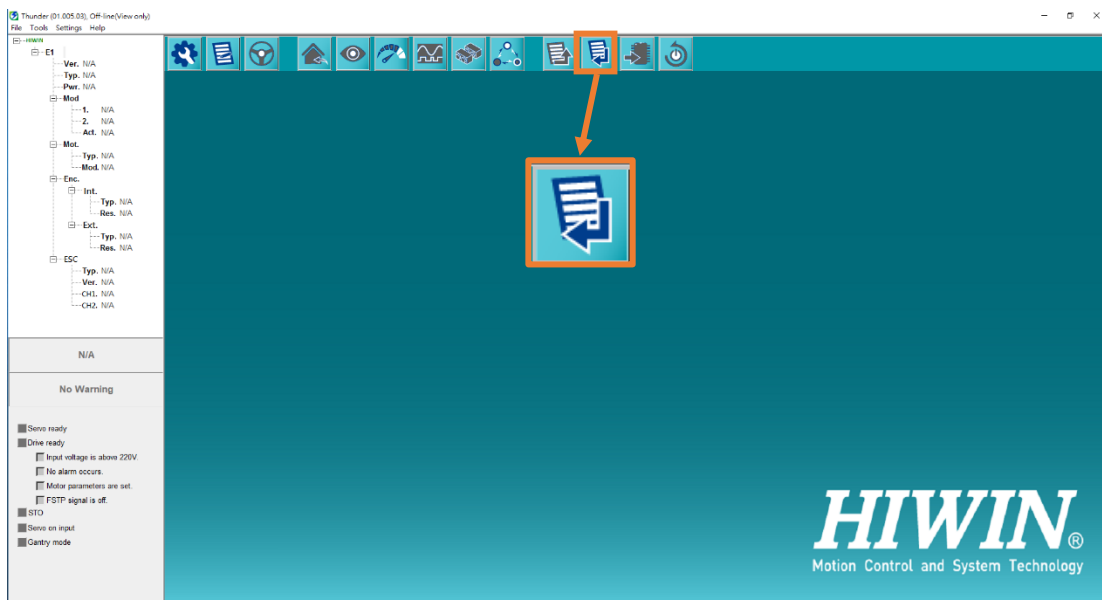

Figure 3.2.4.3

4. Click “Open Configuration Wizard” icon in the toolbar to open “Configuration Wizard” window. Refer to section 4.3 for the details of Configuration Wizard.

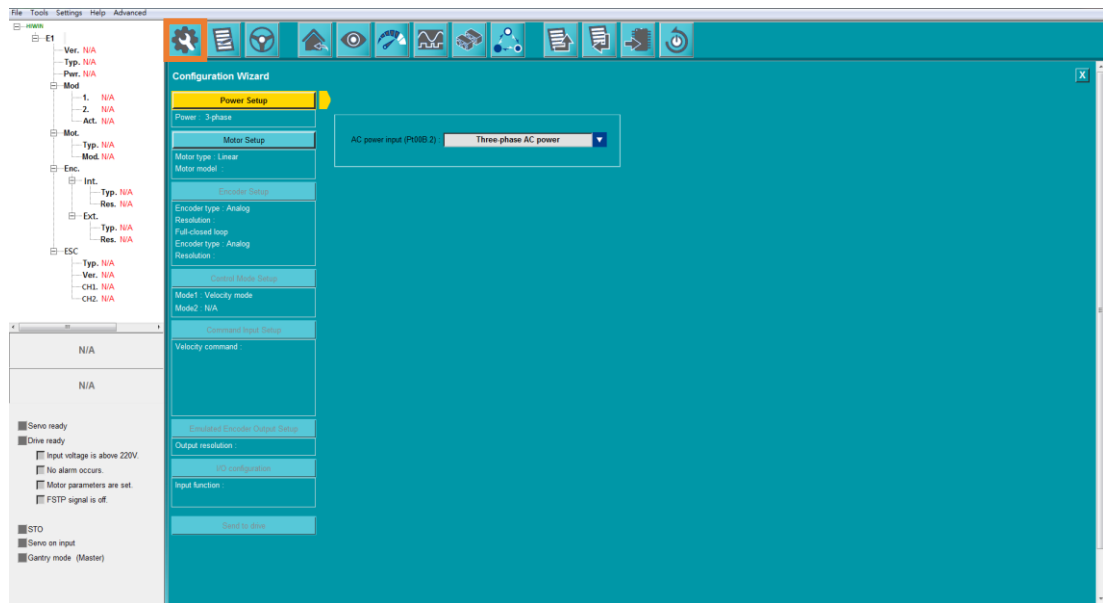

Figure 3.2.4.4

5. Click “Open Parameters Setup” icon in the toolbar to open “Parameters Setup” window. Refer to section 4.4 for the details of Parameters Setup.

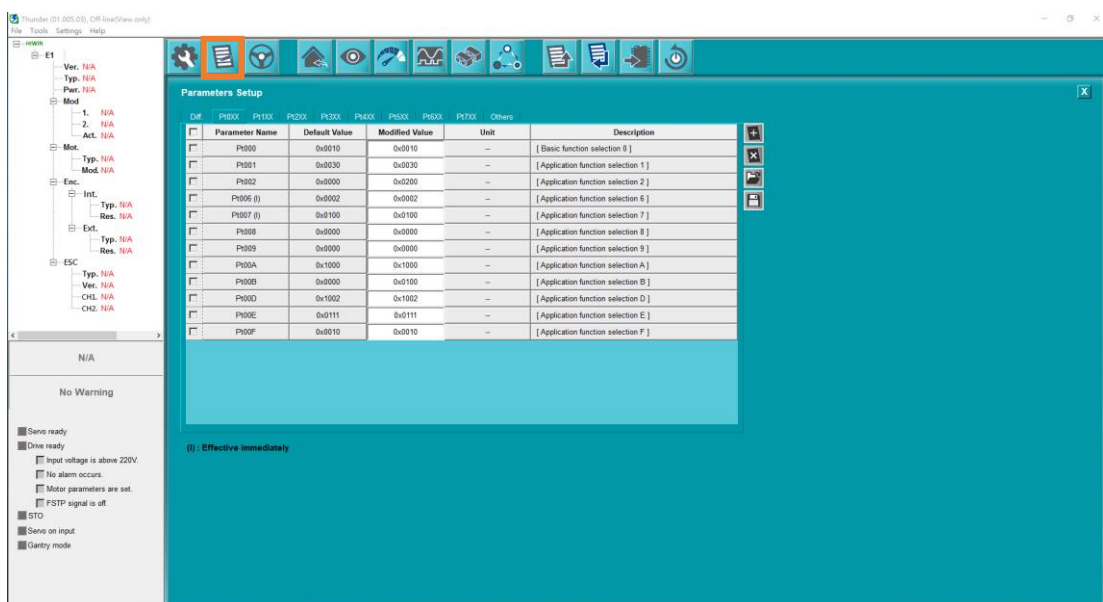

Figure 3.2.4.5

3.3 Mastership switching

Users can switch the mastership between host controller and Thunder. Before performing mastership switching, ensure the servo drive is Fieldbus type.

Table 3.3.1

Item	Reference
from Controller to Thunder	section 3.3.1
from Thunder to Controller	section 3.3.2



Important

- (1) Only Fieldbus servo drive supports mastership switching; standard servo drive does not support this function.
- (2) When Thunder holds the mastership, the controller will show “Off-line” and cannot connect to servo drive. When Controller holds the mastership, Thunder only has part of the monitoring functions and any parameter change is ineffective. To modify parameters, switch the mastership to Thunder.
- (3) If Fieldbus servo drive is power cycled, Controller automatically holds the mastership.

3.3.1 From Controller to Thunder

Follow the procedure below to switch the mastership from Controller to Thunder.

1. Select **Access** in the menu bar.

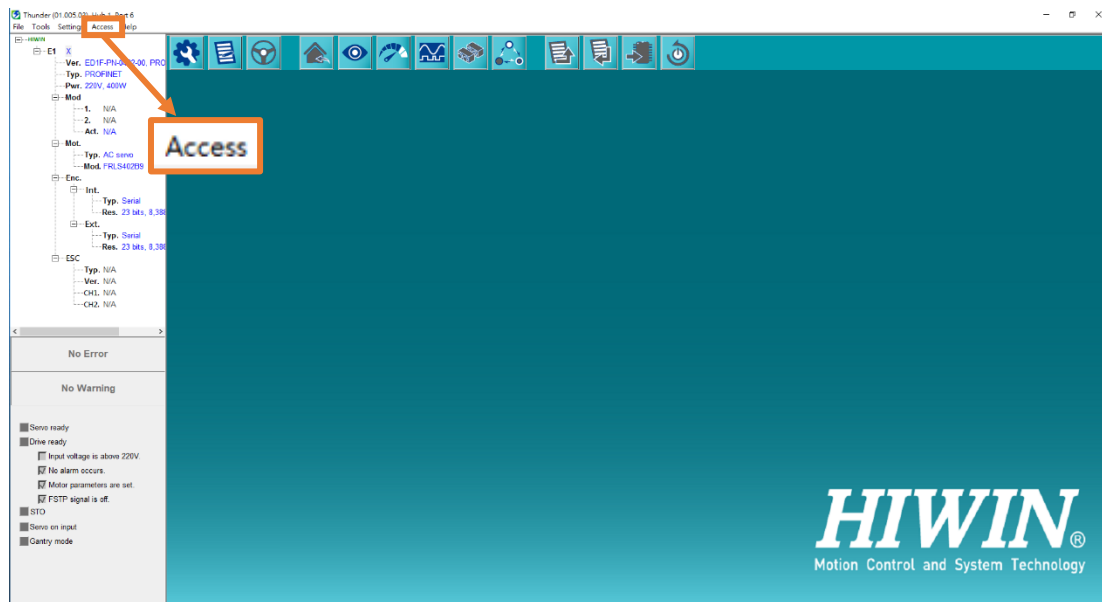

Figure 3.3.1.1

2. Select **Thunder**.

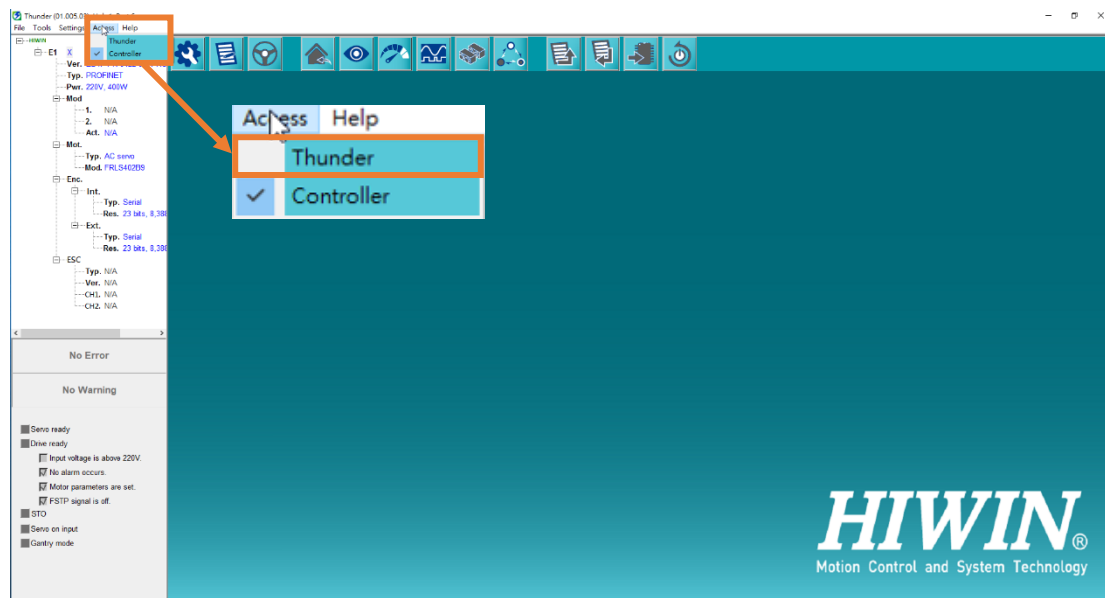

Figure 3.3.1.2

3.3.2 From Thunder to Controller

Follow the procedure below to switch the mastership from Thunder to Controller.

1. Select **Access** in the menu bar.

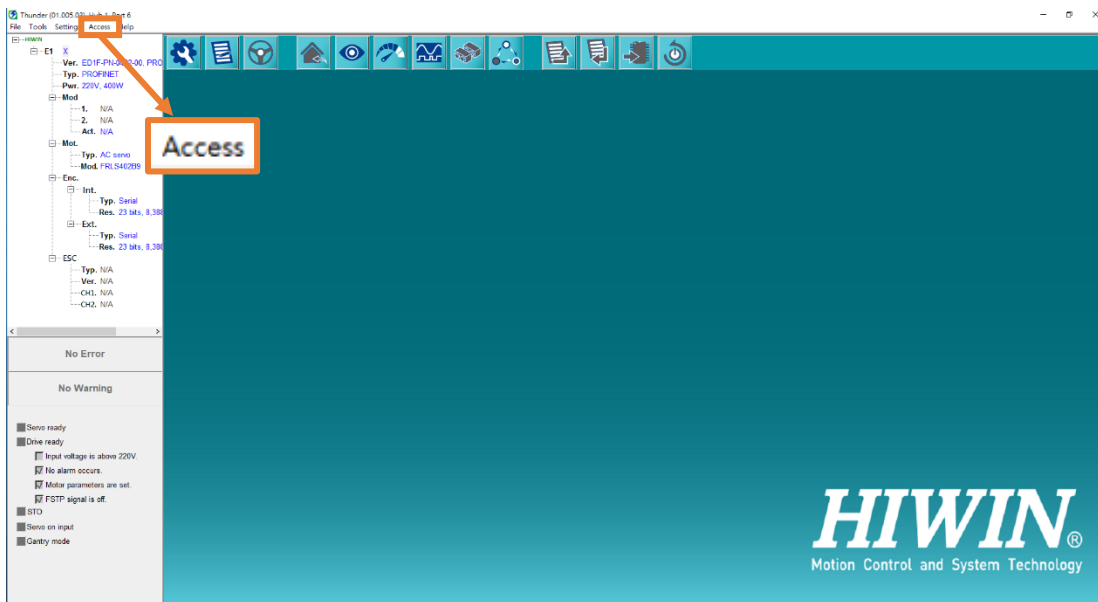

Figure 3.3.2.1

2. Select **Controller**.

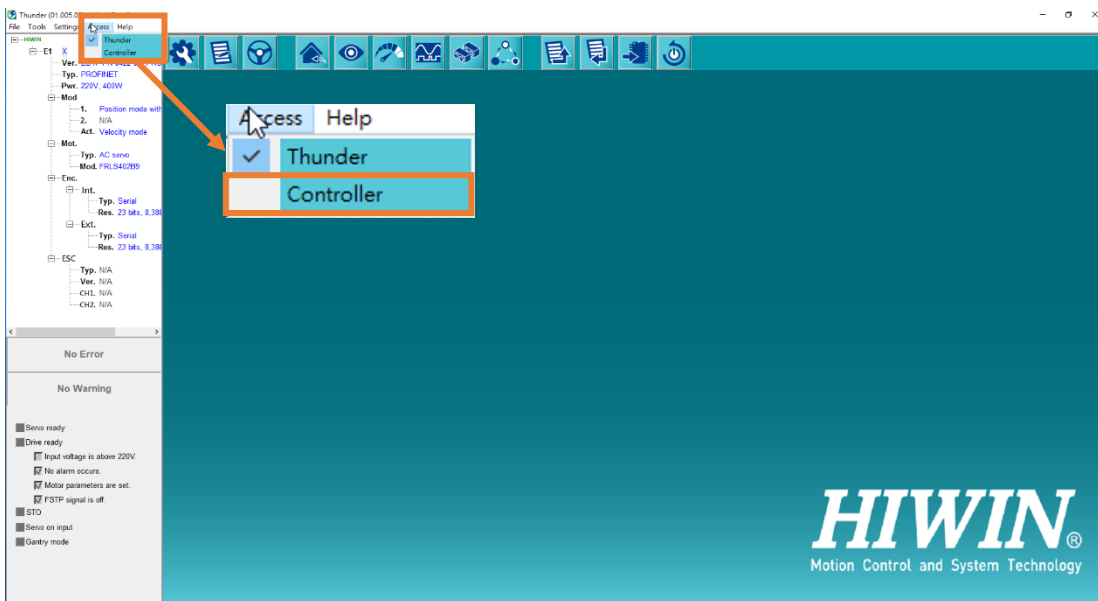

Figure 3.3.2.2

3.4 Update firmware

Users can update servo drive's firmware via Thunder. Here takes version 2.4.6 as an example.



Information

If version of firmware and Thunder are not compatible, the following window will show up. After clicking **OK**, use the Thunder version shown in the message.

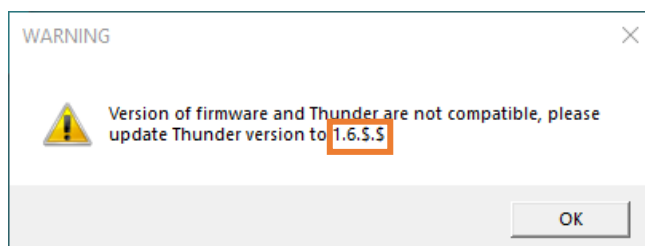

Figure 3.4.1

Follow the procedure below to complete firmware updating.

1. Select **Tools** in the menu bar and click **Update firmware** to open “Update firmware” window.

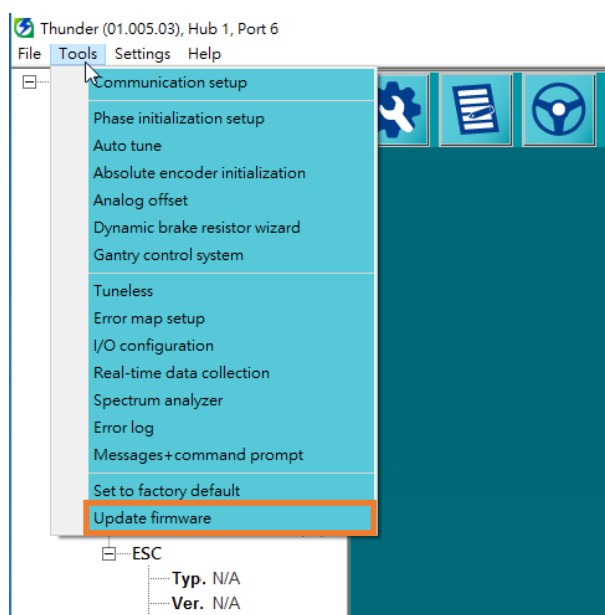

Figure 3.4.2

2. After selecting servo drive's firmware version, click **Download** and wait until the firmware updating procedure is done.

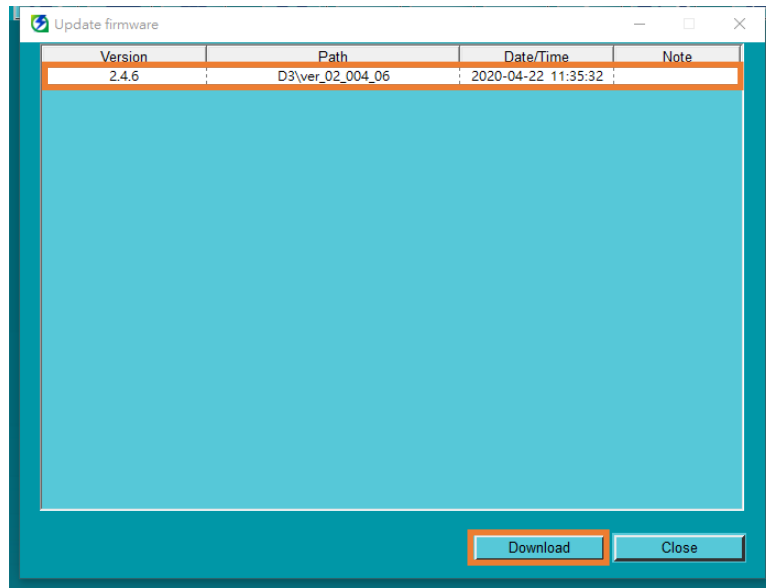

Figure 3.4.3

3. Ensure "Note" column shows **Connecting**.

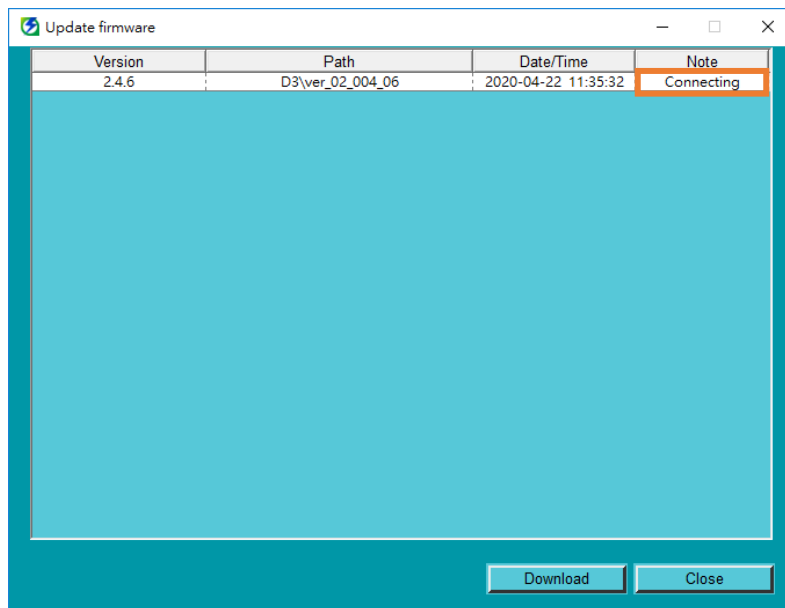

Figure 3.4.4

4. Servo Drive Configuration

4.	Servo Drive Configuration	4-1
4.1	Brief introduction	4-3
4.2	Pre-configuration function	4-4
4.3	Configuration Wizard	4-6
4.3.1	Brief introduction	4-6
4.3.2	Power Setup	4-7
4.3.3	Motor Setup	4-9
4.3.3.1	Edit motor parameters	4-10
4.3.3.2	Save / Load motor parameters file (*.mot)	4-12
4.3.4	Encoder Setup	4-14
4.3.4.1	Edit encoder parameters	4-15
4.3.4.2	Save / Load encoder parameters file (*.enc)	4-20
4.3.5	Control Mode Setup	4-22
4.3.6	Command Input Setup	4-24
4.3.6.1	Velocity mode	4-24
4.3.6.2	Position mode	4-26
4.3.6.3	Electronic gear ratio setting	4-32
4.3.6.4	Torque mode	4-38
4.3.6.5	Internal velocity mode	4-39
4.3.6.6	Internal position mode	4-40
4.3.7	Emulated Encoder Output Setup	4-42
4.3.8	I/O configuration	4-44
4.3.9	Send to drive	4-45
4.4	Parameters Setup	4-47
4.4.1	Brief introduction	4-47
4.4.2	Edit parameters	4-48
4.4.2.1	Parameters comparison	4-49
4.4.2.2	Set Pt parameters	4-50
4.4.2.3	User-defined parameters	4-52
4.4.2.4	Send to drive	4-57
4.4.3	Create a servo drive parameters file	4-58
4.4.3.1	Brief introduction	4-58
4.4.3.2	Save servo drive parameters file (*.prm)	4-58
4.4.3.3	Load servo drive parameters file (*.prm)	4-60
4.4.4	Send the parameters to servo drive	4-63
4.4.5	Reset drive	4-64

4.4.6	Set to factory default	4-66
4.4.6.1	Brief introduction	4-66
4.4.6.2	Set to factory default	4-67
4.4.6.3	Clear error map table	4-68
4.4.6.4	Disable multi-motion function	4-69
4.4.6.5	Clear PDL	4-70
4.5	I/O configuration	4-71
4.5.1	Brief introduction	4-71
4.5.2	Configuration of digital input signals	4-72
4.5.3	Configuration of digital output signals	4-75
4.5.4	Check configuration of I/O signals	4-78
4.6	Phase initialization setup	4-79
4.6.1	Brief introduction	4-79
4.6.2	Direction test	4-81
4.6.2.1	Parameters setup for direction test	4-81
4.6.2.2	Start direction test	4-84
4.6.3	Phase initialization function	4-88
4.6.3.1	SW method 1	4-89
4.6.3.2	STABS test/tune	4-90
4.6.3.3	Digital hall	4-91
4.6.4	Start phase initialization	4-93

4.1 Brief introduction

All the basic setting procedures of using servo drive are introduced in this chapter. For the detailed descriptions of servo drive, please refer to “E1 Series Servo Drive User Manual”.

Pre-configuration function

Before servo drive configuration, users can select servo motor type, encoder type and the usage of ESC.

Configuration Wizard

Through step-by-step interface, users can easily set and view servo drive's important parameters. Configuration Wizard makes the process of setting necessary parameters become very easy, and it is also the procedure must be completed during the process of operating servo drive.

Parameters Setup

Based on the classified servo drive Pt parameters list, users can set or compare the Pt parameters different from factory default values. Besides, users can create, edit, save and load personalized parameters list.

I/O configuration

Users can configure servo drive's digital input signals and digital output signals.

Phase initialization setup

Users can perform servo motor's electrical angle positioning with step-by-step phase initialization setup.

4.2 Pre-configuration function

Before servo drive configuration, users can select servo motor type, encoder type and the usage of ESC.

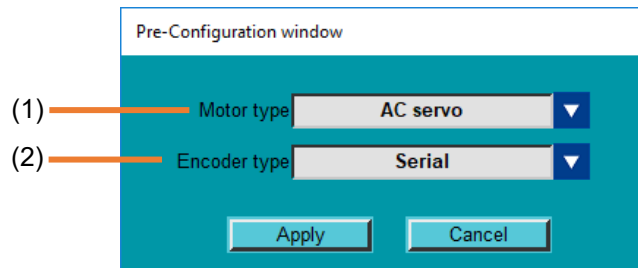

Figure 4.2.1

Table 4.2.1

No.	Item	Description
(1)	Menu of servo motor	Select servo motor type: Linear, Torque / direct drive motor or AC servo
(2)	Menu of encoder	Select encoder format: Analog + Smart cube, Digital, Digital + Smart cube, Serial or Serial + Smart cube



If servo drive configuration is done, this window will not show up.

Information

Follow the procedure below to complete pre-configuration function setting.

1. Select servo motor type.

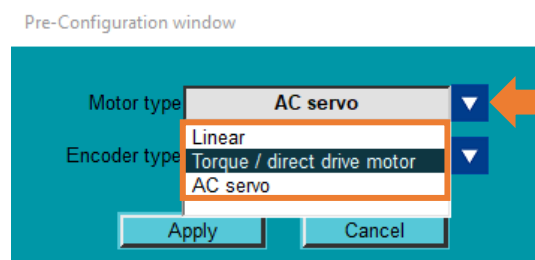

Figure 4.2.2

2. Select encoder format. If there is an ESC connected, select the encoder format + Smart cube.

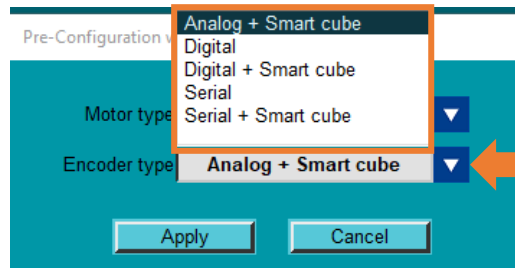

Figure 4.2.3

3. After the selection, click **Apply** to complete pre-configuration function setting. At this time, servo drive will be power cycled. After that, go to **Configuration Wizard** to continue setting servo drive.

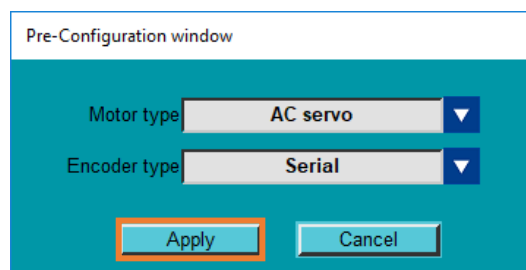

Figure 4.2.4



Information

- (1) If users do not want to use pre-configuration function, click **Cancel** and directly go to **Configuration Wizard** to set servo drive.
- (2) Ensure all the selections are the same with the actual equipment.

4.3 Configuration Wizard

4.3.1 Brief introduction

Configuration Wizard leads users to set parameters with step-by-step interface. Power setup, motor setup, encoder setup, control mode setup, mechanical structure selection, command input setup, emulated encoder output setup and I/O configuration are all important parameters settings for servo drive. When users complete all the steps in Configuration Wizard, these parameters will be properly set.

Configuration Wizard has the following functions:

- ◆ Even if it is the first time for users to use servo drive, the parameters setting process is very easy and fast.
- ◆ On position control mode, users can easily get the automatically calculated electronic gear ratio by selecting mechanical structure and entering control unit.

The procedure of Configuration Wizard is given in Table 4.3.1.1.

Table 4.3.1.1

Step	Description	Reference
1	Power Setup Set the related parameter for power.	section Fehler! Verweisquelle konnte nicht gefunden werden.
2	Motor Setup Select motor type and the related parameters setting.	section 4.3.3
3	Encoder Setup Select encoder format and the related parameters setting.	section 4.3.4
4	Control Mode Setup Select control mode.	section 4.3.5
5	Command Input Setup Set the corresponding command input parameters based on different control mode setting.	section 4.3.6
6	Emulated Encoder Output Setup Set emulated encoder output resolution.	section 4.3.7
7	I/O configuration Set input and output signals.	section 4.3.8
8	Send to drive Check parameters and save them to servo drive.	section 0

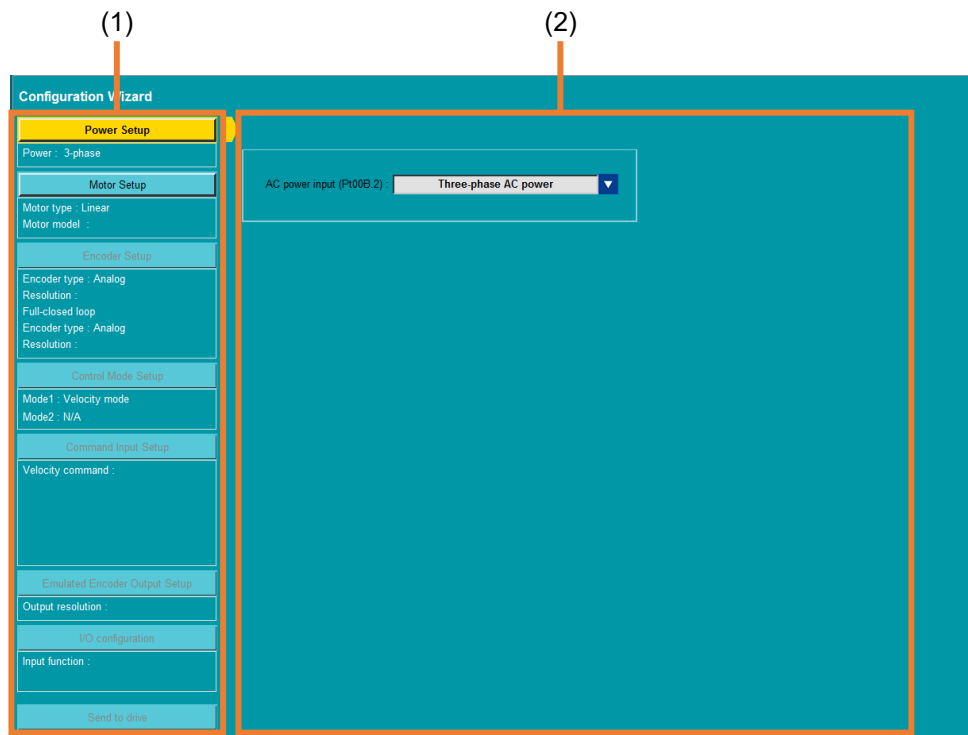

Figure 4.3.1.1

Table 4.3.1.1

No.	Item	Description
(1)	Setting steps switching	<ol style="list-style-type: none"> 1. This area displays all the steps and the current setting values of the parameters. 2. Click the buttons in this area to switch to the next step or return to the previous step.
(2)	Parameters setting page	This area will display the corresponding parameters setting page based on the current step.

4.3.2 Power Setup

Set the desired power. The procedure of power setup is as below.



Important

For **2 kW servo drive or above**, AC power input will be automatically set as **Three-phase AC power**. Users cannot modify the setting.

1. Click "Open Configuration Wizard" icon in the toolbar to open "Configuration Wizard" window.

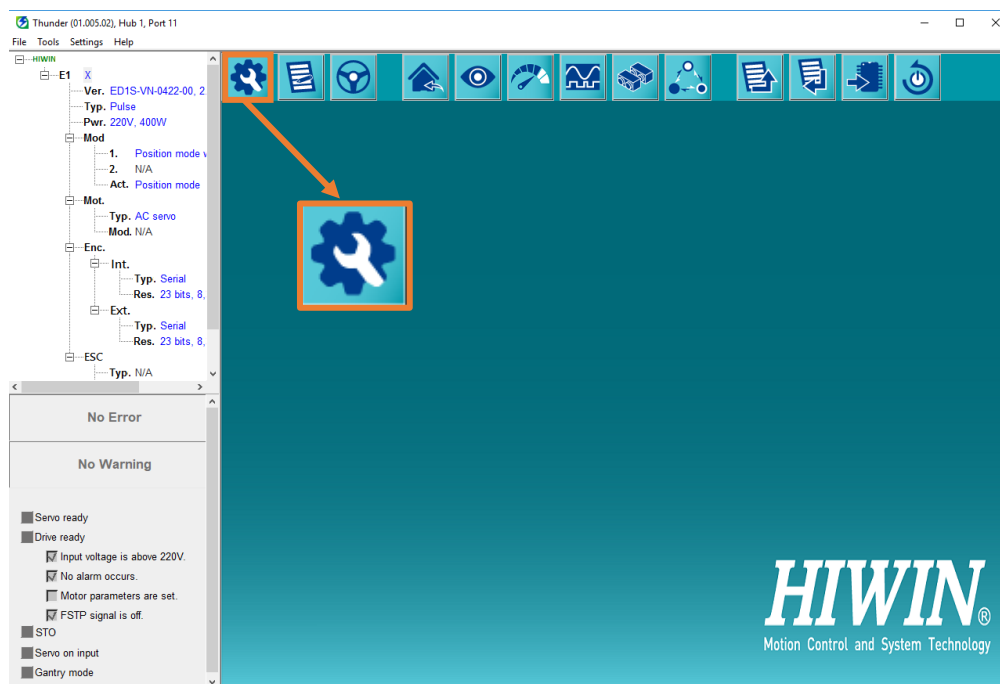

Figure 4.3.2.1

2. Select the desired power, and click **Motor Setup** to continue the setting of the next step.

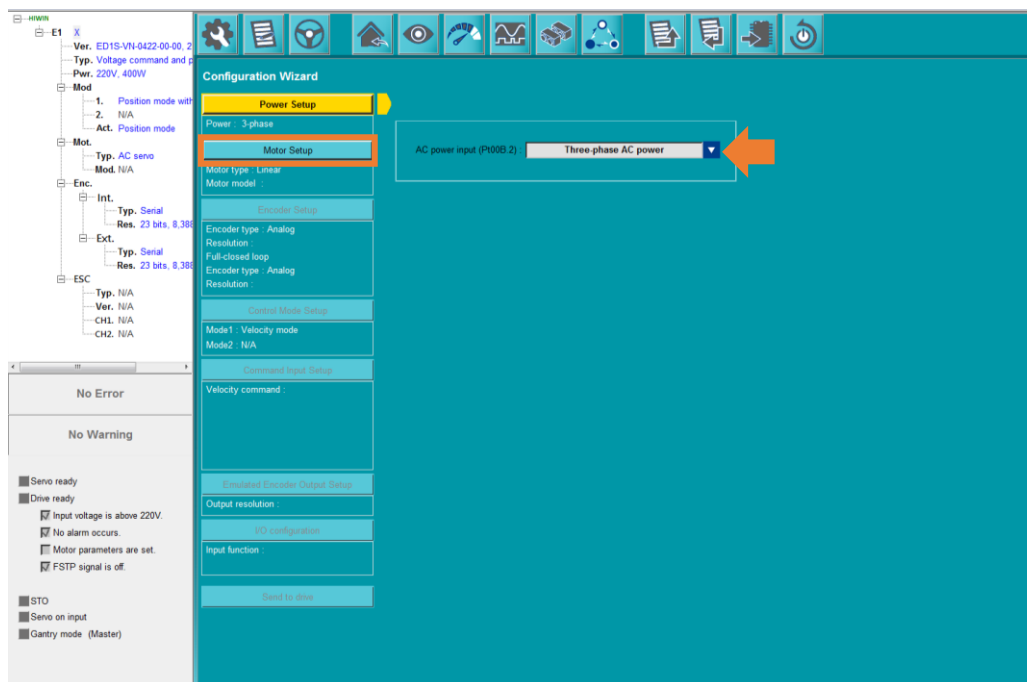

Figure 4.3.2.2

4.3.3 Motor Setup

Select the correct model based on the motor type. Motor parameters will be automatically filled in after the selection. This page also provides the following functions:

- ◆ If the motor is not made by HIWIN, users must fill in the corresponding motor parameters.
- ◆ Users can save motor parameters as a file (*.mot).

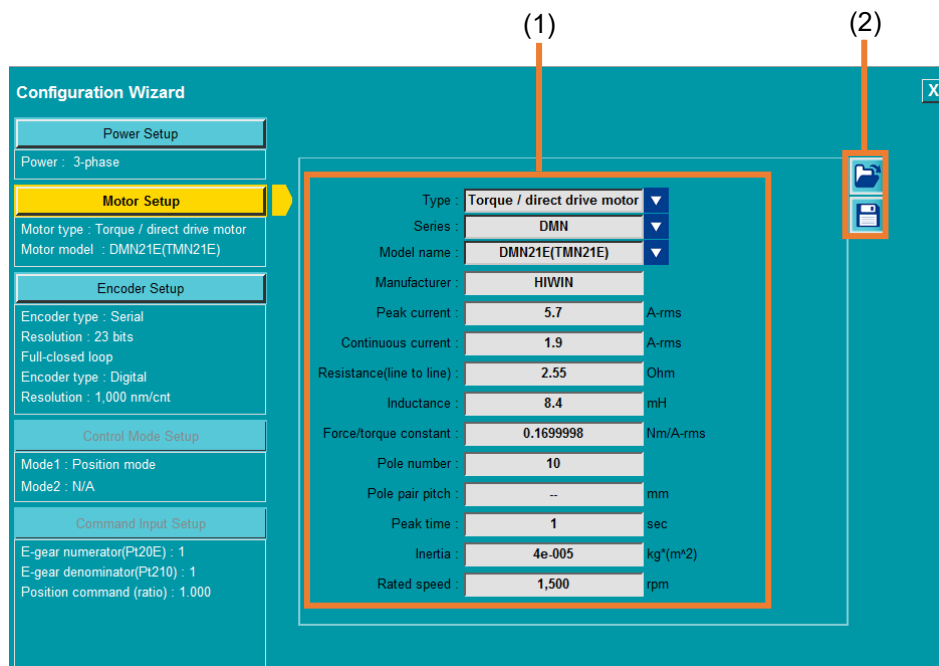

Figure 4.3.3.1

Table 4.3.3.1

No.	Item	Description	Reference
(1)	Edit motor parameters	Select motor model (motor parameters will be automatically filled in) or select Customized (users can fill in the desired motor parameters).	section 4.3.3.1
(2)	Save / Load motor parameters file	Create a motor parameters file (*.mot) for further use.	section 4.3.3.2

4.3.3.1 Edit motor parameters

The procedure of motor setup is as below.

1. Select motor type. Here takes Torque / direct drive motor as an example.

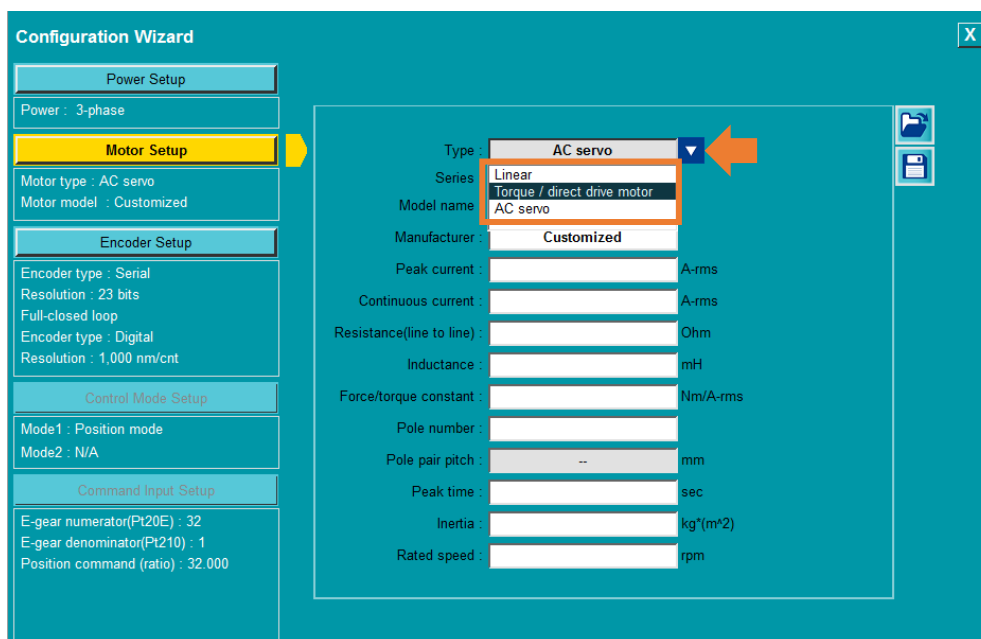

Figure 4.3.3.1.1

2. Select motor series.

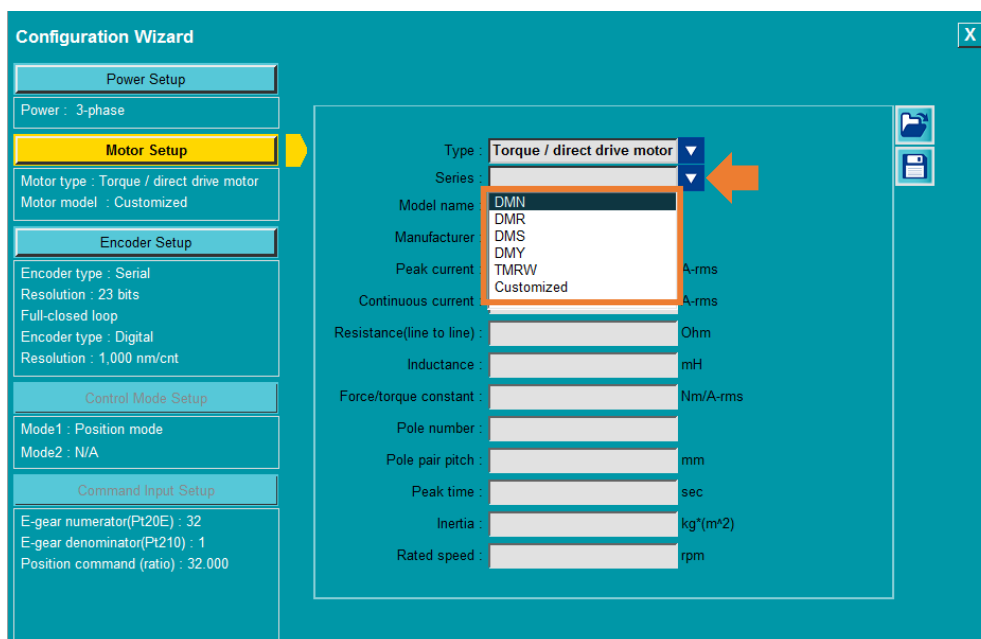

Figure 4.3.3.1.2

3. Select motor model.

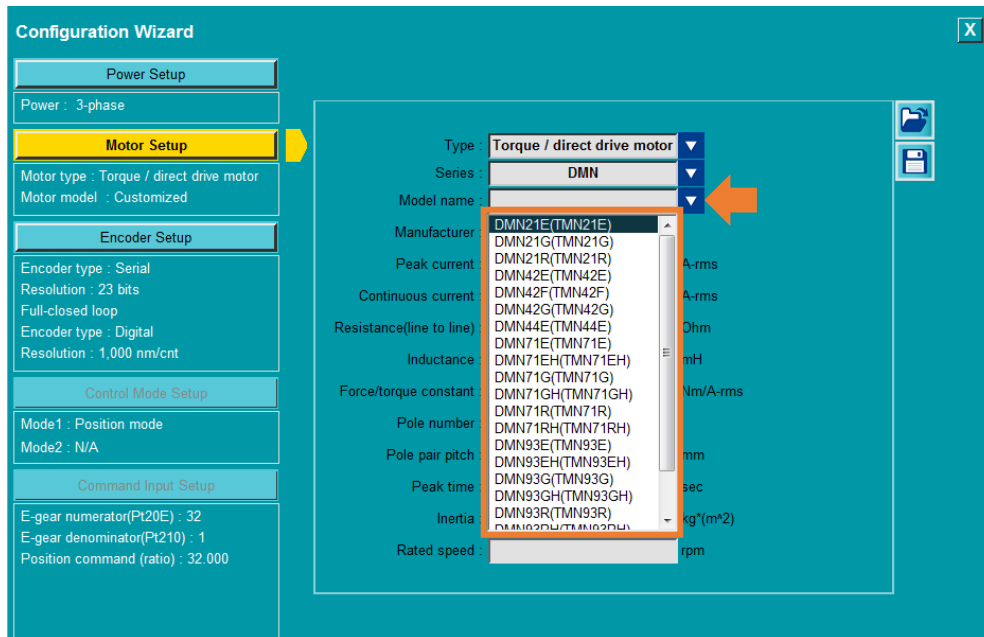

Figure 4.3.3.1.3

4. At this time, motor parameters will be automatically filled in.



Figure 4.3.3.1.4



Information

If the motor is not made by HIWIN, select **Customized** in “Series” column after selecting motor type. Then, fill in the necessary parameters based on the motor specification.

Type :	Torque / direct drive motor	
Series :	Customized	
Model name :	Customized	
Manufacturer :		
Peak current :		A-rms
Continuous current :		A-rms
Resistance(line to line) :		Ohm
Inductance :		mH
Force/torque constant :		Nm/A-rms
Pole number :		
Pole pair pitch :	--	mm
Peak time :		sec
Inertia :		kg*(m ²)
Rated speed :		rpm

Figure 4.3.3.1.5

4.3.3.2 Save / Load motor parameters file (*.mot)

■ Save motor parameters file (*.mot)

1. Click “Save parameters as a file” icon .

Type :	Torque / direct drive motor	
Series :	Customized	
Model name :	MOT	
Manufacturer :	MANU	
Peak current :	10.2	A-rms
Continuous current :	3.4	A-rms
Resistance(line to line) :	4.3	Ohm
Inductance :	23.2	mH
Force/torque constant :	4.1	Nm/A-rms
Pole number :	22	
Pole pair pitch :	--	mm
Peak time :	1	sec
Inertia :	0.012	kg*(m ²)
Rated speed :	500	rpm

Figure 4.3.3.2.1

2. Key in file name of motor parameters file (*.mot), select archive path, and click **Save**.

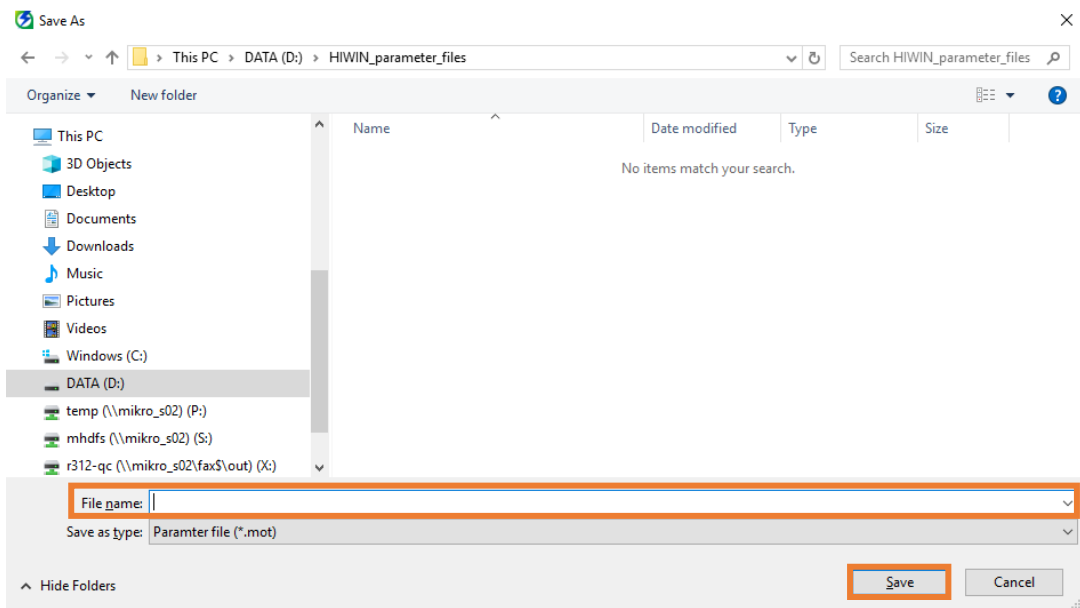

Figure 4.3.3.2.2

■ Load motor parameters file (*.mot)

1. Click “Load parameters from file” icon .

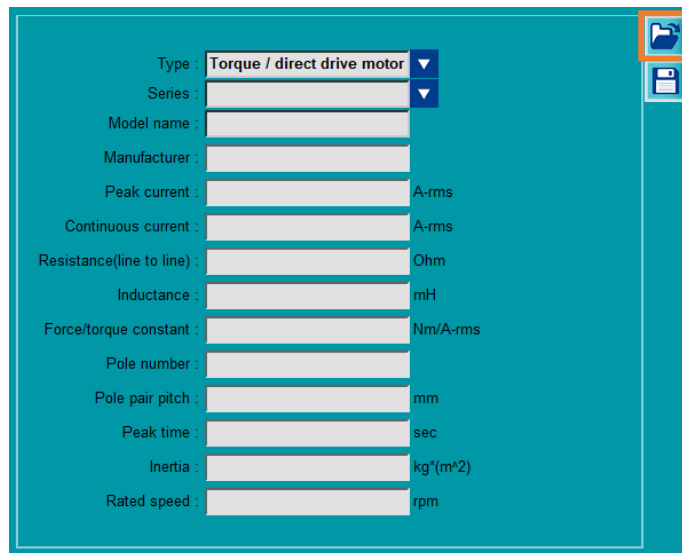

Figure 4.3.3.2.3

2. Select motor parameters file (*.mot), and click **Open**.

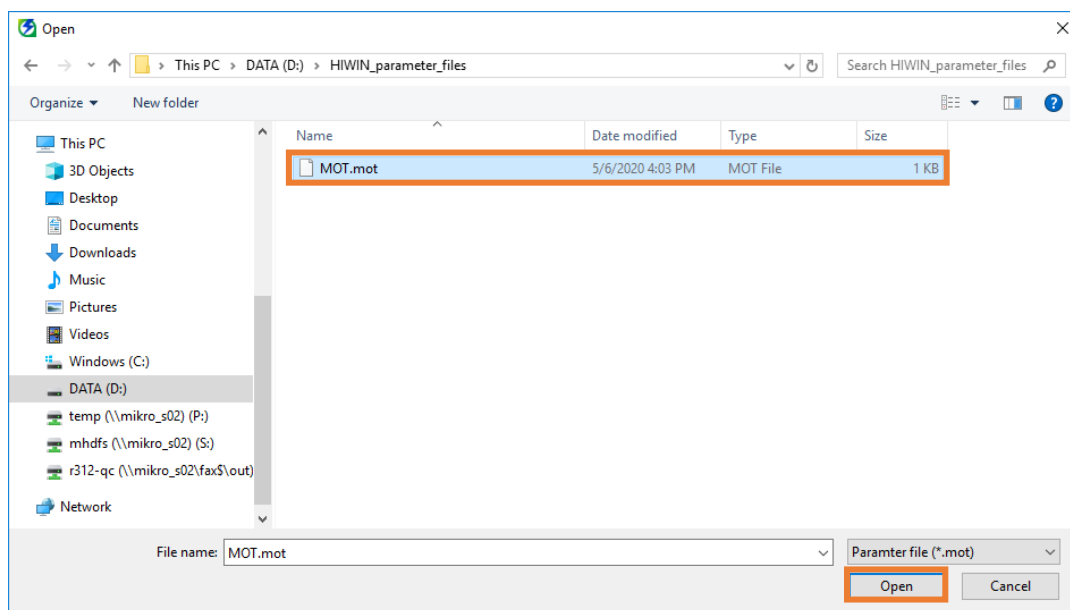

Figure 4.3.3.2.4

4.3.4 Encoder Setup

Select the correct format based on the encoder type. Encoder parameters will be automatically filled in after the selection. This page also provides the following functions:

- ◆ If there is no suitable encoder resolution, users can fill in the desired encoder parameters.
- ◆ Users can save encoder parameters as a file (*.enc).

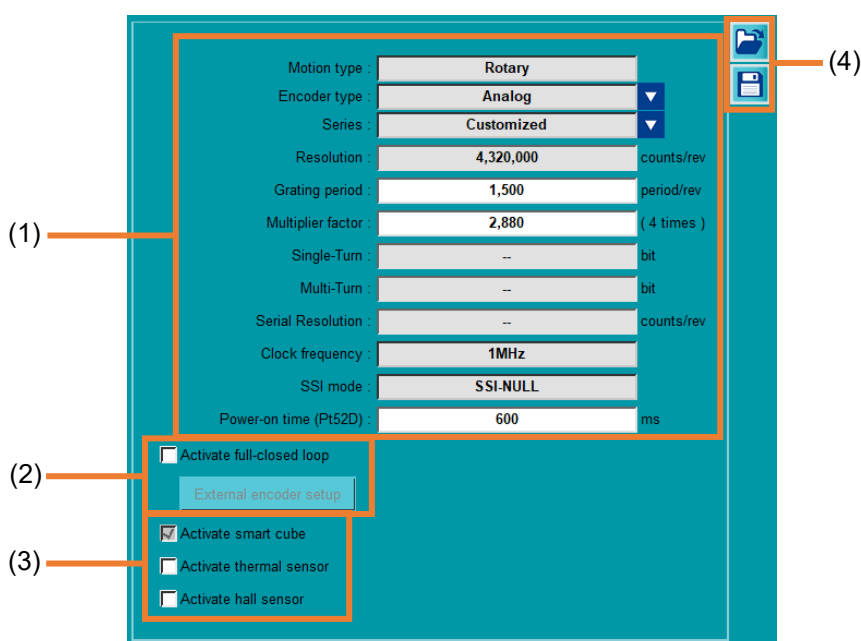

Figure 4.3.4.1

Table 4.3.4.1

No.	Item	Description	Reference
(1)	Edit encoder parameters	Select encoder model (encoder parameters will be automatically filled in) or select Customized (users can fill in the desired encoder parameters).	section 4.3.4.1
(2)	Full-closed loop setting	To use full-closed loop, check Activate full-closed loop , and click External encoder setup to open “External encoder setting” window for parameters setting.	section 4.3.4.1
(3)	ESC function selection	If there is an ESC connected, check Activate smart cube , and decide whether to check the corresponding option of activating over temperature protection or hall sensor function. If Activate smart cube is not checked, over temperature protection and hall sensor function cannot be used.	section 4.3.4.1
(4)	Save / Load encoder parameters file	Create an encoder parameters (*.enc) file for further use.	section 4.3.4.2

4.3.4.1 Edit encoder parameters

Encoder parameters will be automatically filled in based on **Motor Setup**. The procedure of encoder setup is as below.

1. Click **Encoder Setup** to enter encoder setup page.

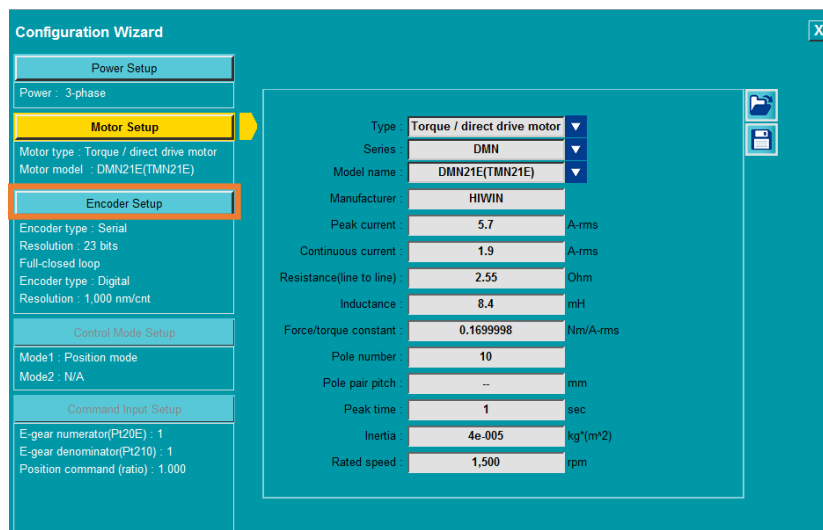

Figure 4.3.4.1.1

2. Select encoder type and series. At this time, encoder parameters will be automatically filled in.

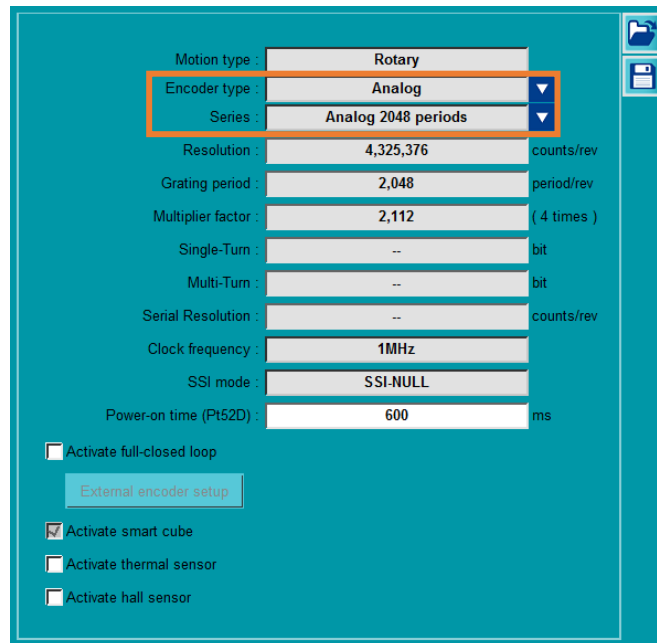

Figure 4.3.4.1.2



Information

- (1) Encoder type can be **Analog**, **Digital** or **Serial**. Currently, serial type encoder only supports BiSS-C and EnDat; SSI, NIKON and Hiperface are not supported yet.
- (2) Besides some encoder parameters with common resolution which match HIWIN motor, users can select **Customized** in “Series” column to key in the related parameters of other brand’s encoder. The corresponding parameter columns will be opened according to different encoder type. If the column displays “--”, there is no need to key in any value.

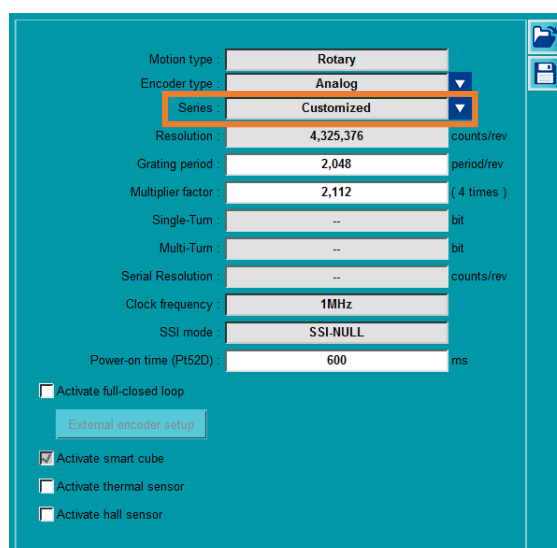

Figure 4.3.4.1.3

- (3) If **Analog** is selected in “Encoder type” column and **Customized** is selected in “Series” column, its maximum multiplier factor is 4096 times. (The value must be a multiple of 4.)

3. To use full-closed loop, check **Activate full-closed loop**, and click **External encoder setup** to open “External encoder setting” window for parameters setting. If there is no need to use full-closed loop, do not check **Activate full-closed loop**, and skip step 4.

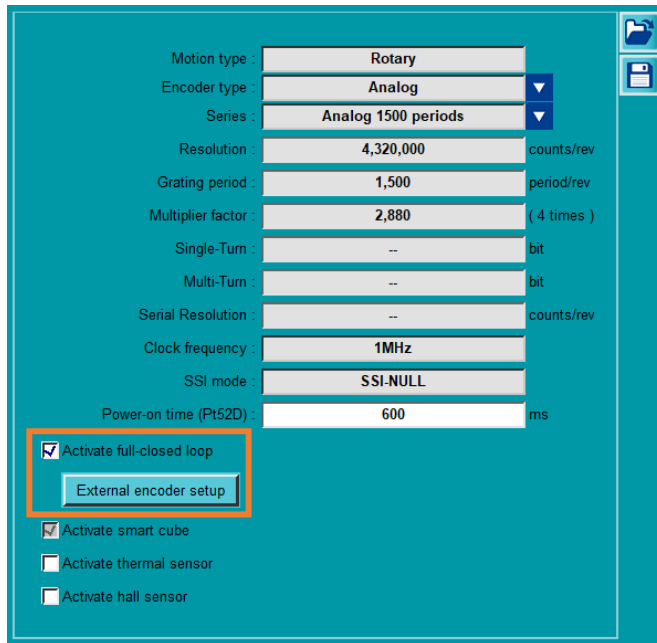

Figure 4.3.4.1.4



Important

After checking **Activate full-closed loop**, a reminder window will pop up. After reading the words and ensuring the direction of internal encoder is the same as that of external encoder, click **OK**. For the detailed descriptions of full-closed loop function, please refer to section 8.16 in “E1 Series Servo Drive User Manual”.

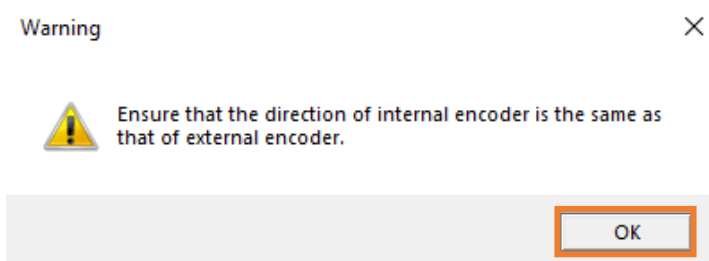

Figure 4.3.4.1.5

- After opening “External encoder setting” window, select external encoder type and series, and key in encoder parameters.

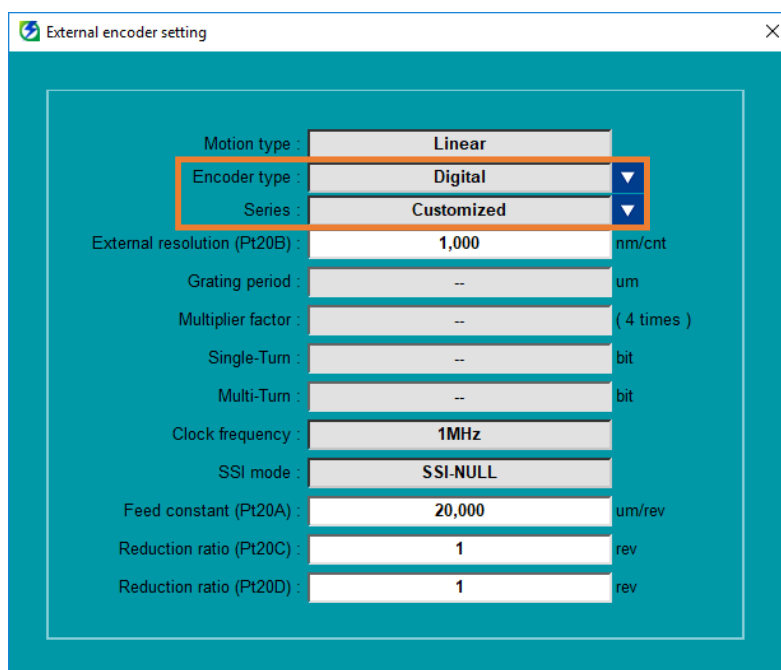

Figure 4.3.4.1.6



Information

Users can select **Customized** in “Series” column to key in the customized external encoder parameters.

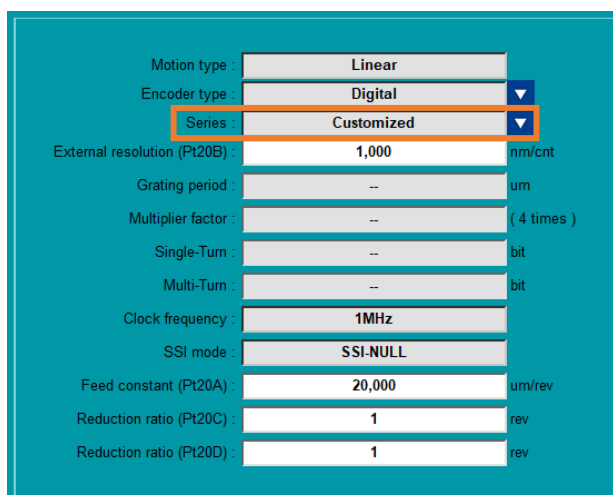

Figure 4.3.4.1.7

5. If there is an ESC connected, check **Activate smart cube**. To use the over temperature protection function after connecting ESC, check **Activate thermal sensor** and ensure the motor over temperature cable is certainly connected to thermal sensor (TS) of ESC.

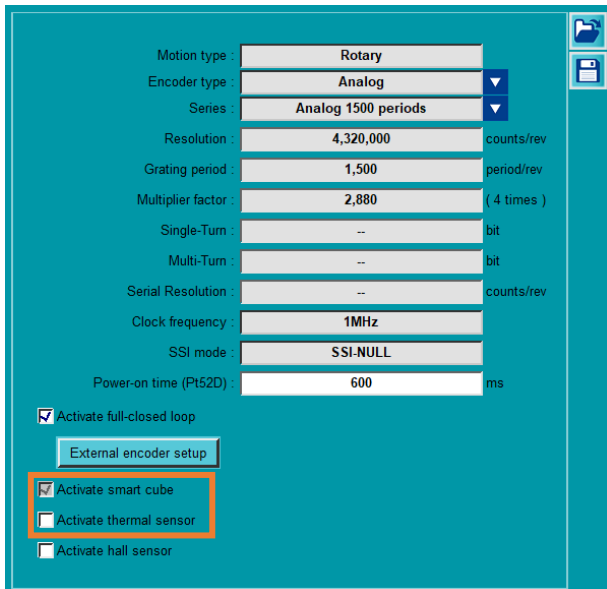

Figure 4.3.4.1.8

6. To use hall sensor, check **Activate hall sensor**.

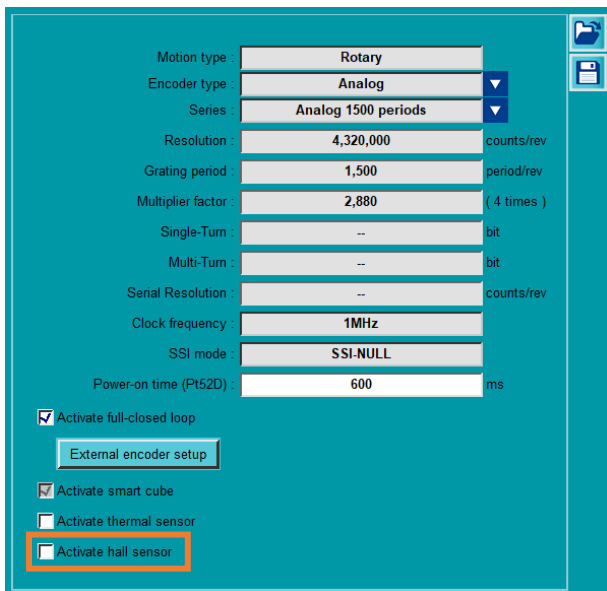

Figure 4.3.4.1.9



Information

Over temperature protection function and hall sensor function must be used with ESC.

4.3.4.2 Save / Load encoder parameters file (*.enc)

■ Save encoder parameters file (*.enc)

1. Click “Save parameters as a file” icon .

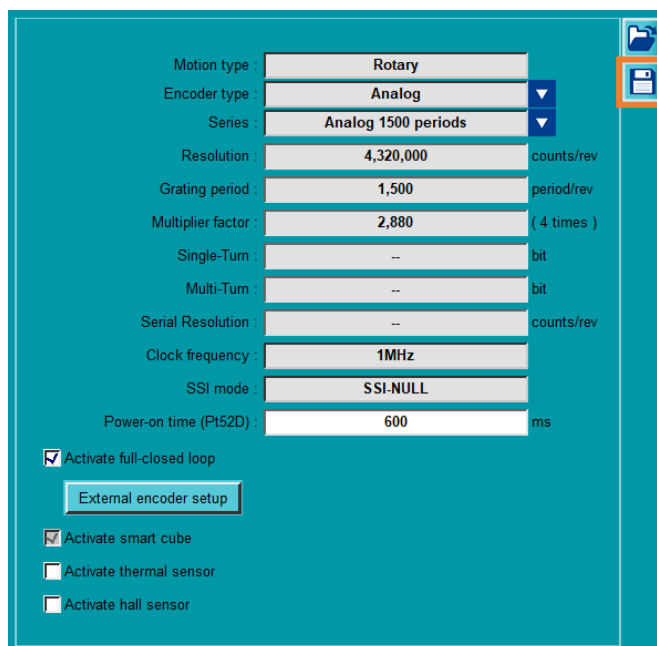

Figure 4.3.4.2.1

2. Key in file name of encoder parameters file (*.enc), select archive path, and click **Save**.

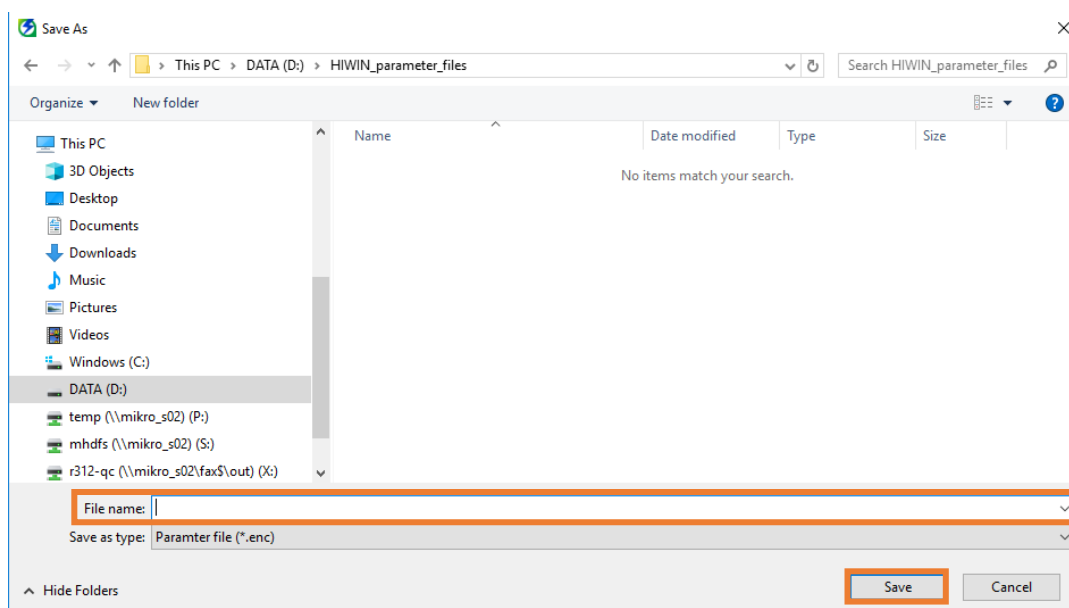

Figure 4.3.4.2.2

■ Load encoder parameters file (*.enc)

1. Click “Load parameters from file” icon .

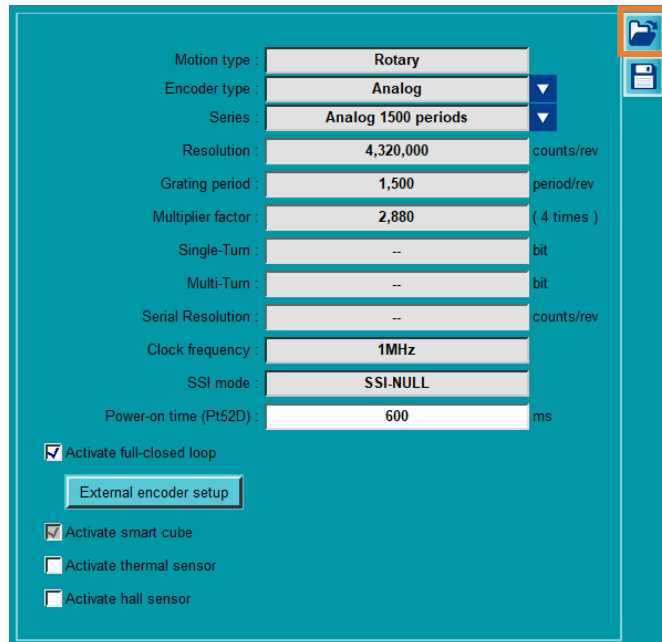

Figure 4.3.4.2.3

2. Select encoder parameters file (*.enc), and click **Open**.

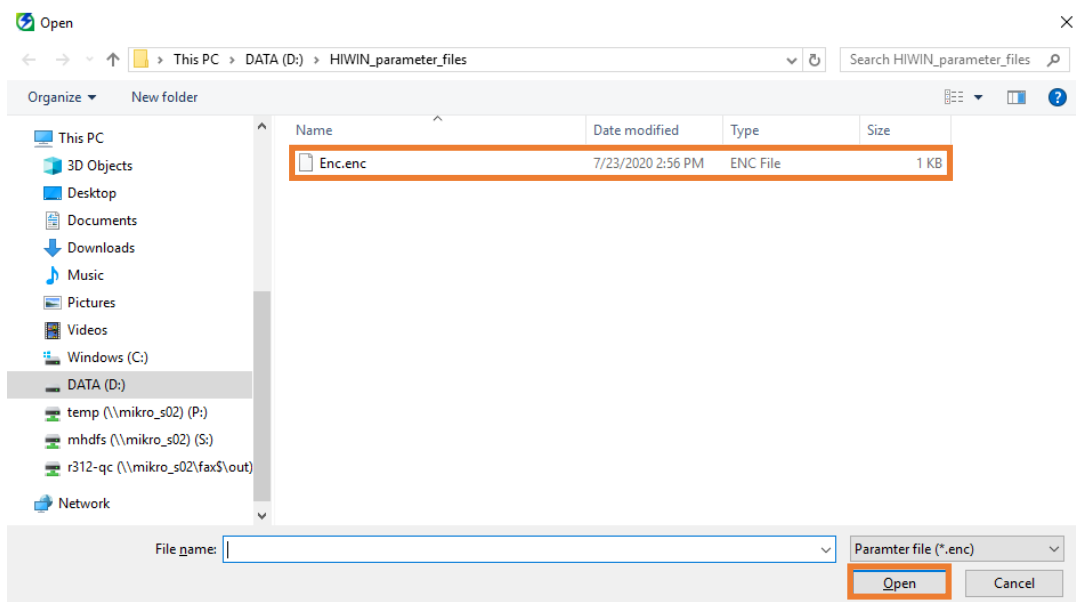

Figure 4.3.4.2.4

4.3.5 Control Mode Setup

Set the desired control mode. The procedure of control mode setup is as below.

1. Click **Control Mode Setup** to enter control mode setup page.

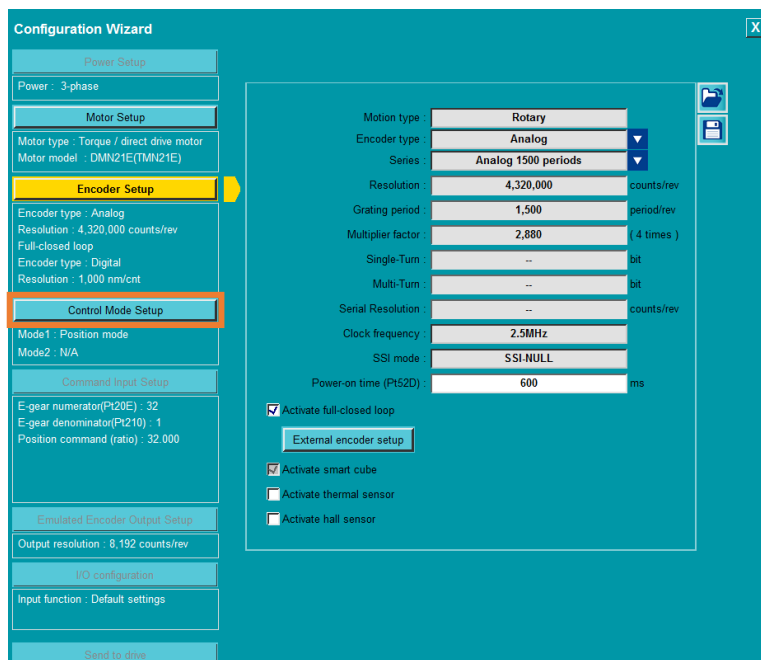

Figure 4.3.5.1

2. Open the menu to select control mode.

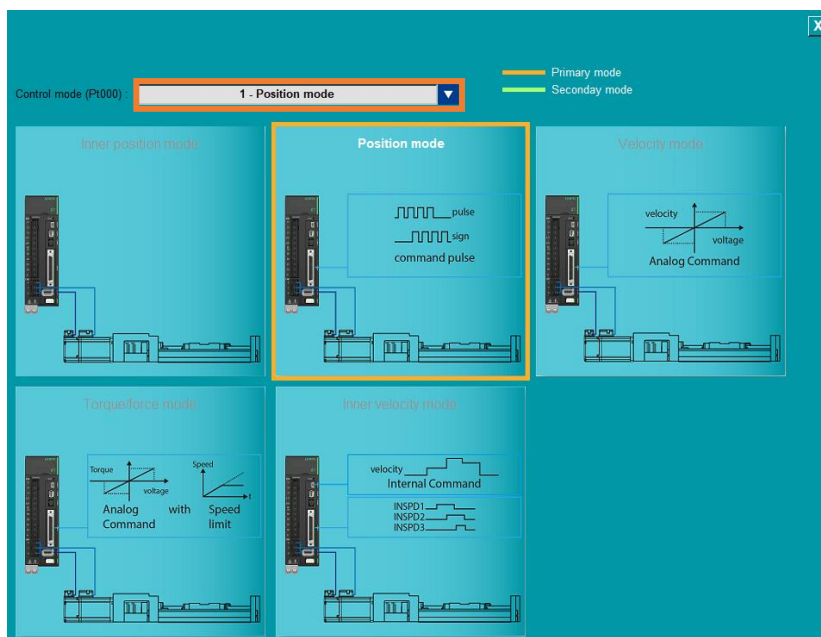

Figure 4.3.5.2



Important

Fieldbus servo drive **does not** support control mode setup.

For Fieldbus servo drive, its control mode is set by controller, so users can skip it.

Figure 4.3.5.3

Table 4.3.5.1

Selection	Description
0 – Velocity mode	Analog voltage is used as velocity command to control motor velocity. This control mode is suitable for: (1) Velocity control (2) Controller controls position loop by using the encoder pulse outputs received from the servo drive.
1 – Position mode	Pulse commands are input into the servo drive from controller. The position of the motor is determined by the number of pulses. The velocity of the motor is determined by the inputting frequency of pulses. This control mode is suitable for application which requires positioning control.
2 – Torque mode	Analog voltage is used as torque command to control motor torque. This control mode is suitable for: (1) Torque control (Pressing) (2) Controller controls position and velocity loops by using the encoder pulse outputs received from the servo drive.
3 – Internal velocity mode	Use parameters to set three internal velocity settings inside the servo drive. Use digital input signal to switch among the velocity settings. External analog command is not needed in this control mode.
4 – Internal velocity mode↔Position mode	Dual mode is the combination of internal velocity mode and other control mode. Users can switch between two control modes according to their applications.
5 – Internal velocity mode↔Velocity mode	
6 – Internal velocity mode↔Torque mode	
7 – Position mode↔Velocity mode	Dual mode is the combination of any two modes of position mode, velocity mode and torque mode. Users can switch between two control modes according to their applications.
8 – Position mode↔Torque mode	
9 – Torque mode↔Velocity mode	
10 – Internal position mode	Motion procedures are set inside the servo drive. Position control is performed by digital input signal. External pulse command is not needed in this control mode.
11 – Internal position mode↔Position mode	Dual mode is the combination of internal position mode and other control mode. Users can switch between two control modes according to their applications.
12 – Internal position mode↔Velocity mode	
13 – Internal position mode↔Torque mode	
14 – Internal velocity mode↔Internal position mode	



Information

Refer to section 8.3 to 8.9 in “E1 Series Servo Drive User Manual” for further descriptions.

4.3.6 Command Input Setup

This page will display different window based on the control mode selected in **Control Mode Setup**. Refer to the following table for the related information.

Table 4.3.6.1

Control mode	Reference
Velocity mode	section 4.3.6.1
Position mode	section 4.3.6.2
Torque mode	section 4.3.6.3
Internal velocity mode	section 4.3.6.5
Internal position mode	section 4.3.6.6



Important

If users select dual mode (such as **7 – Position mode↔Velocity mode**), users have to set both position mode’s and velocity mode’s command inputs.

4.3.6.1 Velocity mode

Follow the procedure below to complete velocity mode’s command input setup.

1. Click **Command Input Setup** to enter command input setup page.

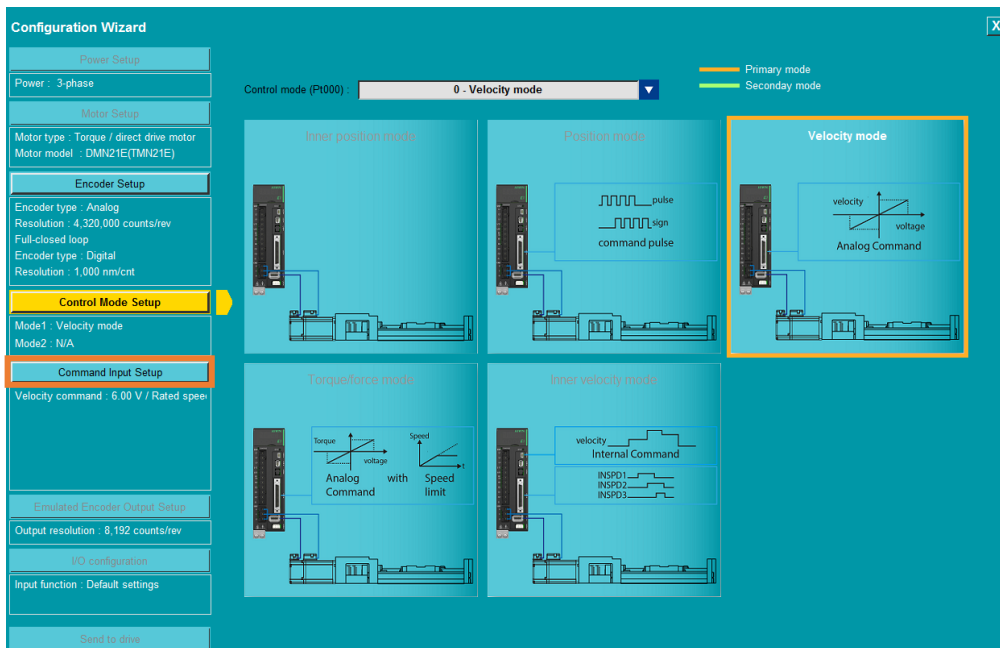

Figure 4.3.6.1.1

2. Set reference command.

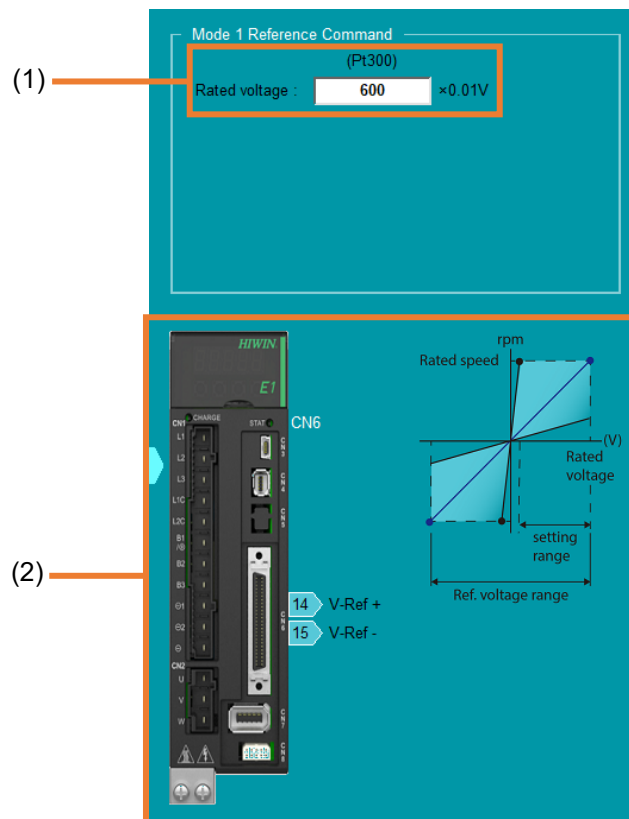

Figure 4.3.6.1.2

Table 4.3.6.1.1

No.	Item	Description
(1)	Velocity command input gain (Pt300)	Set the ratio of analog voltage and motor rated velocity. Refer to section 8.3.1 in “E1 Series Servo Drive User Manual” for the example of velocity command input.
(2)	Diagram	It shows the CN6 pin diagram of velocity command input signal and the input range diagram of velocity command voltage.

4.3.6.2 Position mode

Position mode’s command input setup shows different setting window based on servo drive model, motor setup and encoder setup.

Table 4.3.6.2.1

Servo drive model	Motor type	Reference
Standard servo drive	Rotary motor	Rotary motor’s pulse command input setup
	Linear motor	Linear motor’s pulse command input setup
Fieldbus servo drive	Servo motor	Fieldbus servo drive’s position command input setup

■ Rotary motor’s pulse command input setup

1. Click **Command Input Setup** to enter command input setup page.

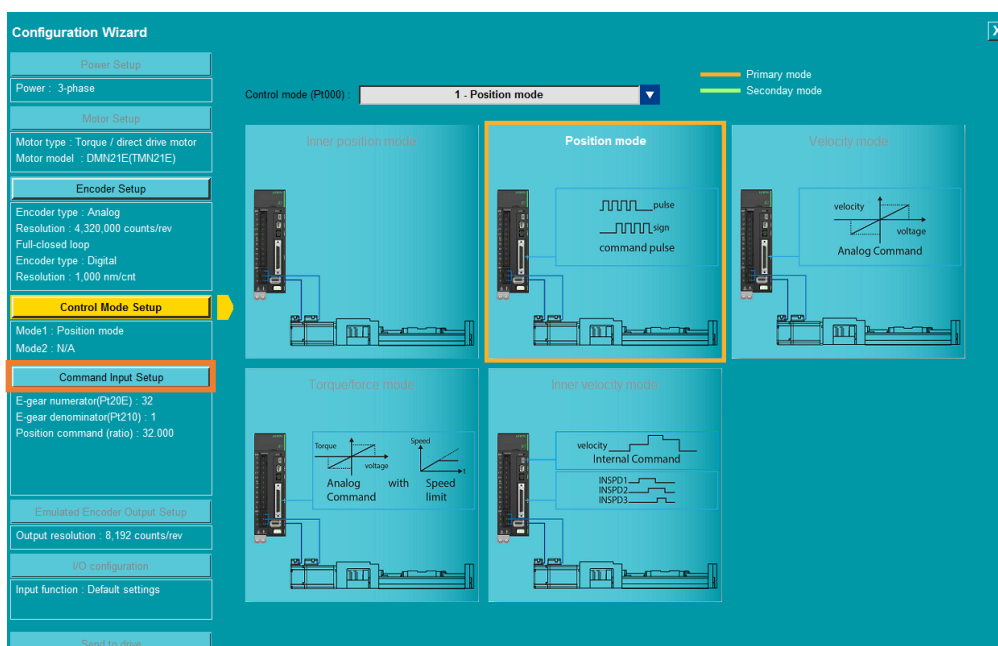

Figure 4.3.6.2.1

2. Set the related parameters of command input.

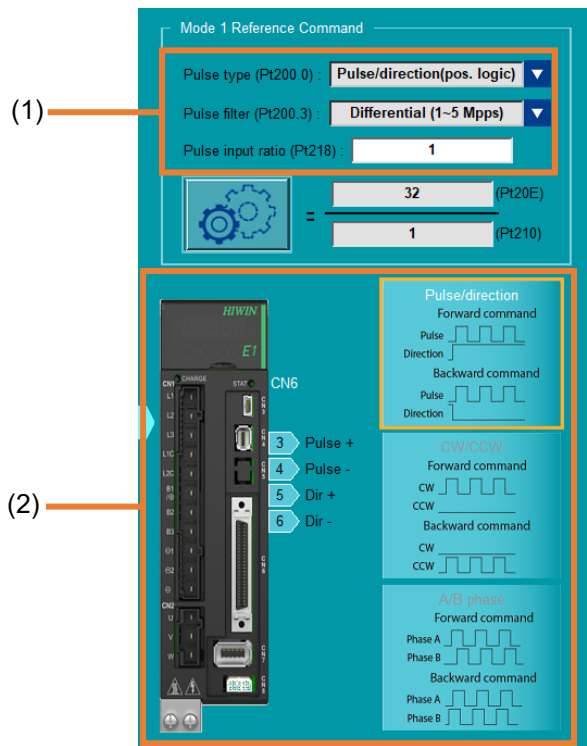



Figure 4.3.6.2.2

Table 4.3.6.2.2

No.	Item	Description
(1)	Pulse format parameters setting	Select pulse type (Pt200.0) and pulse filter (Pt200.3), and set pulse input ratio (Pt218). Refer to section 8.4 in “E1 Series Servo Drive User Manual” for further descriptions of pulse command input.
(2)	Diagram	It shows the CN6 pin diagram of pulse command input signal and the pulse signal diagram.

3. Click electronic gear ratio setting icon  to open “Electronic gear ratio setting” window for electronic gear ratio setting.

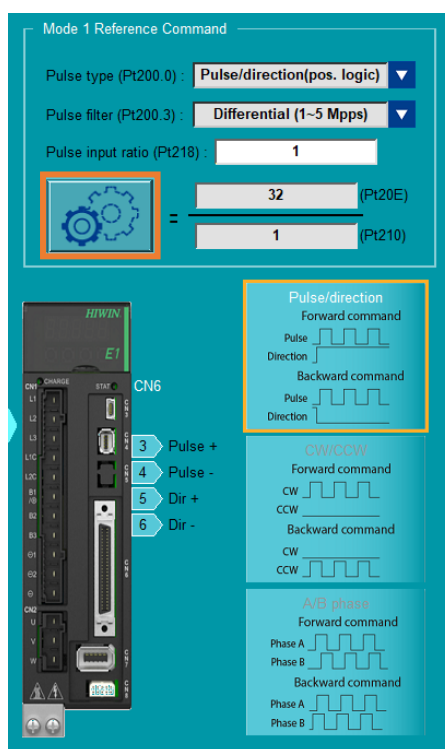

Figure 4.3.6.2.3

“Electronic gear ratio setting” window only supports **standard servo drive**, and it will display different window based on encoder setting. Refer to the following table for the related information.

Table 4.3.6.2.3

Encoder setting	Reference
Full-closed loop not activated	All mechanical structure's electronic gear ratio setting (except for linear motor and full-closed loop)
Full-closed loop activated	Full-closed loop's electronic gear ratio setting



Information

For the electronic gear ratio setting of Fieldbus servo drive's EtherCAT model (ED1F-E□-□□□ □-□□), users have to modify Pt20E and Pt210 in **Configuration Wizard**.

■ Linear motor's pulse command input setup

1. Click **Command Input Setup** to enter command input setup page.

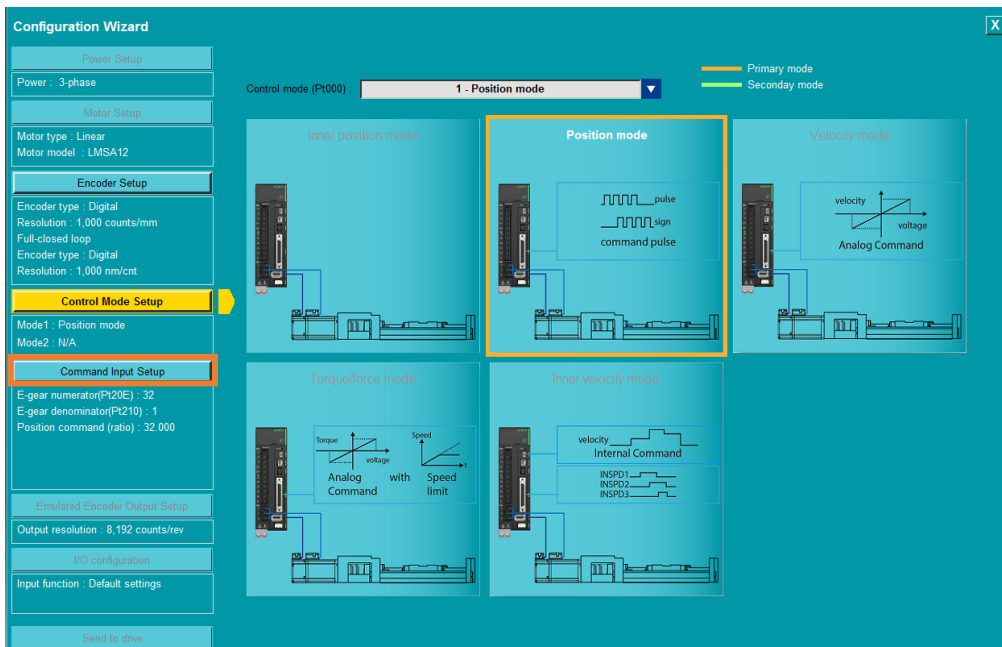

Figure 4.3.6.2.4

2. Set the related parameters of command input.

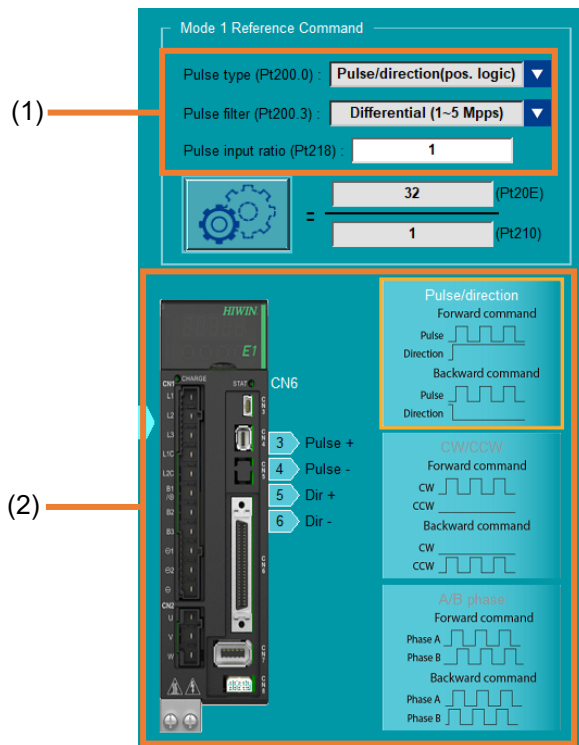



Figure 4.3.6.2.5

Table 4.3.6.2.4

No.	Item	Description
(1)	Pulse format parameters setting	Select pulse type (Pt200.0) and pulse filter (Pt200.3), and set pulse input ratio (Pt218). Refer to section 8.4 in “E1 Series Servo Drive User Manual” for further descriptions of pulse command input.
(2)	Diagram	It shows the CN6 pin diagram of pulse command input signal and the pulse signal diagram.

- Click electronic gear ratio setting icon  to open “Electronic gear ratio setting” window for electronic gear ratio setting.

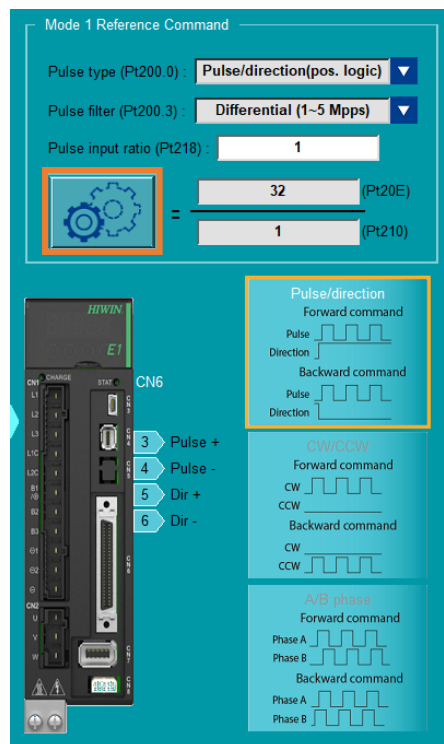

Figure 4.3.6.2.6

“Electronic gear ratio setting” window only supports **standard servo drive**, and it will display different window based on encoder setting. Refer to [Linear motor’s electronic gear ratio setting](#) for the related information.

■ Fieldbus servo drive's position command input setup

1. Click **Command Input Setup** to enter command input setup page.

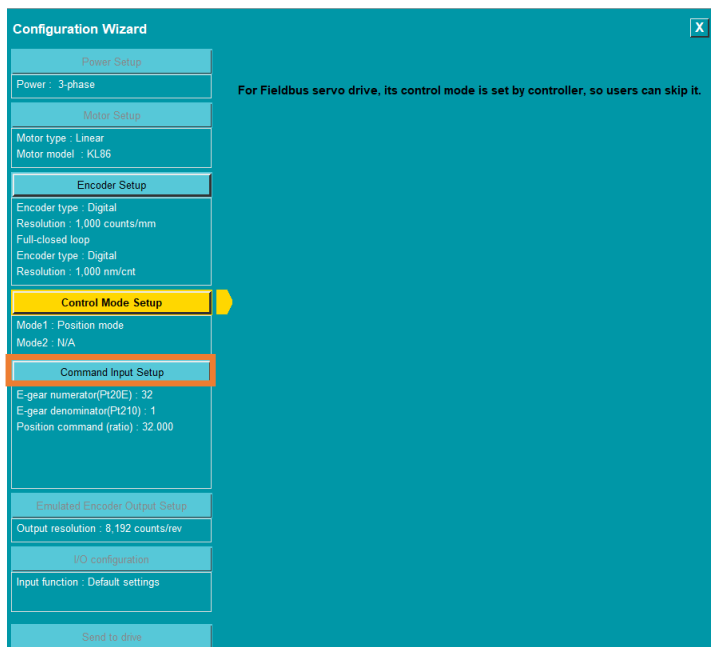

Figure 4.3.6.2.7

2. Set the related parameter of command input.

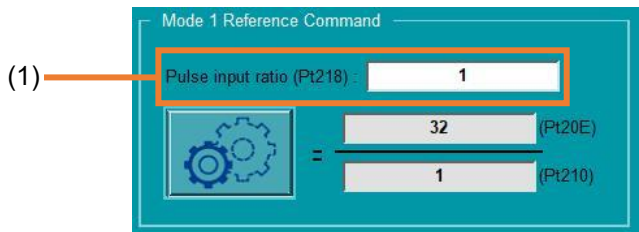

Figure 4.3.6.2.8

Table 4.3.6.2.5

No.	Item	Description
(1)	Pulse format parameters setting	Set pulse input ratio (Pt218). Refer to section 8.4 in “E1 Series Servo Drive User Manual” for further descriptions of pulse command input.



Important

Fieldbus servo drive **does not** support electronic gear ratio setting. Except for EtherCAT model (ED1F-E□-□□□□-□□), the electronic gear ratio is fixed as 1:1.

4.3.6.3 Electronic gear ratio setting

This function only supports position mode, internal position mode and dual mode which includes one of the two modes mentioned above (refer to **Control Mode Setup**). “Electronic gear ratio setting” window only supports **standard servo drive**, and it will display different window based on motor type and encoder setting. Refer to the following table for the related information.



For the electronic gear ratio setting of Fieldbus servo drive’s EtherCAT model (ED1F-E□-□□□ □-□□), users have to modify Pt20E and Pt210 in **Configuration Wizard**.

Information

Table 4.3.6.3.1

Motor type	Encoder setting	Reference
Rotary motor	Full-closed loop not activated	All mechanical structure’s electronic gear ratio setting (except for linear motor and full-closed loop)
	Full-closed loop activated	Full-closed loop’s electronic gear ratio setting
Linear motor	No full-closed loop function	Linear motor’s electronic gear ratio setting

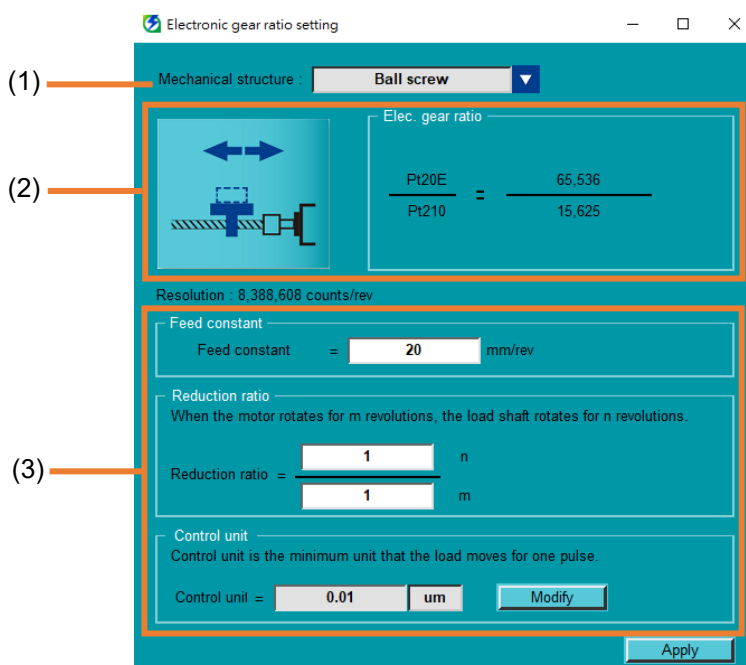

Figure 4.3.6.3.1

Table 4.3.6.3.2

No.	Item	Description
(1)	Menu of mechanical structure	Select the desired mechanical structure.

(2)	Diagram of mechanical structure and the calculated result of electronic gear ratio	Display the diagram of mechanical structure selected by users and the calculated result of electronic gear ratio.
(3)	Parameters of electronic gear ratio	Key in feed constant, reduction ratio and control unit.





Important

There are eight kinds of mechanical structures, as the following table shows. “Linear motor” and “Full-closed loop” will be automatically selected based on motor type and encoder setting.

If the mechanical structure is unknown or there is no suitable option, select “Other”.

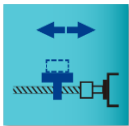
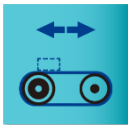
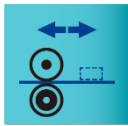
Table 4.3.6.3.3

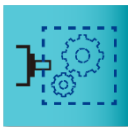
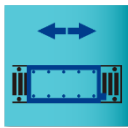
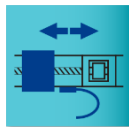
 Ball screw	 Belt and pulley	 Roll feed	 Rack and pinion
 Round table	 Other	 Linear motor	 Full-closed loop

■ All mechanical structure’s electronic gear ratio setting (except for linear motor and full-closed loop)

1. Select mechanical structure.

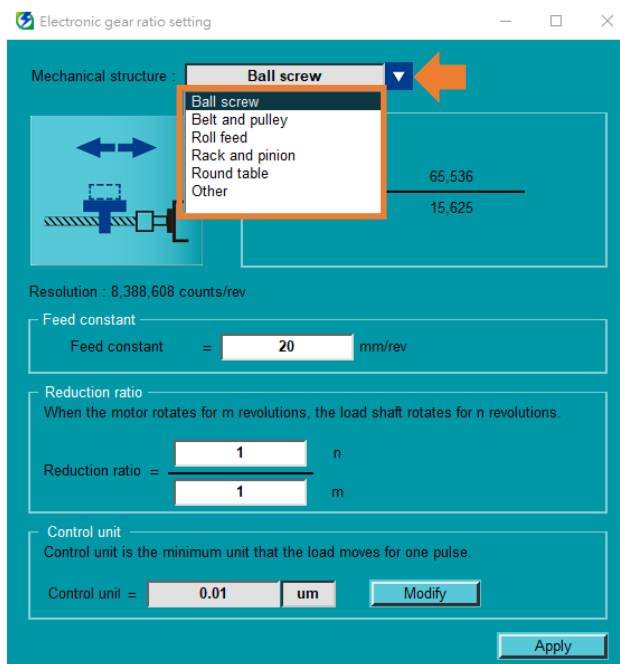

Figure 4.3.6.3.2

2. Key in feed constant and reduction ratio.

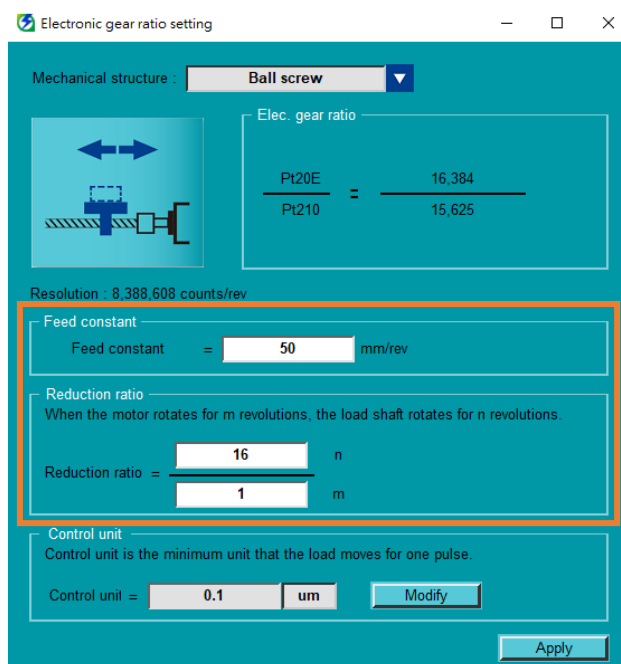

Figure 4.3.6.3.3



Information

- (1) Refer to section 6.11 in “E1 Series Servo Drive User Manual” for the description of control unit.
- (2) To modify control unit, click **Modify**.

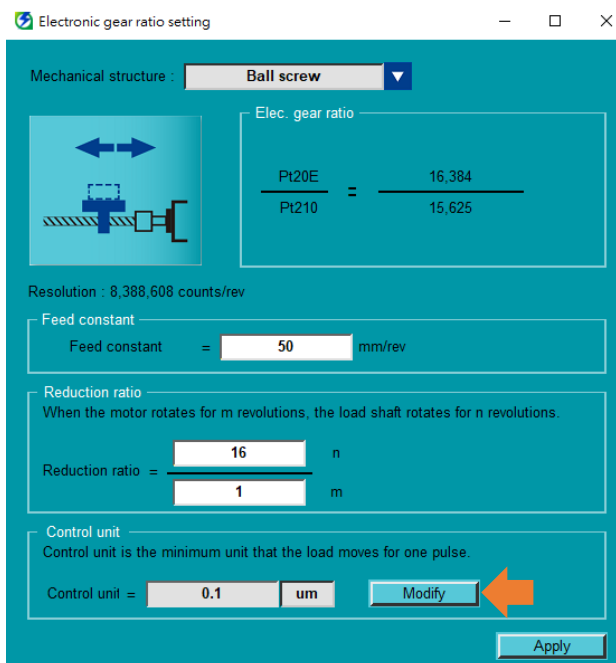

Figure 4.3.6.3.4

After selecting unit and keying in control unit, click **OK**.

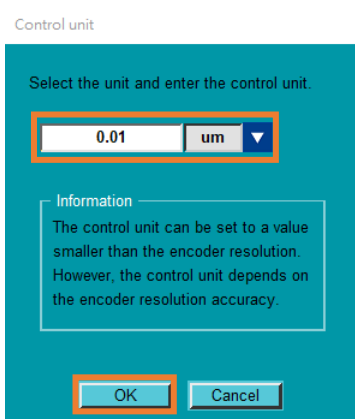

Figure 4.3.6.3.5

When control unit is updated, electronic gear ratio will be recalculated, and the reminder **User modified** will appear.

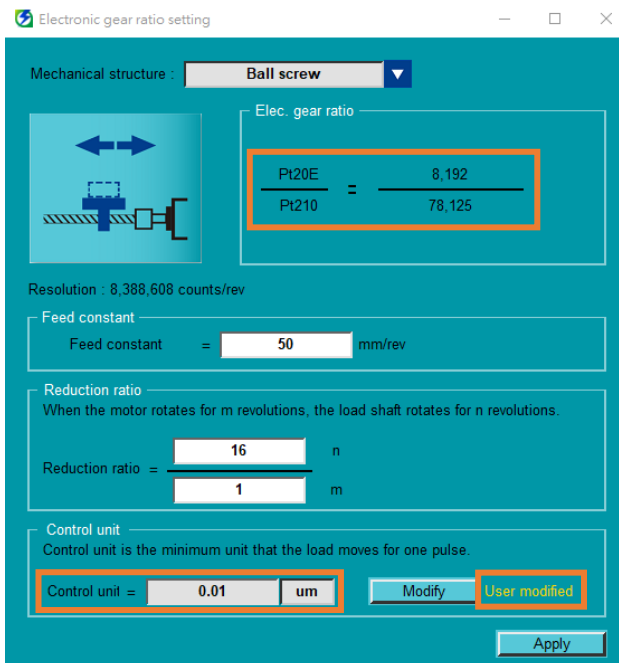

Figure 4.3.6.3.6

3. Confirm the calculated result of electronic gear ratio, and click **Apply**.

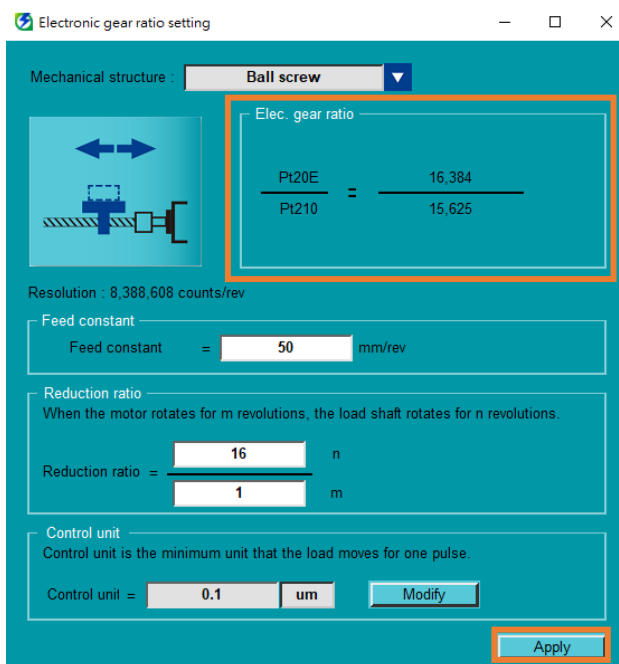

Figure 4.3.6.3.7

■ Full-closed loop's electronic gear ratio setting

If **Activate full-closed loop** in **Encoder Setup** is checked, mechanical structure will automatically select **Full-closed loop**. To modify control unit, click **Modify**, key in control unit, confirm the calculated result of electronic gear ratio, and click **Apply**.

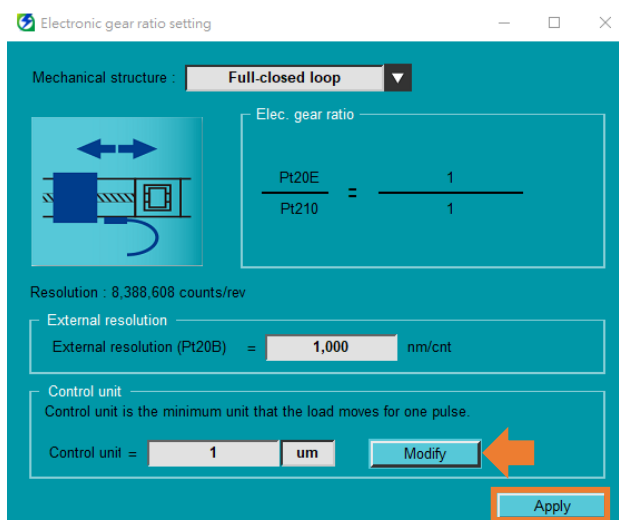

Figure 4.3.6.3.8

■ Linear motor's electronic gear ratio setting

If the motor type is **linear motor**, mechanical structure will automatically select **Linear motor**. To modify control unit, click **Modify**, key in control unit, confirm the calculated result of electronic gear ratio, and click **Apply**.

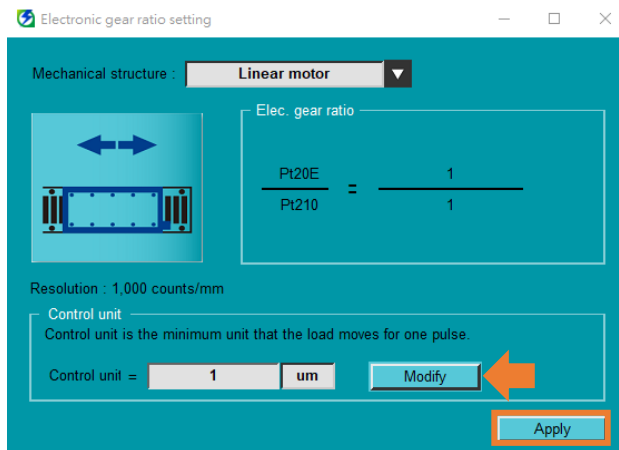

Figure 4.3.6.3.9

4.3.6.4 Torque mode

Follow the procedure below to complete torque mode's command input setup.

1. Click **Command Input Setup** to enter command input setup page.

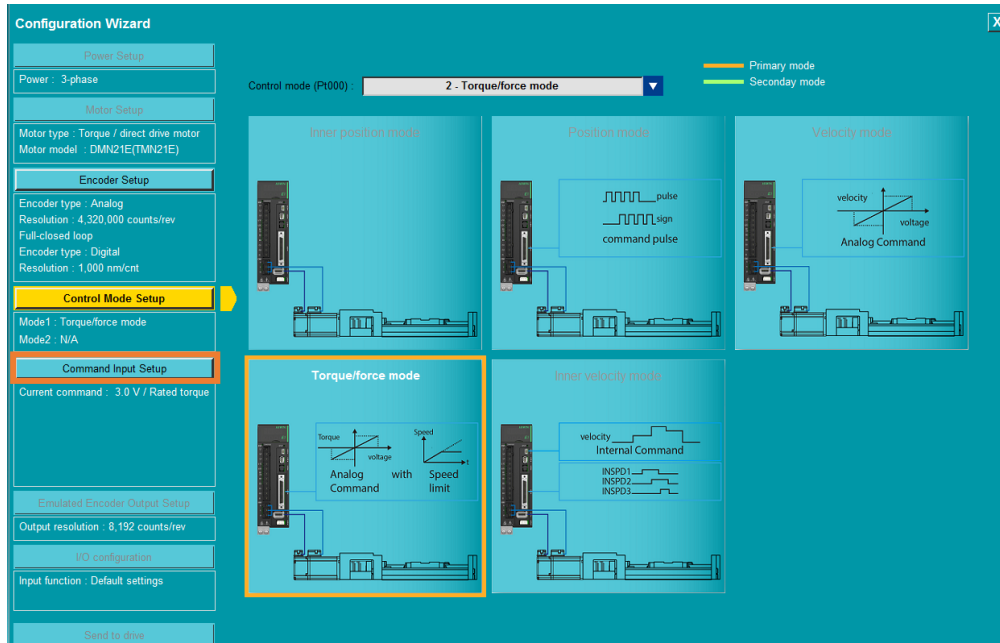

Figure 4.3.6.4.1

2. Set reference command.

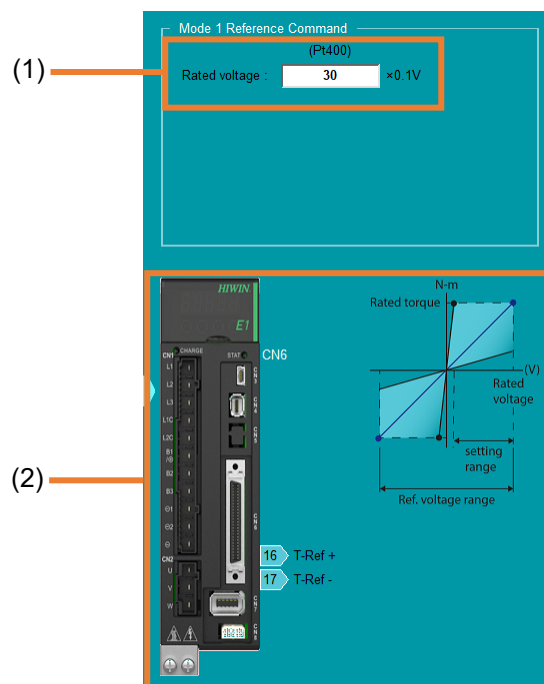

Figure 4.3.6.4.2

Table 4.3.6.4.1

No.	Item	Description
(1)	Torque command input gain (Pt400)	Set the ratio of analog voltage and motor rated torque. Refer to section 8.5 in “E1 Series Servo Drive User Manual” for the example of torque command input.
(2)	Diagram	It shows the CN6 pin diagram of torque command input signal and the input range diagram of torque command voltage.

4.3.6.5 Internal velocity mode

Follow the procedure below to complete internal velocity mode’s command input setup.

1. Click **Command Input Setup** to enter command input setup page.

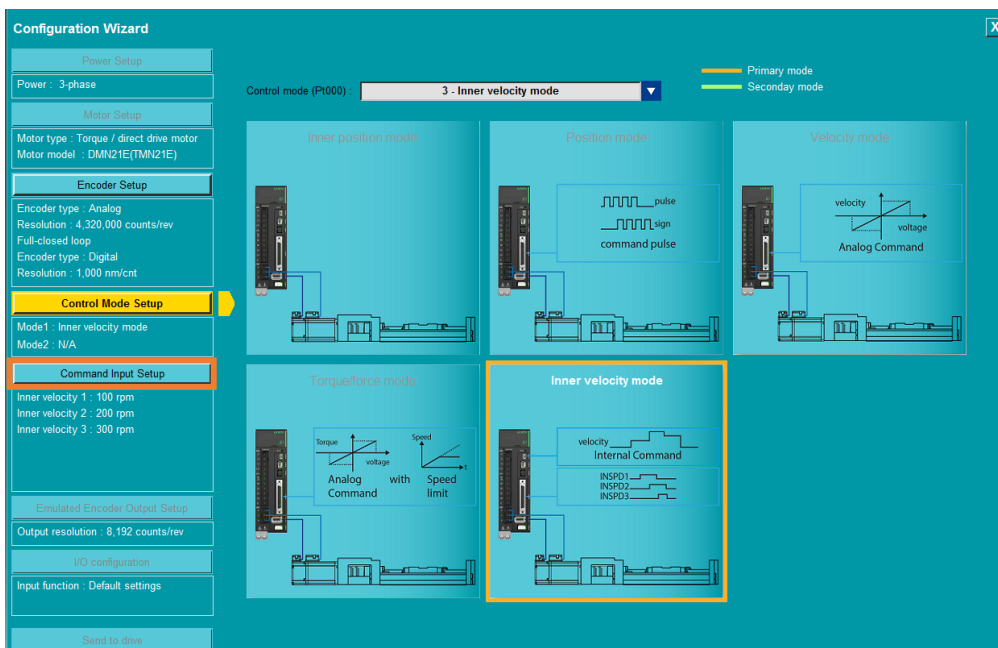

Figure 4.3.6.5.1

2. Set reference command.

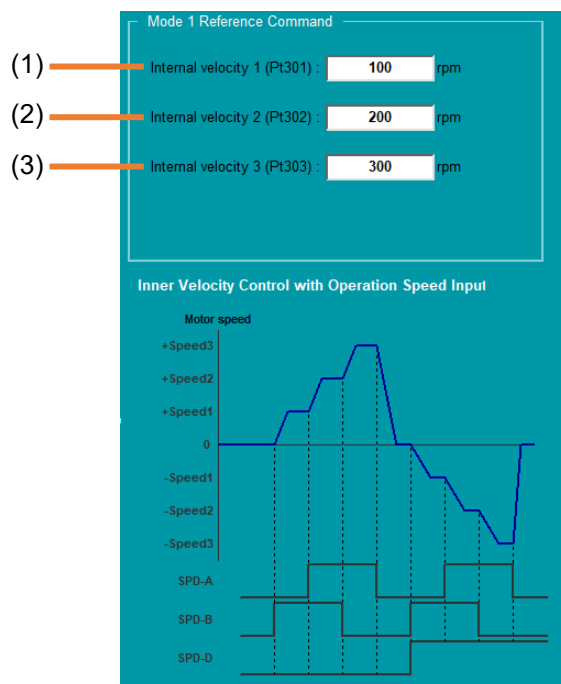

Figure 4.3.6.5.2

Table 4.3.6.5.1

No.	Item	Description
(1)	Internal velocity 1	Key in internal set velocity 1 (Pt301).
(2)	Internal velocity 2	Key in internal set velocity 2 (Pt302).
(3)	Internal velocity 3	Key in internal set velocity 3 (Pt303).

4.3.6.6 Internal position mode

Follow the procedure below to complete internal position mode's command input setup.

1. Click **Command Input Setup** to enter command input setup page.

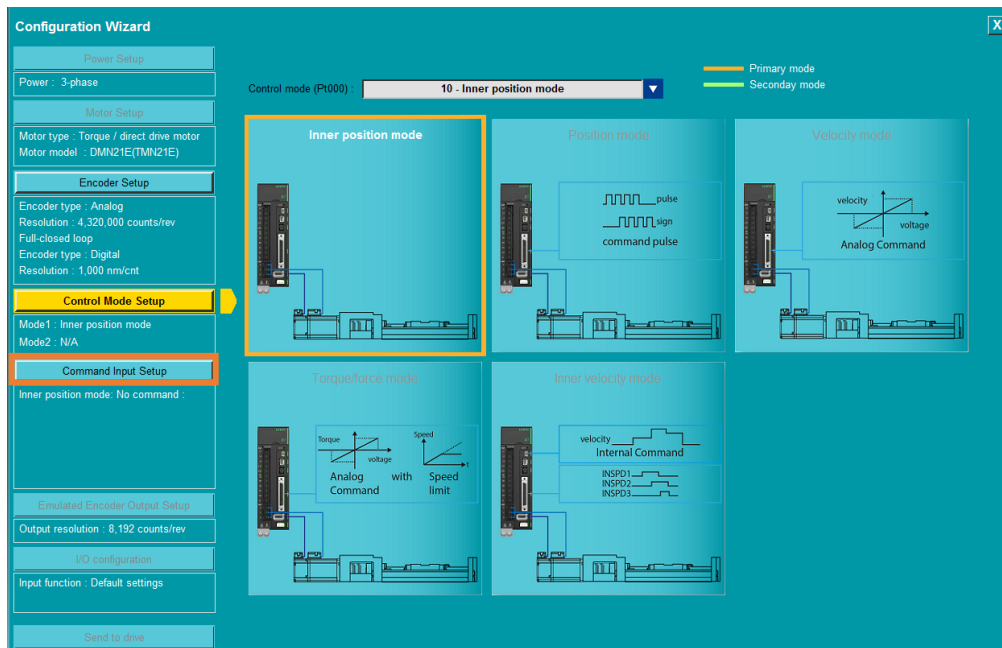

Figure 4.3.6.6.1

2. Set reference command.

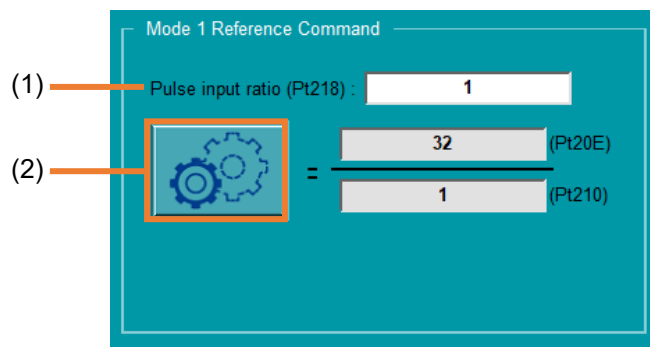

Figure 4.3.6.6.2

Table 4.3.6.6.1

No.	Item	Description
(1)	Pulse input ratio	Key in command pulse input multiplier (Pt218).
(2)	Electronic gear ratio setting	“Electronic gear ratio setting” window only supports standard servo drive , and it will display different window based on motor type and encoder setting. Refer to Position mode and Electronic gear ratio setting .

4.3.7 Emulated Encoder Output Setup

The function of encoder pulse output is to provide position feedback for host controller. During motor operation, this function will send pulse signals with the output format of A/B phase to host controller based on the set encoder output ratio. Before using this function, confirm servo drive's output bandwidth, host controller's receiving bandwidth and motor's maximum operating velocity.

The procedure of emulated encoder output setup is as below.

1. Click **Emulated Encoder Output Setup** to enter emulated encoder output setup page.

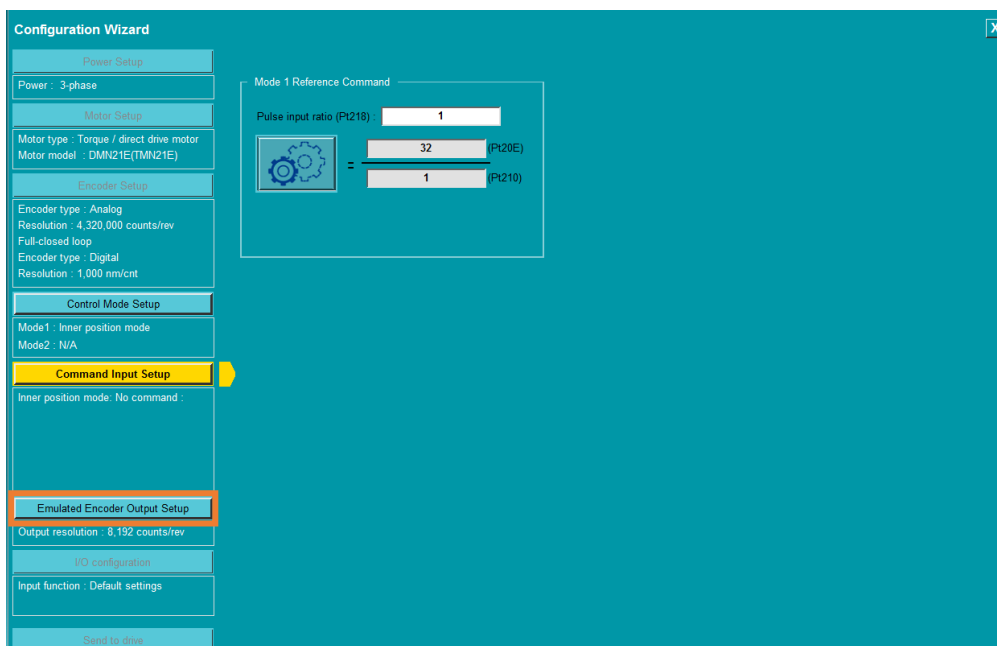

Figure 4.3.7.1

2. Key in emulated encoder output resolution (Pt212).

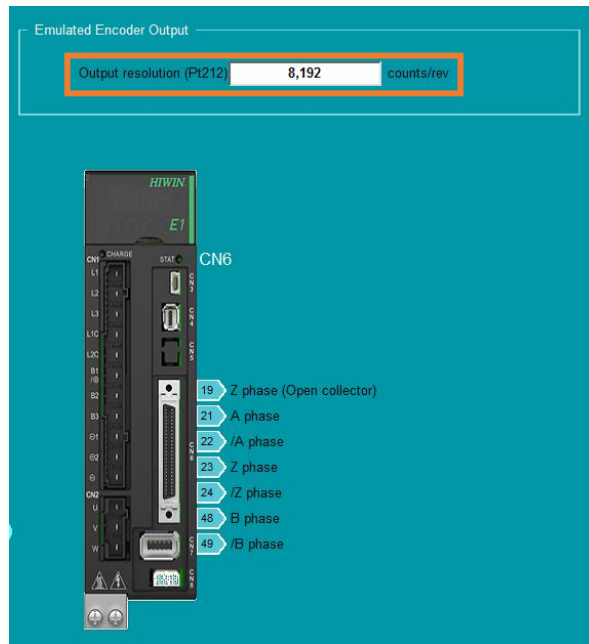

Figure 4.3.7.2



Information

The following figure shows the CN6 pin assignment of emulated encoder output signals for Fieldbus servo drive.

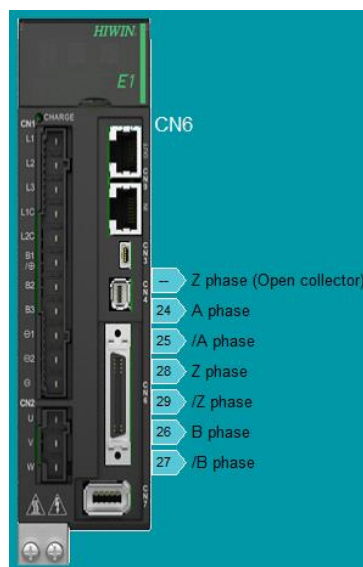

Figure 4.3.7.3

4.3.8 I/O configuration

Configure servo drive's digital input signals and digital output signals. The procedure of I/O configuration is as below.

1. Click **I/O configuration** to enter I/O configuration page.

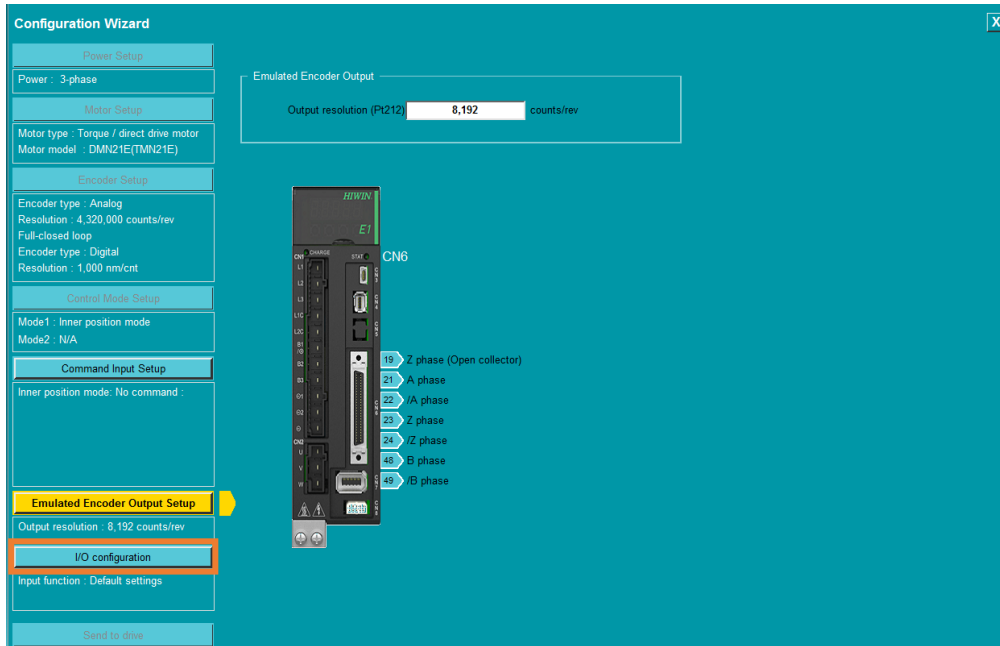

Figure 4.3.8.1

2. The setting method is the same as that in section 4.5.

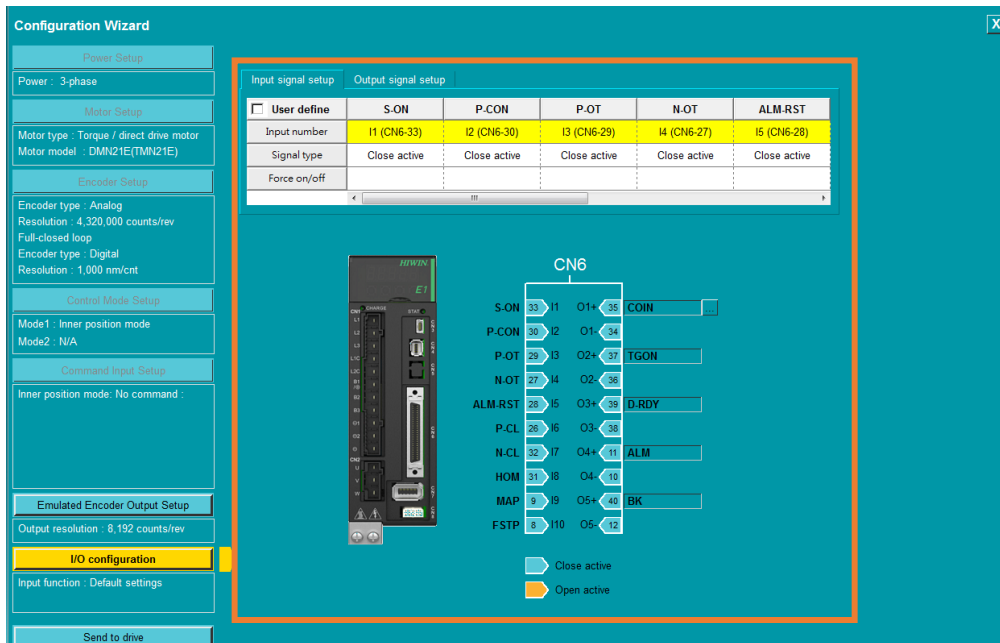

Figure 4.3.8.2

Table 4.3.8.1

Function	Reference
Modify configuration of digital input signals	section 4.5.2
Modify configuration of digital output signals	section 4.5.3

4.3.9 Send to drive

List all the parameters set by users in Configuration Wizard. After confirming the correctness, users can send the parameters to servo drive. The procedure of send to drive is as below.

1. Click **Send to drive** to enter send to drive page.

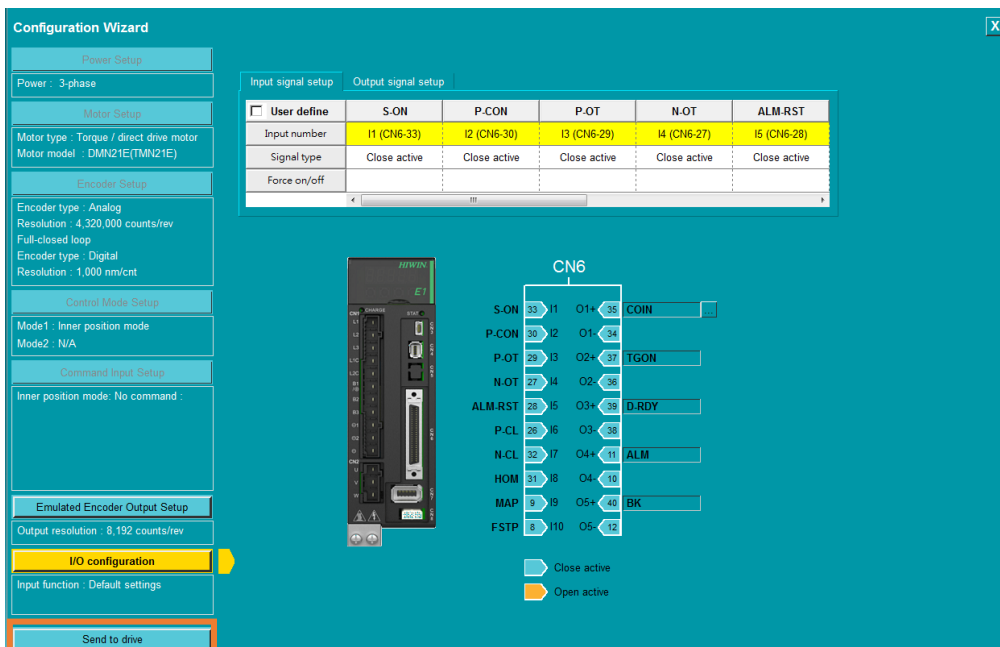

Figure 4.3.9.1

2. If the setting value to be sent to drive is different from the current value in the servo drive, it will be displayed in yellow background. After ensuring all the parameters are correctly set, click **Send to drive**.

Parameters	Current setting	New setting	Unit
[Power Parameter]			
AC power input (Pt00B.2)	Three-phase AC power	Three-phase AC power	N/A
[Motor Parameter]			
Type	AC servo	Torque / direct drive motor	N/A
Model name		DMN21E(TMN21E)	N/A
Manufacturer		HIWIN	N/A
Peak current	9.89949	5.7	A-rms
Continuous current	2.47487	1.9	A-rms
Resistance	4.1	2.55	Ohm
Inductance	9.26	8.4	mH
Force/torque constant	0.767918	0.17	Nm/A-rms
Pole number	8	10	N/A
Pole pair pitch	8.38861e+006	4.32e+006	mm
Peak time	1	1	sec
Inertia	2.7e-005	4e-005	kg*(m ²)
Moving mass	2	2	N/A
Motor direction	10922	-10922	N/A
Current tau	1.61336e-005	1.61336e-005	N/A
Rated speed	600	1500	rpm
Rated speed	1500	1500	mm/s
Motor mass	2	2	Kg

Figure 4.3.9.2

- Click **Ok**. At this time, the servo drive will be power cycled.

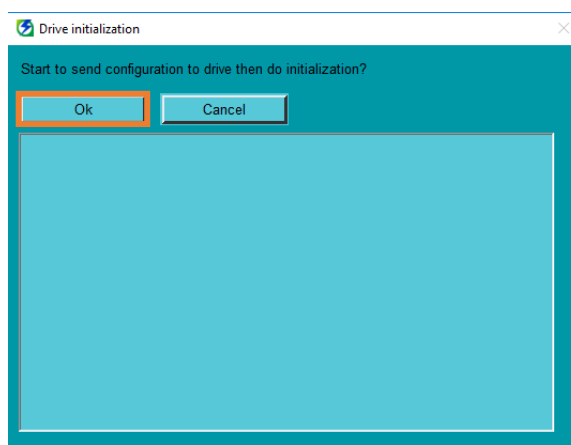

Figure 4.3.9.3

- After the servo drive is power cycled, servo drive configuration is done.

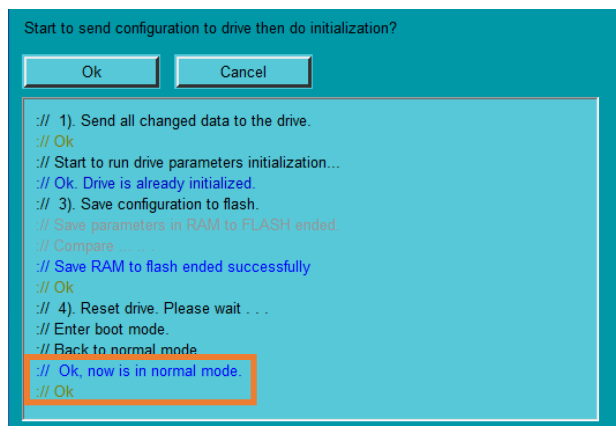

Figure 4.3.9.4

4.4 Parameters Setup

4.4.1 Brief introduction

Based on the classified servo drive Pt parameters list, users can set or compare the Pt parameters different from factory default values. Besides, users can create, edit, save and load personalized parameters list.

Edit parameters

Users can edit, compare, save and load the servo drive related Pt parameters via Pt parameters page.

Create a servo drive parameters file

Users can quickly create a servo drive parameters file (*.prm) in the application environment, and load servo drive parameters file (*.prm) in other environments.

Send the parameters to servo drive

Users can send the changed servo drive parameters to servo drive.

Reset drive

Users can send commands to reset servo drive via HMI. The effect is the same as power cycling servo drive.

Set to factory default

Users can restore servo drive parameters to factory default.

4.4.2 Edit parameters

Users can modify all servo drive parameters via Pt parameters editing page. This page also provides the following functions:

- ◆ List all the modified Pt parameters for quick view.
- ◆ View or modify non-Pt series parameters.
- ◆ Save personalized parameters list.

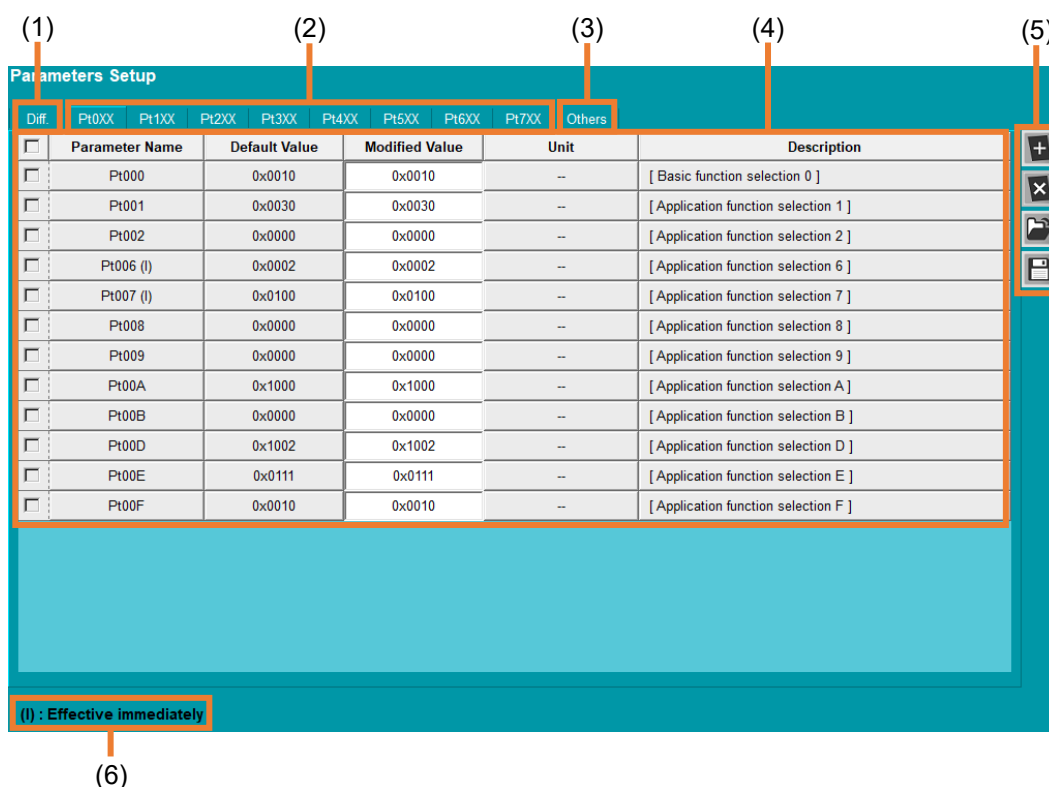

Figure 4.4.2.1

Table 4.4.2.1

No.	Item	Description	Reference
(1)	Compare parameters	Display the parameters different from default value.	section 4.4.2.1
(2)	Set Pt parameters	Users can set Pt parameters in these tabs.	section 4.4.2.2
(3)	Set personalized parameters	Users can set personalized parameters in this tab.	section 4.4.2.3
(4)	Display list of parameters	Display the parameters currently available for users to edit.	--
(5)	Editing function for personalized parameters	Users can edit, save and load personalized parameters list.	section 4.4.2.3

(6)	Effective time of parameters	If there is an (I) behind the parameter name, it indicates the parameter will immediately be effective when users change its value. There is no need to save the changed value to servo drive and power cycle it.	section 4.4.2.4
-----	------------------------------	--	-----------------

4.4.2.1 Parameters comparison

Follow the procedure below to quickly view all the modified Pt parameters.

1. Click “Open Parameters Setup” icon in the toolbar to open “Parameters Setup” window.

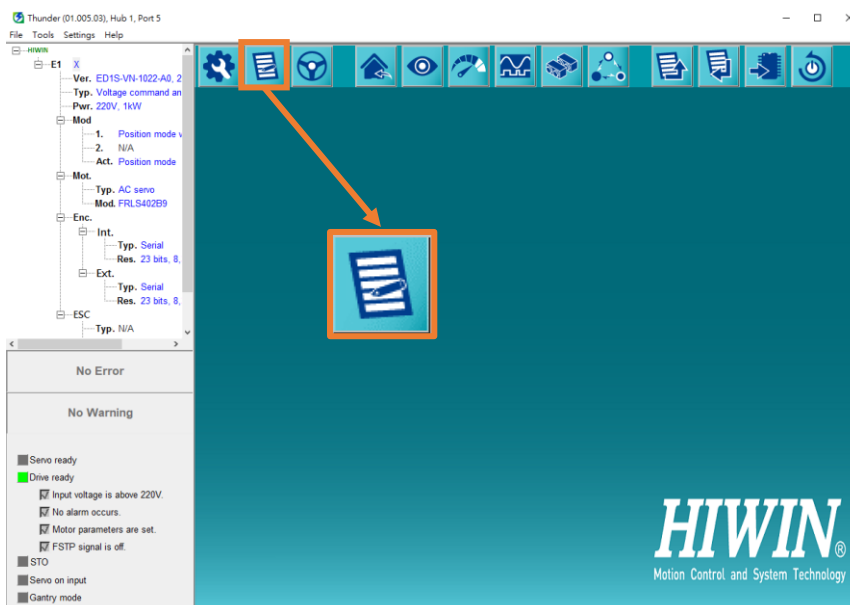

Figure 4.4.2.1.1

2. Select **Diff.** tab. This tab lists all the servo drive Pt parameters different from their default values. Users can also modify these Pt parameters here.

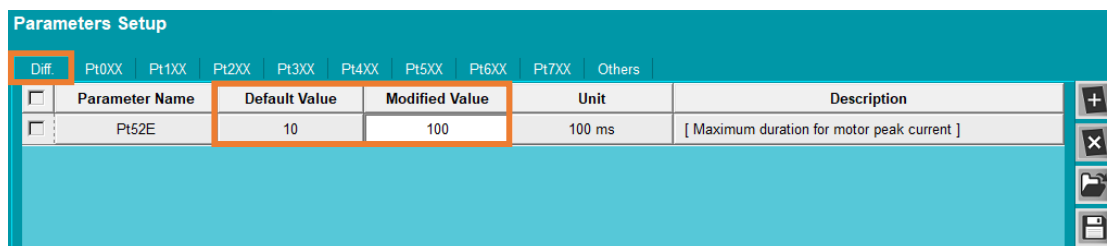

Figure 4.4.2.1.2

4.4.2.2 Set Pt parameters

Servo drive Pt parameters are classified into eight categories, Pt0XX to Pt7XX. Each parameter can be classified as setup parameter or tuning parameter. Users can set the related Pt parameters based on the category.

Table 4.4.2.2.1

Category	Description
Pt0XX	Parameters for setting basic function
Pt1XX	Parameters for tuning
Pt2XX	Position-related parameters
Pt3XX	Velocity-related parameters
Pt4XX	Torque-related parameters
Pt5XX	Parameters for I/O setting
Pt6XX	Parameters for regenerative resistor setting
Pt7XX	Parameters for internal homing

Diff.	Pt0XX	Pt1XX	Pt2XX	Pt3XX	Pt4XX	Pt5XX	Pt6XX	Pt7XX	Others
<input type="checkbox"/>	Parameter Name	Default Value	Modified Value	Unit	Description				
<input type="checkbox"/>	Pt200	0x0000	0x0000	--	[Position command form selection]				
<input type="checkbox"/>	Pt207	0x0000	0x0000	--	[Position control function selection]				
<input type="checkbox"/>	Pt209	1	1	1 times	[Number of times for encoder feedback interpolation com.				
<input type="checkbox"/>	Pt20A	20000	20000	1 um	[Feed length of external encoder]				
<input type="checkbox"/>	Pt20B	1000	1000	1 nm	[Linear unit length (resolution) of external encoder]				

Figure 4.4.2.2.1

Follow the procedure below to set Pt parameters.

1. Double-click Pt parameter's **Modified Value** column to open parameters modifying window.

Diff.	Pt0XX	Pt1XX	Pt2XX	Pt3XX	Pt4XX	Pt5XX	Pt6XX	Pt7XX	Others
<input type="checkbox"/>	Parameter Name	Default Value	Modified Value	Unit	Description				
<input type="checkbox"/>	Pt200	0x0000	0x0000	--	[Position command form selection]				
<input type="checkbox"/>	Pt207	0x0000	0x0000	--	[Position control function selection]				

Figure 4.4.2.2.2

2. Modify the parameter and press Enter key on the keyboard.

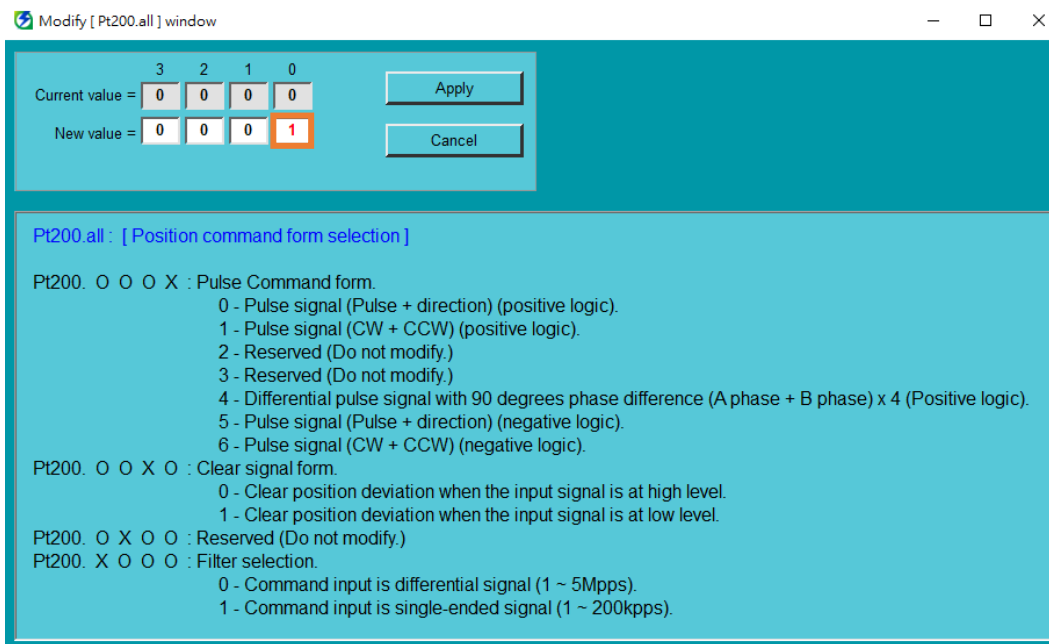

Figure 4.4.2.2.3

3. After the modification, click **Apply**.

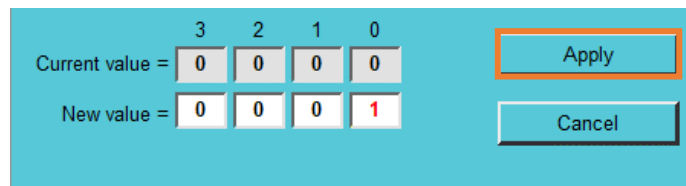

Figure 4.4.2.2.4



Information

If there is no **(I)** behind the parameter name, after clicking **Apply**, users should **Send to drive** and **Reset drive** to make the parameter be effective.

4.4.2.3 User-defined parameters

Users can define non-Pt parameters list. Refer to the following table for the functions.

Table 4.4.2.3.1

Item	Reference
Add new parameter	Add new parameter
Delete selected parameter	Delete selected parameter
Save parameter list as a file	Save parameter list as a file
Load parameters from file	Load parameters from file

■ Add new parameter

1. Click “Add new parameter” icon to open parameters adding window.

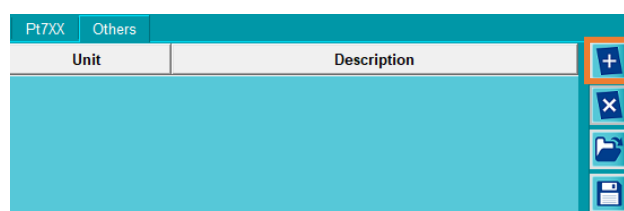

Figure 4.4.2.3.1

2. Key in the parameter name to be added.

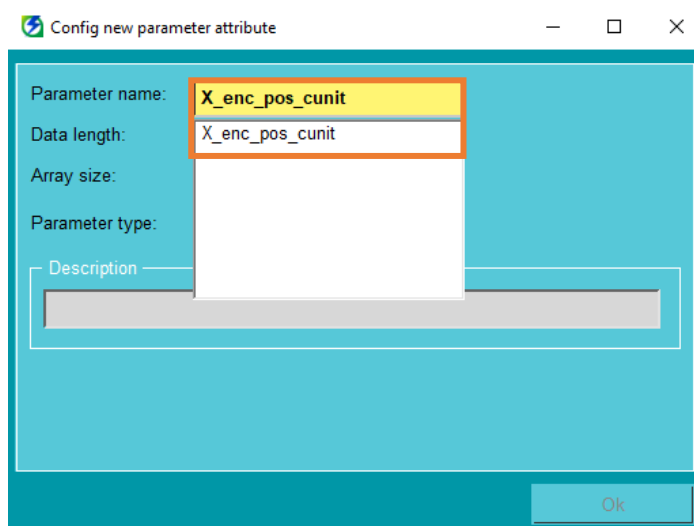

Figure 4.4.2.3.2

3. Optionally add the description and press Enter key on the keyboard.

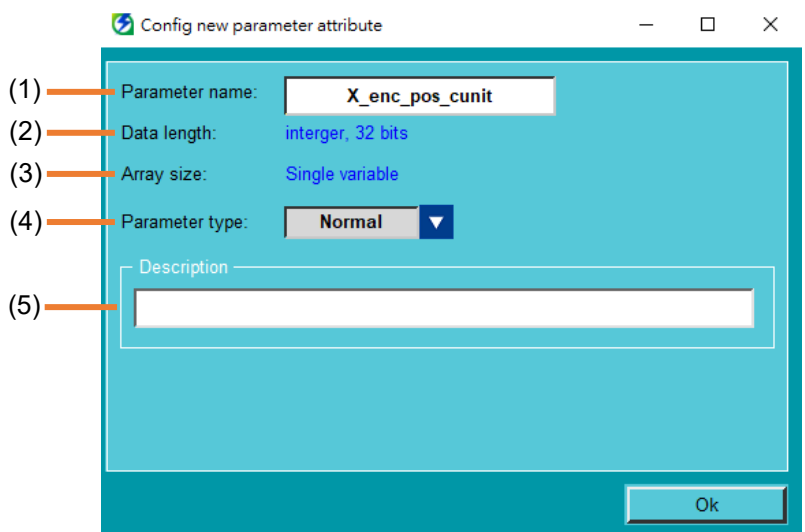

Figure 4.4.2.3.3

Table 4.4.2.3.2

No.	Item	Description
(1)	Parameter name column	Users can search for user-defined parameters here.
(2)	Parameter data length	It is the data definition for user-defined parameter in the servo drive.
(3)	Parameter array size	It is the data definition for user-defined parameter in the servo drive.
(4)	Parameter display type	It is the type that user-defined parameter is displayed in the list.
(5)	Description column	Users can optionally write the description related to the parameter.

4. Click **Ok**. Adding new parameter to parameters list succeeds.

Diff.	Pt0XX	Pt1XX	Pt2XX	Pt3XX	Pt4XX	Pt5XX	Pt6XX	Pt7XX	Others	
<input type="checkbox"/>	Parameter Name	Default Value	Modified Value	Unit	Description					
<input type="checkbox"/>	X_enc_pos_cunit	N/A	98836		[example for add]					

Figure 4.4.2.3.4

■ Delete selected parameter

1. Check the parameter to be deleted.

Diff.	Pt0XX	Pt1XX	Pt2XX	Pt3XX	Pt4XX	Pt5XX	Pt6XX	Pt7XX	Others
<input checked="" type="checkbox"/>	Parameter Name		Default Value	Modified Value		Unit			
<input checked="" type="checkbox"/>	X_enc_pos_cunit		N/A	98836					

Figure 4.4.2.3.5



Information

Users can check the box on the left side of Parameter Name to select all the parameters with one click.

Diff.	Pt0XX	Pt1XX	P
<input type="checkbox"/>	Parameter Name		
<input type="checkbox"/>	X_enc_pos_cunit		

Figure 4.4.2.3.6

2. Click “Delete selected parameter” icon.

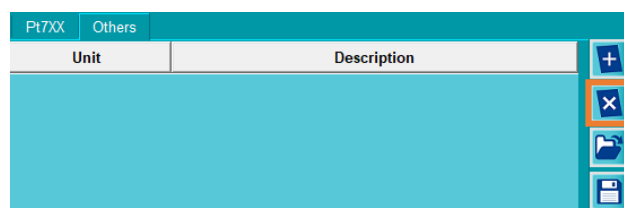

Figure 4.4.2.3.7

3. A message window that the parameter is successfully deleted will pop up. Click **OK**.

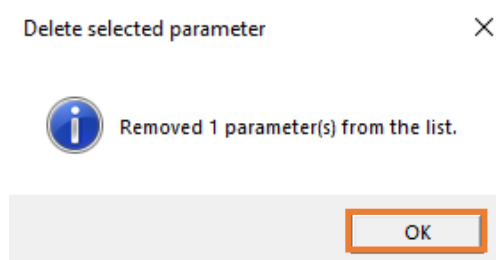

Figure 4.4.2.3.8

■ Save parameter list as a file

1. Click “Save parameter list as a file” icon.

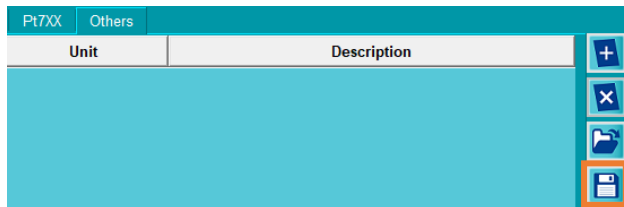

Figure 4.4.2.3.9

2. Key in file name of personalized Pt parameters list file (*.desc), select archive path, and click **Save**.

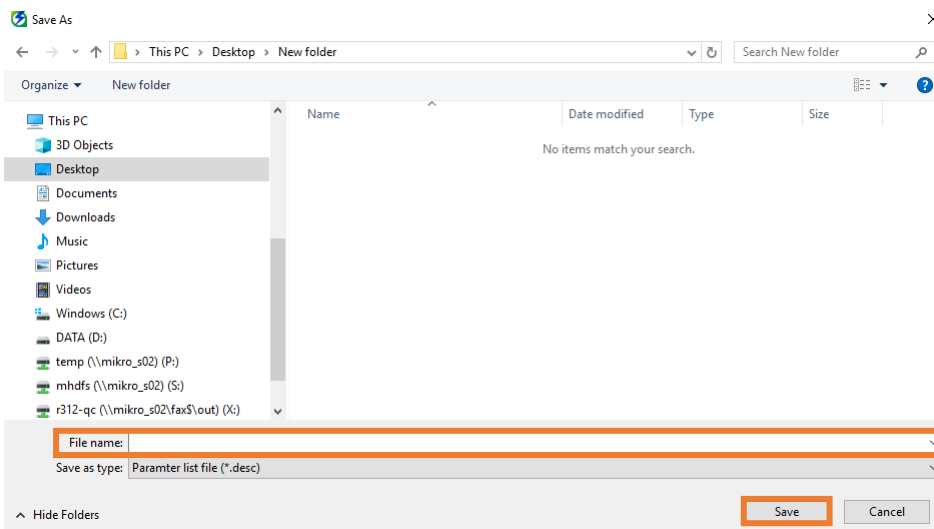

Figure 4.4.2.3.10

■ Load parameters from file

1. Click “Load parameters from file” icon.

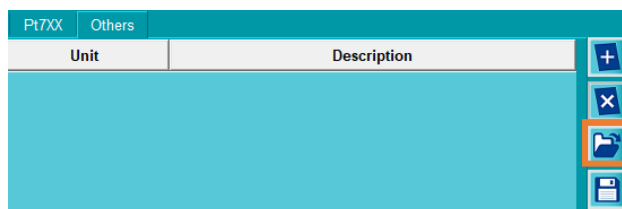

Figure 4.4.2.3.11

2. Select personalized Pt parameters list file (*.desc), and click **Open**.

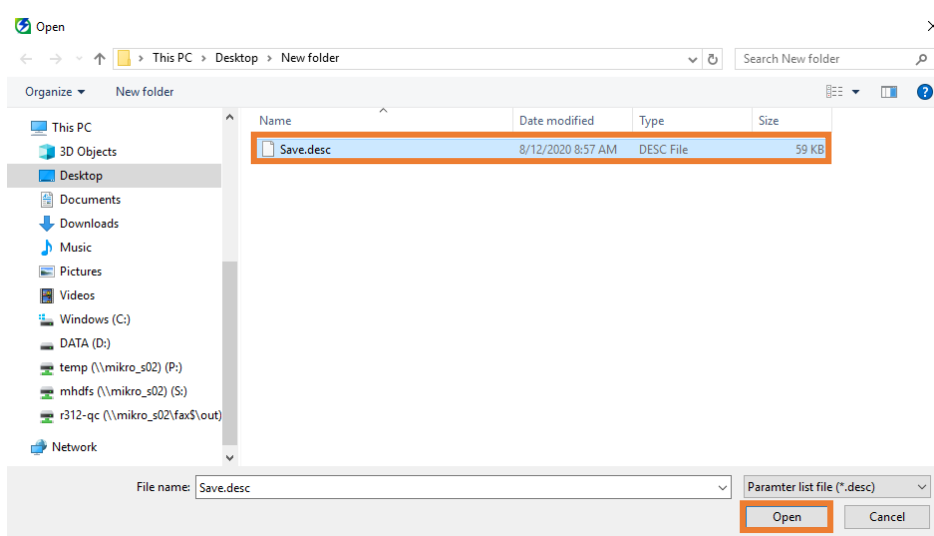

Figure 4.4.2.3.12

3. Read the message window and click **Yes** to load personalized Pt parameters list file (*.desc).

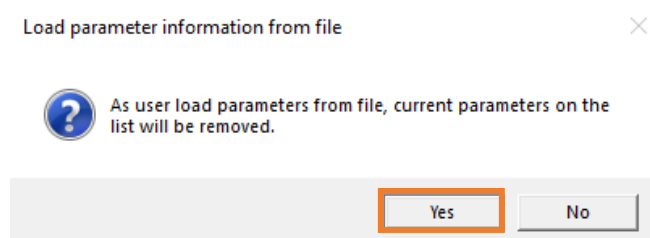

Figure 4.4.2.3.13

4.4.2.4 Send to drive

If users modify non-immediately effective parameter in **Set Pt parameters**, warning AL941 (refer to section 13.3 in “E1 Series Servo Drive User Manual” for the detailed descriptions of warning) will pop up on the left side of Thunder main window to remind users to save the parameter and reset servo drive. Refer to section 4.4.4 and 4.4.5 for the operation procedure.

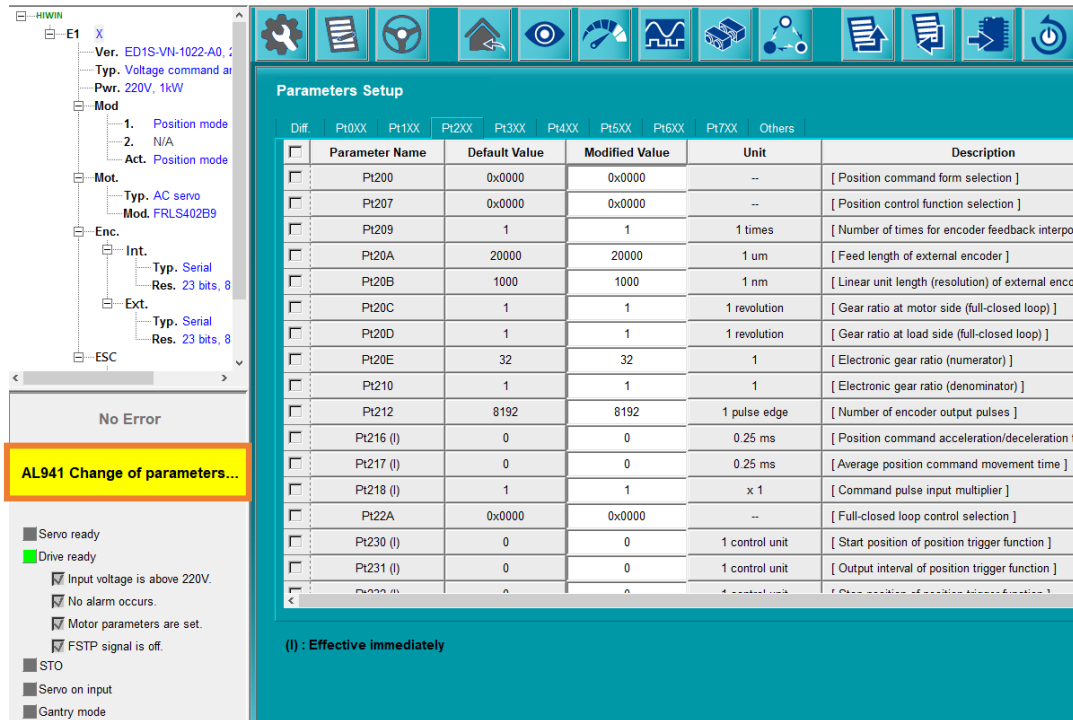

Figure 4.4.2.4.1

4.4.3 Create a servo drive parameters file

4.4.3.1 Brief introduction

The two main functions of servo drive parameters file (*.prm) are creating a new file and loading parameters file. Users can quickly create a servo drive parameters file (*.prm) in the application environment, and load servo drive parameters file (*.prm) in other environments.

Save servo drive parameters file (*.prm)

Users can save servo drive parameters as a servo drive parameters file (*.prm).

Load servo drive parameters file (*.prm)

Users can quickly load the servo drive parameters file (*.prm) created in the past.

4.4.3.2 Save servo drive parameters file (*.prm)

Follow the procedure below to save servo drive parameters file to the assigned path.

1. Click “Save parameters as a file” icon to open “Save prm as a file” window.

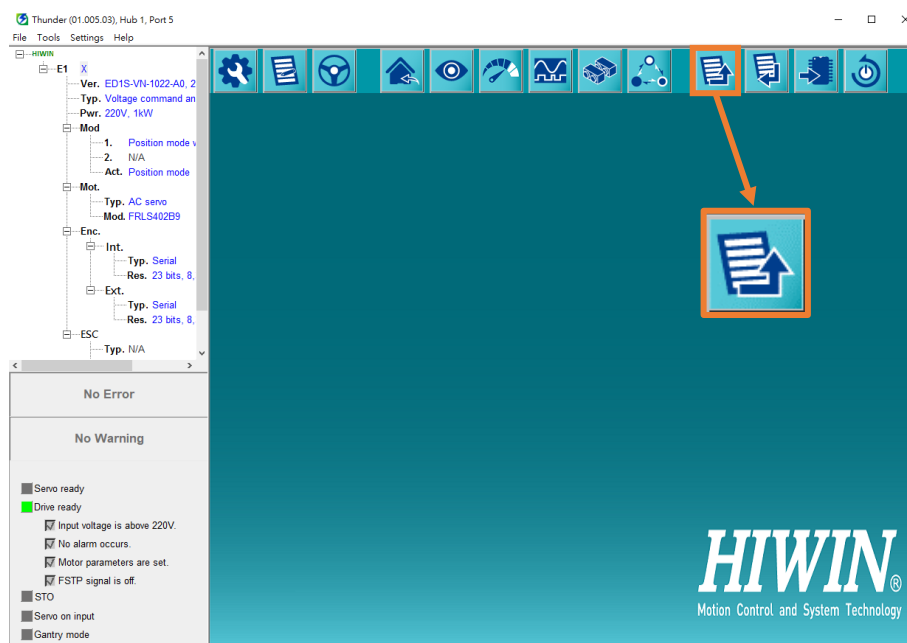

Figure 4.4.3.2.1

2. Click  .

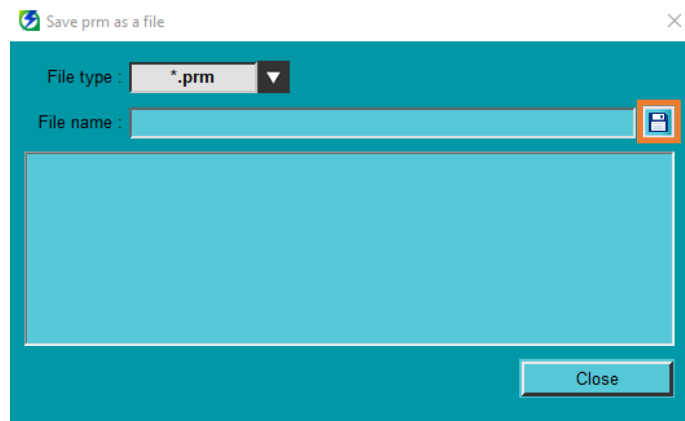

Figure 4.4.3.2.2

3. Key in file name of servo drive parameters file (*.prm), select archive path, and click **Save**.

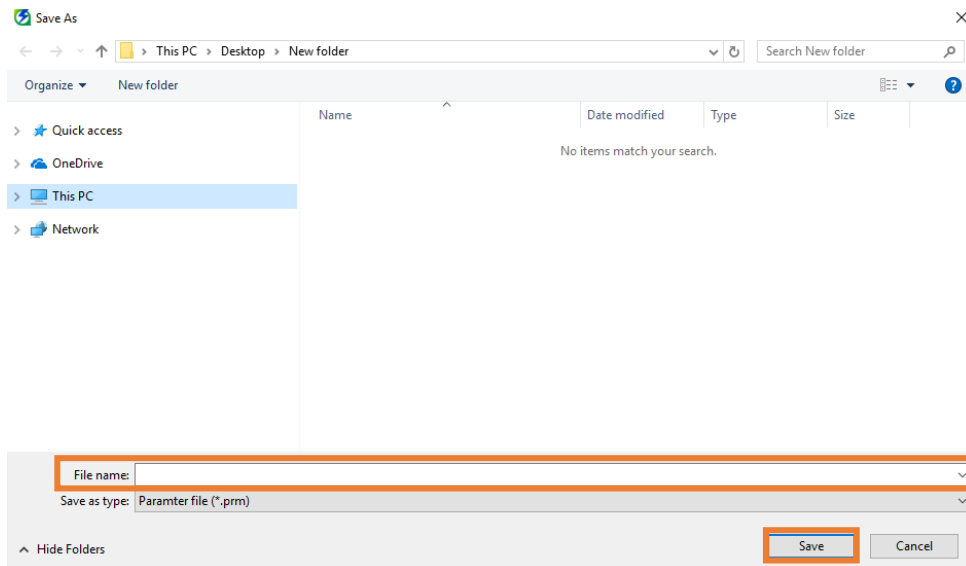

Figure 4.4.3.2.3

4. After ensuring the file is successfully saved, click **Close**.

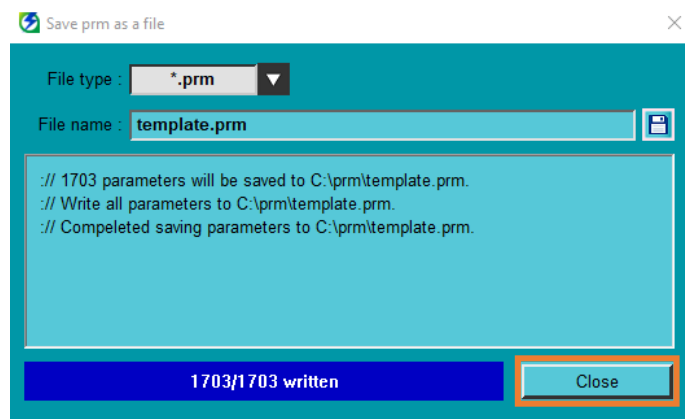

Figure 4.4.3.2.4

4.4.3.3 Load servo drive parameters file (*.prm)



◆ To avoid unexpected actions, ensure the motor is disabled and remains static before execution.

Follow the procedure below to load the created servo drive parameters file to servo drive.

1. Click “Load parameters from file to drive” icon to open “Load prm file” window.

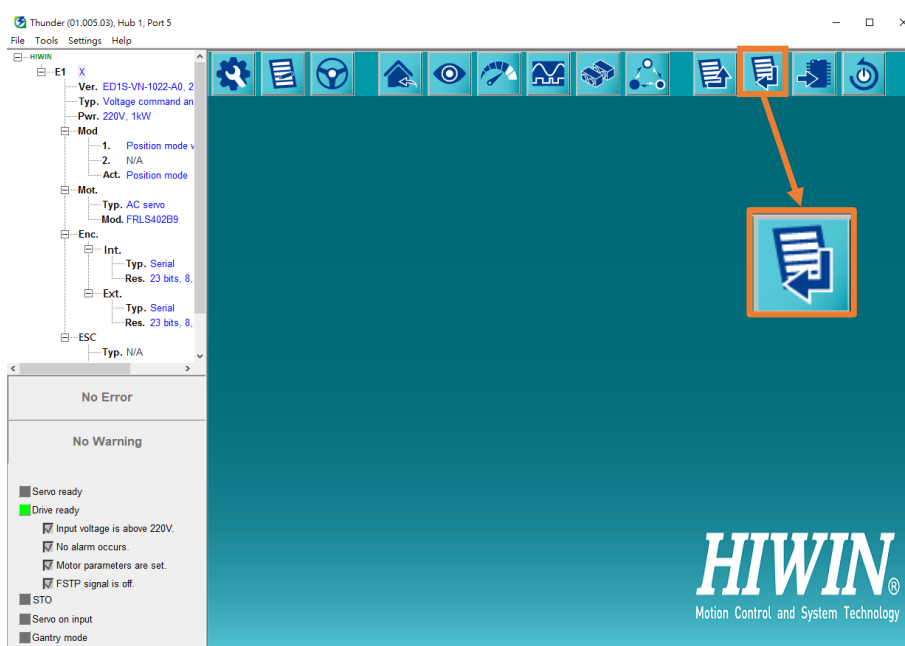

Figure 4.4.3.3.1

2. Click .

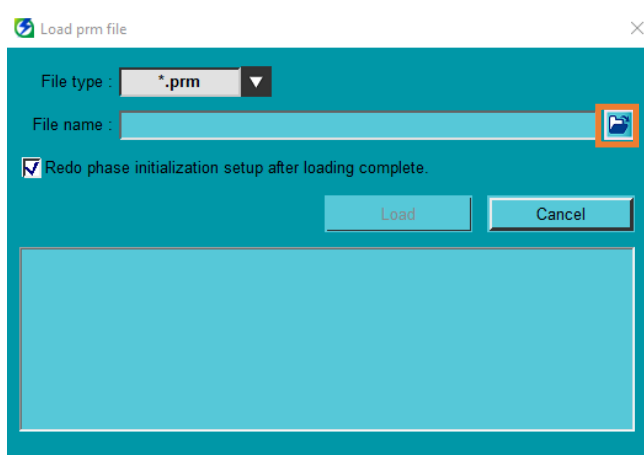

Figure 4.4.3.3.2

3. Select servo drive parameters file (*.prm), and click **Open**.

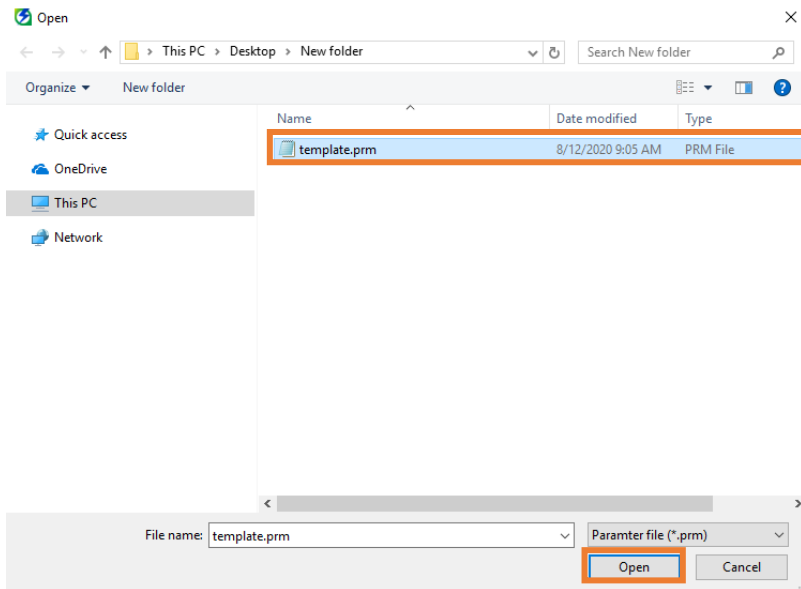

Figure 4.4.3.3.3

4. Click **Load**.

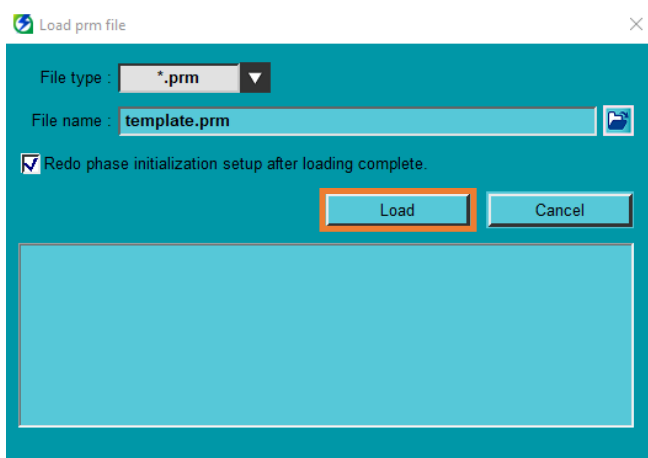

Figure 4.4.3.3.4



Important

If the following items are checked, users can uncheck the default of **Redo phase initialization setup after loading complete**. By doing so, users do not need to redo phase initialization.

- (1) The connected motor model number and encoder resolution are the same as the settings of the parameters.
- (2) The connected motor model number and encoder resolution are the same as the settings of the parameters.
- (3) The installation of stators and rotators are the same as the settings of the parameters.

- After reading the message window and ensuring the file is correct, click **Yes**. Thunder will load the servo drive parameters file (*.prm) and reset servo drive.

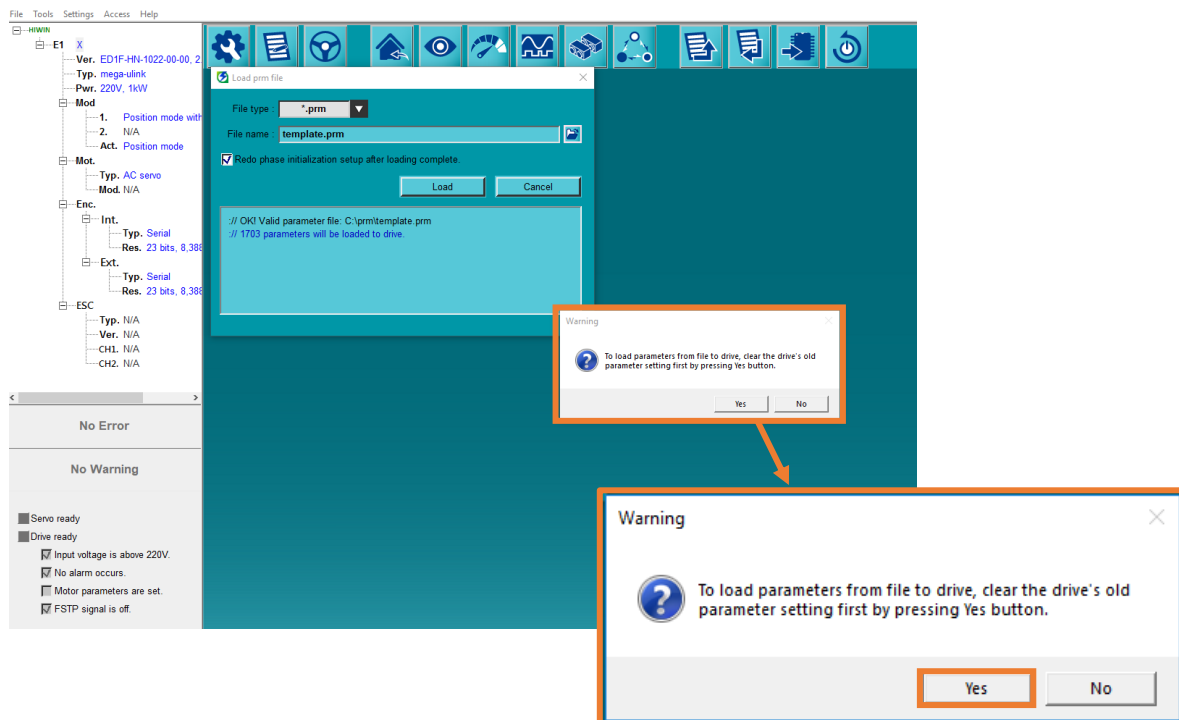

Figure 4.4.3.3.5

- After the servo drive parameters file (*.prm) is successfully loaded, “Load prm file” window will be automatically closed.



Important

- Before loading, Thunder will check if the servo drive model matches the parameters file.
- Thunder can only load the servo drive parameters file created by the same or the older firmware version.

4.4.4 Send the parameters to servo drive

There are two kinds of servo drive parameters, immediately effective and non-immediately effective. To make non-immediately effective parameters be effective, users must send them to servo drive and power cycle servo drive. When the parameters are sent to servo drive, it indicates they are saved to servo drive's memory. Even if users power off the servo drive, the parameters setting will not disappear.

 **DANGER**

◆ To avoid unexpected actions, ensure the motor is disabled and remains static before execution.

Follow the procedure below to send the parameters to servo drive.

1. Click "Save to drive" icon in the toolbar.

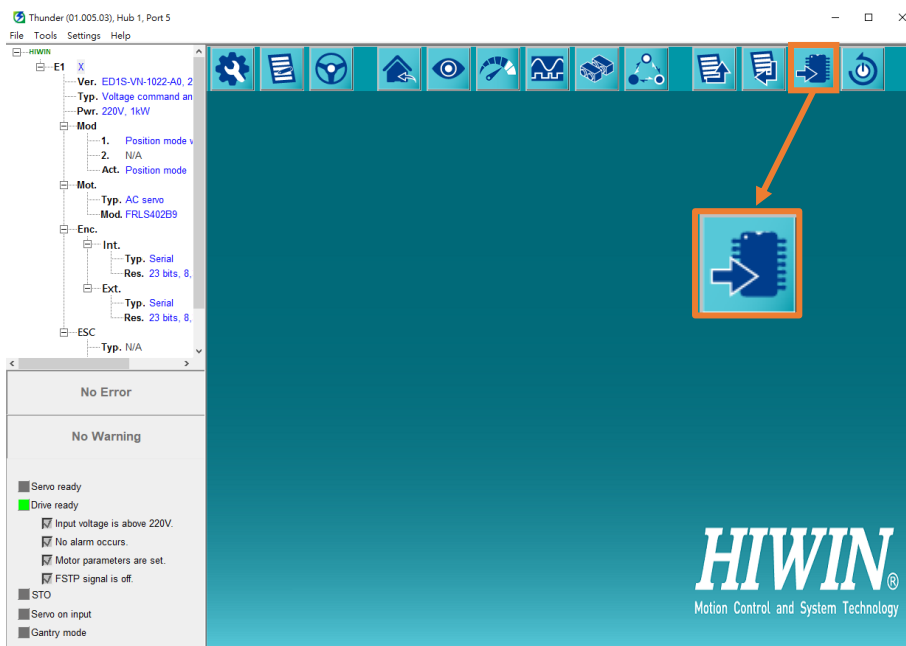

Figure 4.4.4.1

2. Click **Save** to save the parameters data to servo drive's memory. When it is done, the message window will show [Save RAM to flash ended successfully](#).

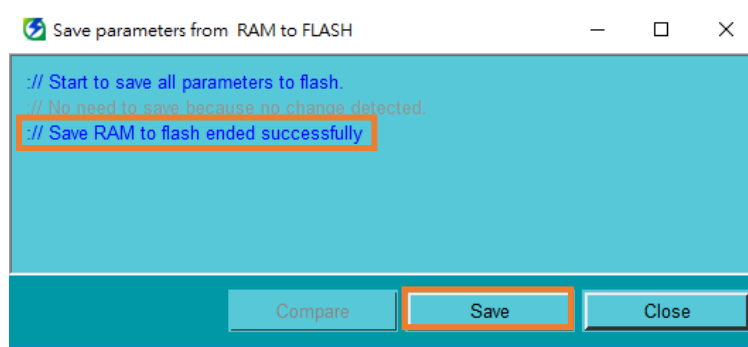

Figure 4.4.4.2

4.4.5 Reset drive

HMI sends commands to reset servo drive. In the process, servo drive will be power cycled. Users do not need to operate power switch to read servo drive parameters again or reset servo drive's alarms or warnings.



Information

- (1) If users do not send the set parameters data to servo drive, all the parameters settings will be lost after the servo drive is reset.
- (2) During the process of resetting servo drive, Thunder will close all the operating pages to avoid users from modifying parameters.
- (3) For Fieldbus servo drive, after servo drive is reset, Controller will automatically hold the mastership and "Reset drive" icon cannot be clicked. Only when the mastership is switched to Thunder, "Reset drive" icon can be clicked.

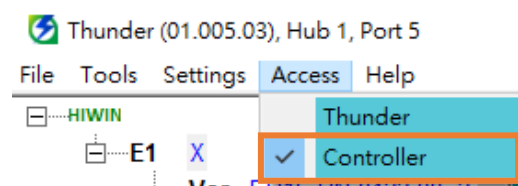

Figure 4.4.5.1

DANGER

◆ To avoid unexpected actions, ensure the motor is disabled and remains static before execution.

Follow the procedure below to reset servo drive.

1. Click "Reset drive" icon in the toolbar.

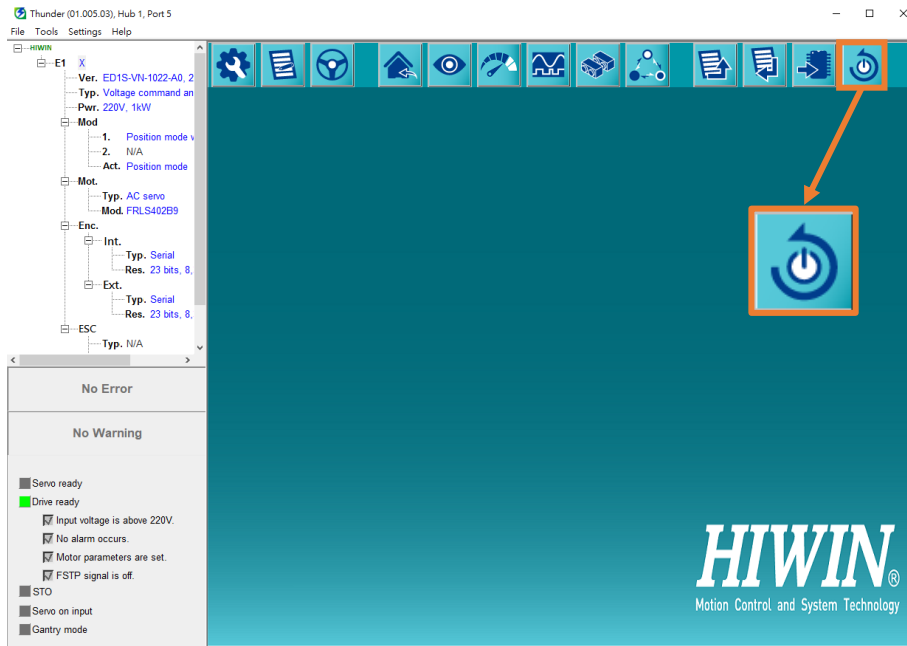

Figure 4.4.5.2

2. Click **Reset** to reset servo drive.

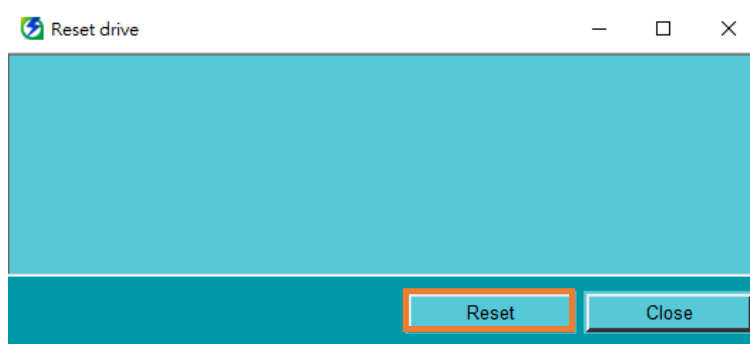

Figure 4.4.5.3

4.4.6 Set to factory default

4.4.6.1 Brief introduction

Set the servo drive to factory default and provide three optional functions of clearing the contents in servo drive's memory.

⚠ DANGER

- ◆ During the execution, the servo drive will be reset. To avoid unexpected actions, ensure the motor is disabled and remains static before execution.

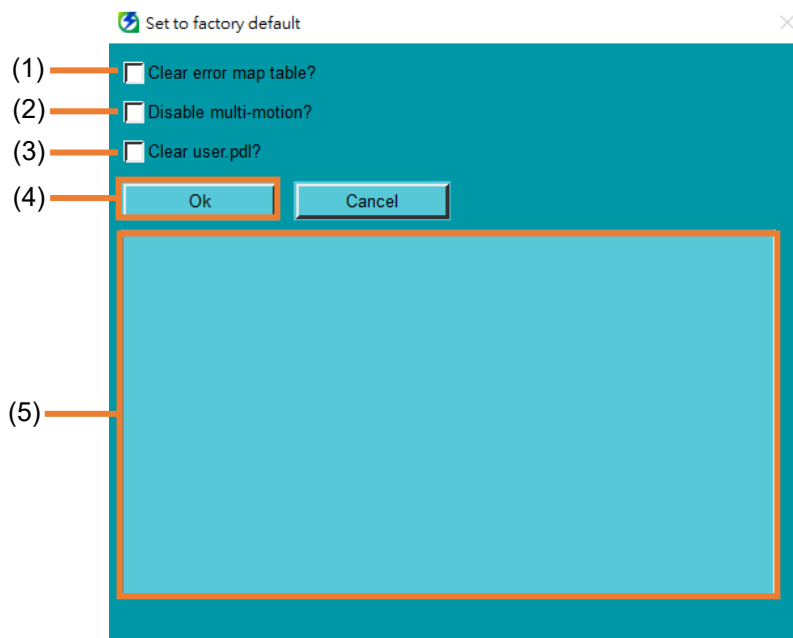

Figure 4.4.6.1.1

Table 4.4.6.1.1

No.	Item	Description	Reference
(1)	Option of error map table	Users can optionally clear the created error map table (section 9.6).	section 4.4.6.3
(2)	Option of multi-motion function	Users can optionally clear and disable the created multi-motion function (section 9.2).	section 4.4.6.4
(3)	Option of PDL	Users can optionally clear the created PDL (section 9.5).	section 4.4.6.5
(4)	Function execution	Restore servo drive parameters to factory default.	section 4.4.6.2
(5)	Message display area	Display the executing process and result.	--

4.4.6.2 Set to factory default

Follow the procedure below to restore servo drive parameters.



The default of **Disable multi-motion function** option is checked.

Information

1. Select **Tools** in the menu bar, and click **Set to factory default**.

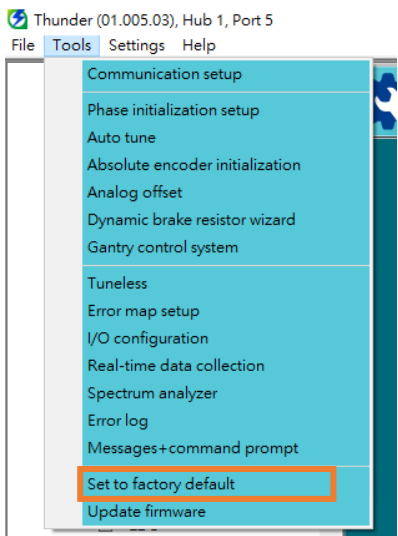

Figure 4.4.6.2.1

2. Uncheck **Disable multi-motion** and click **Ok** to restore servo drive parameters.

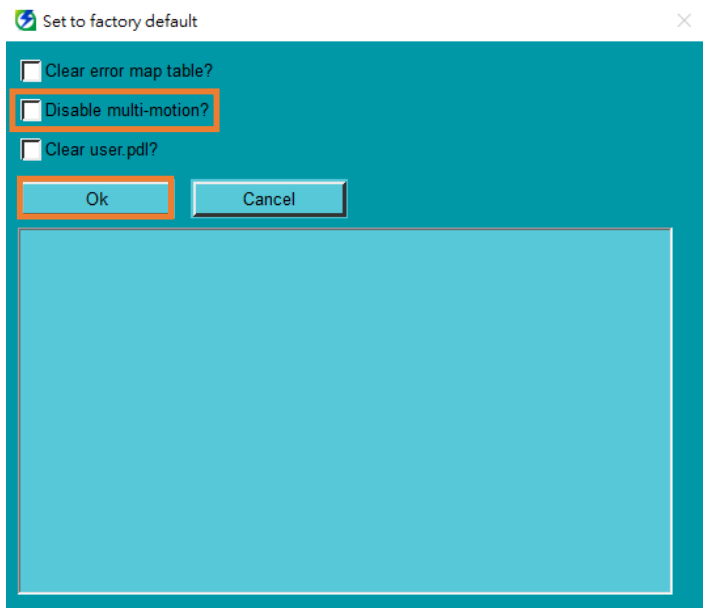

Figure 4.4.6.2.2

4.4.6.3 Clear error map table

Follow the procedure below to clear the error map table existed in servo drive.

1. Select **Tools** in the menu bar, and click **Set to factory default**.

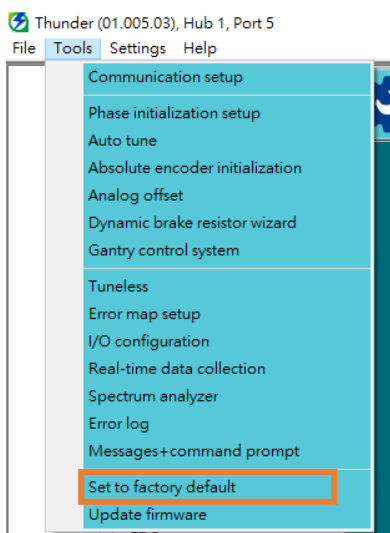

Figure 4.4.6.3.1

2. Check **Clear error map table** and click **Ok** to restore servo drive parameters and clear error map table.

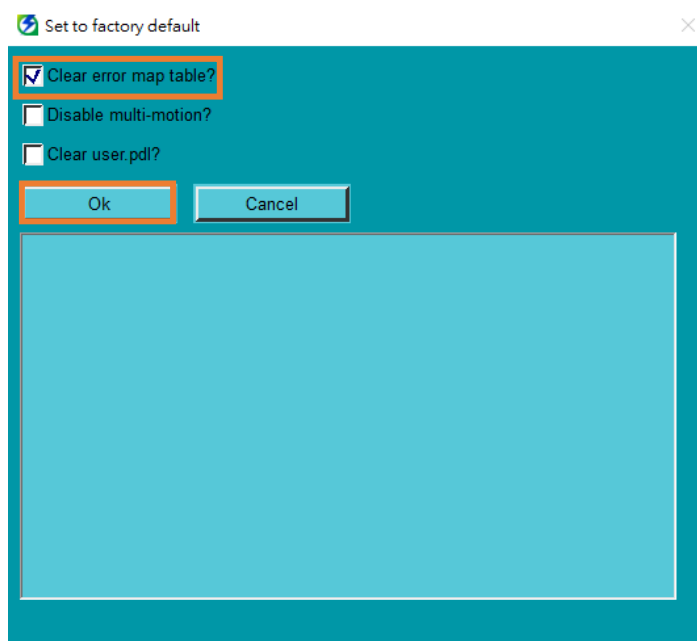

Figure 4.4.6.3.2

4.4.6.4 Disable multi-motion function

Follow the procedure below to clear and disable the multi-motion function existed in servo drive.

1. Select **Tools** in the menu bar, and click **Set to factory default**.

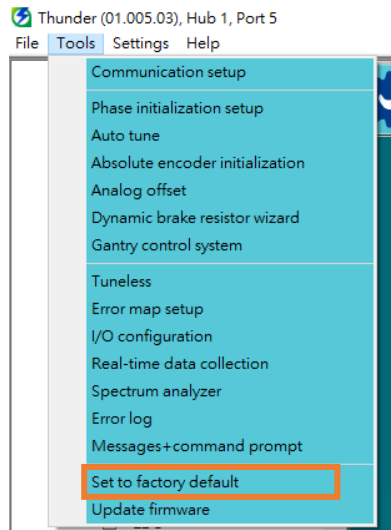

Figure 4.4.6.4.1

2. Click **Ok** to restore servo drive parameters and disable multi-motion function.

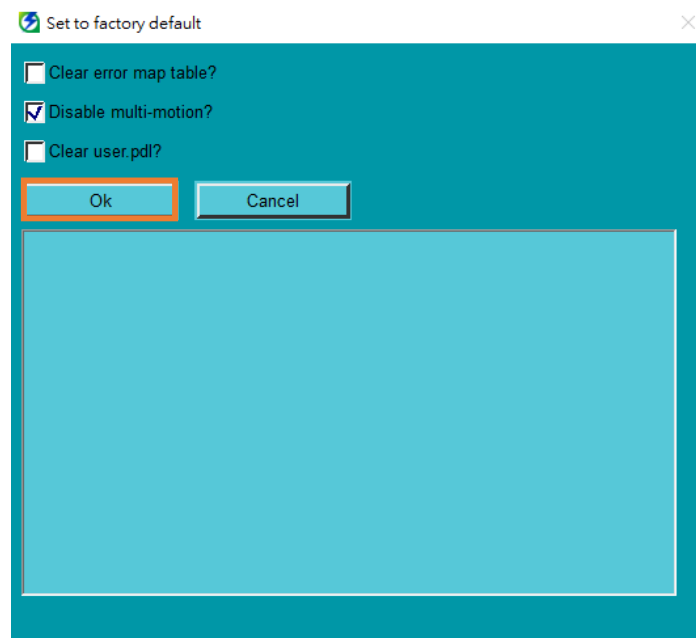

Figure 4.4.6.4.2

4.4.6.5 Clear PDL

Follow the procedure below to clear the user.pdl existed in servo drive.

1. Select **Tools** in the menu bar, and click **Set to factory default**.

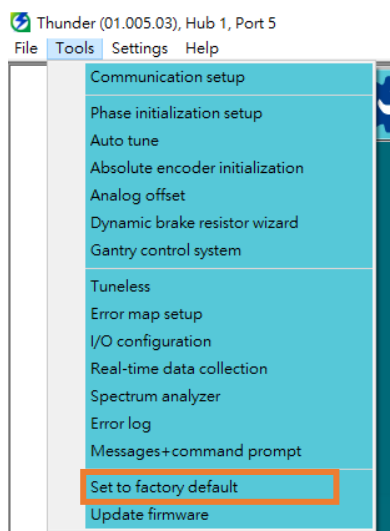

Figure 4.4.6.5.1

2. Check **Clear user.pdl** and click **Ok** to restore servo drive parameters and clear user.pdl.

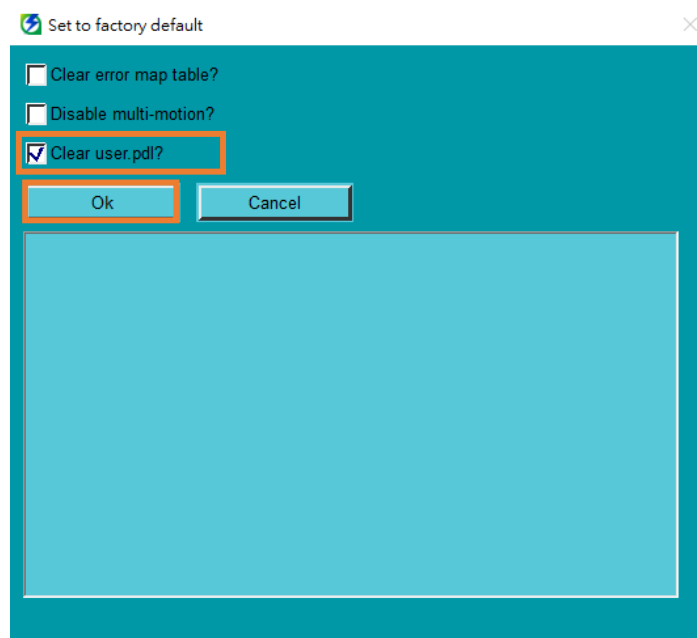

Figure 4.4.6.5.2

4.5 I/O configuration

4.5.1 Brief introduction

Users can configure servo drive's digital input signals and digital output signals.

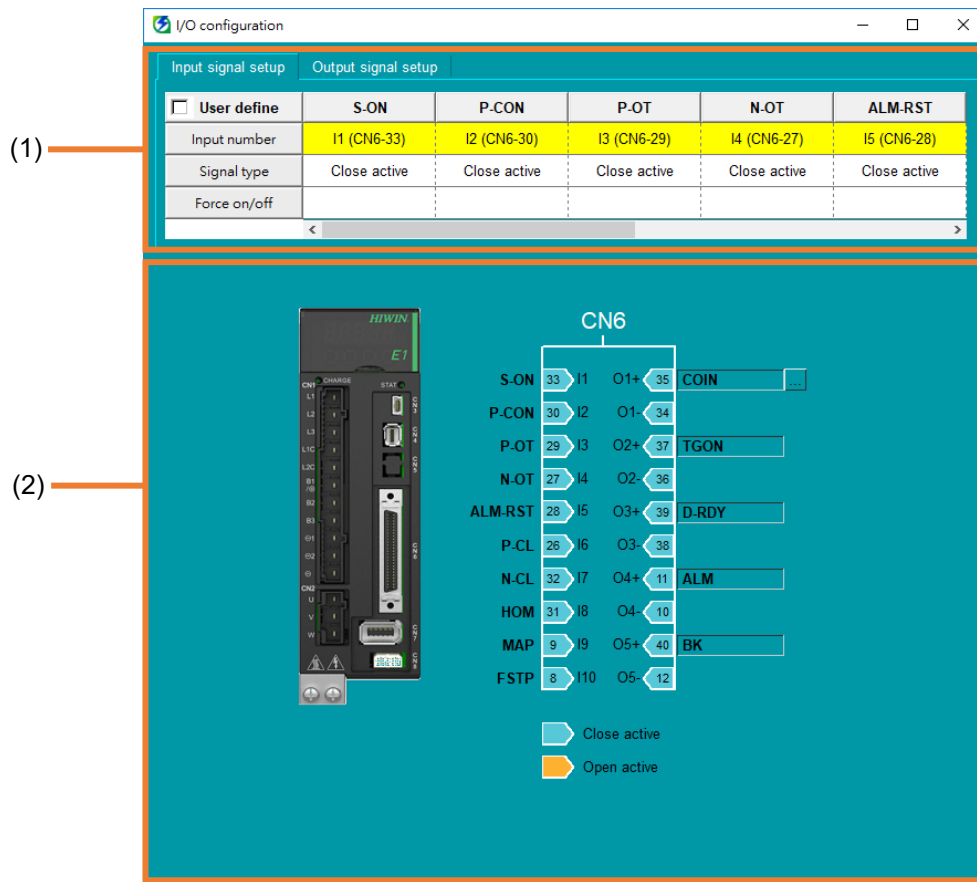

Figure 4.5.1.1

Table 4.5.1.1

No.	Item	Description	Reference
(1)	Digital input tab, digital output tab	Display the configuration and setting of input / output signals. Users can modify the configuration and setting of signals in these two tabs.	section 4.5.2 section 4.5.3
(2)	Display area of digital signal configuration	Users can check the status of digital I/O signal configuration here.	section 4.5.4

4.5.2 Configuration of digital input signals

Each pin of CN6 has the default I/O signal configuration as the servo drive leaves the factory. Users can modify its configuration and signal type. Follow the procedure below to modify configuration of digital input signals.

1. Select **Tools** in the menu bar, and click **I/O configuration** to open “I/O configuration” window.

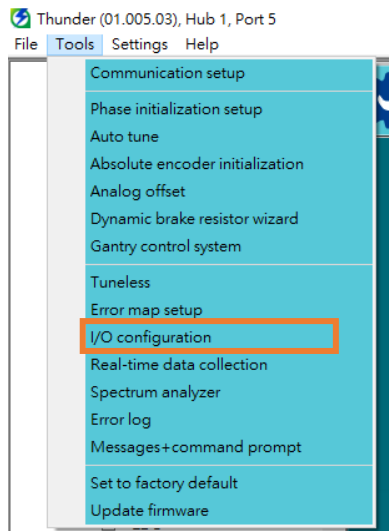

Figure 4.5.2.1

2. Set digital input signal’s signal type: double-click **Signal type** column or click the pin in the diagram. The descriptions are given in the following table. If it is set as “Close active”, the pin color is blue; if it is set as “Open active”, the pin color is orange.

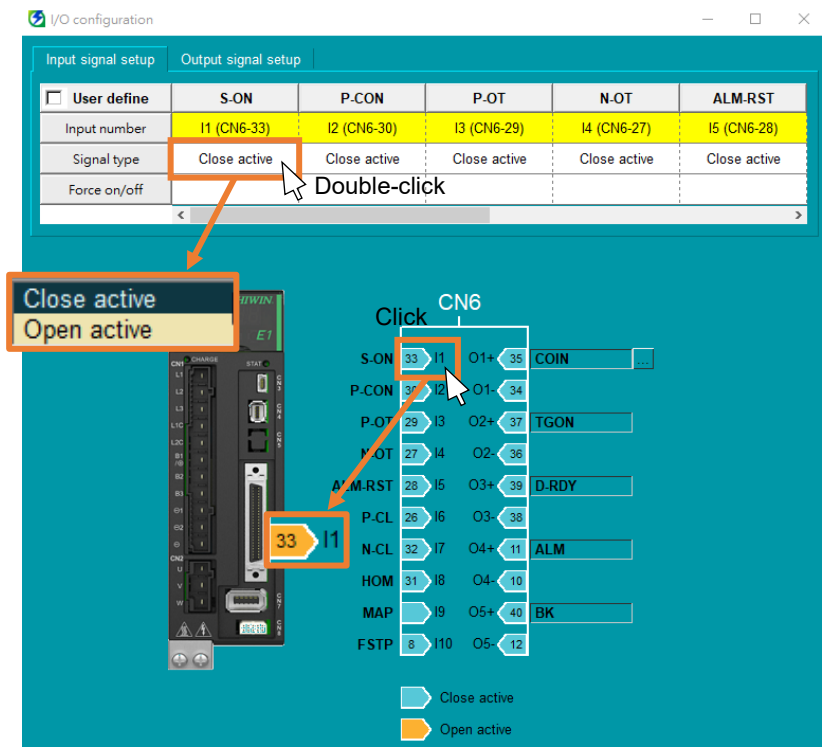

Figure 4.5.2.2

Table 4.5.2.1

Signal type \ Signal	Input	Not input
Close active	Activate digital input	Deactivate digital input
Open active	Deactivate digital input	Activate digital input

3. Check **User define** to customize the digital input signal allocation. Double-click **Input number** column to assign the digital input signal to the pin not in use or set it as “Not configure”. Double-click **Force on/off** column to set the digital input signal as “Force On” or “Force Off”.

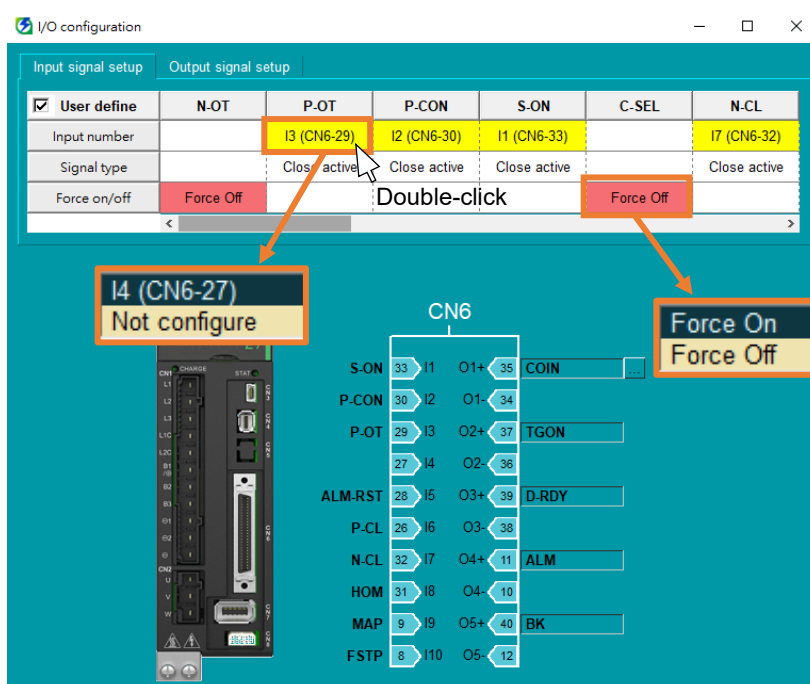

Figure 4.5.2.3



Important

- (1) Standard servo drive provides 10 digital inputs, while Fieldbus servo drive only provides 8 digital inputs.
- (2) Fieldbus servo drive does not support input signal “S-ON” and “P-CON”.



Important

After the modification, click “Save to drive” icon  in the toolbar. The new setting will be effective after users power cycle the servo drive.

4.5.3 Configuration of digital output signals

Each pin of CN6 has the default I/O signal configuration as the servo drive leaves the factory. Users can modify its configuration and signal type. Follow the procedure below to modify configuration of digital output signals.

1. Select **Tools** in the menu bar, and click **I/O configuration** to open “I/O configuration” window.

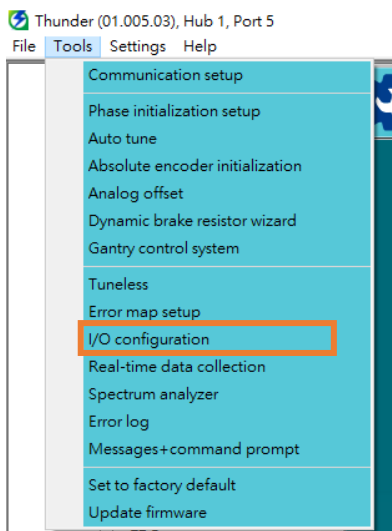

Figure 4.5.3.1

2. Select **Output signal setup** tab.

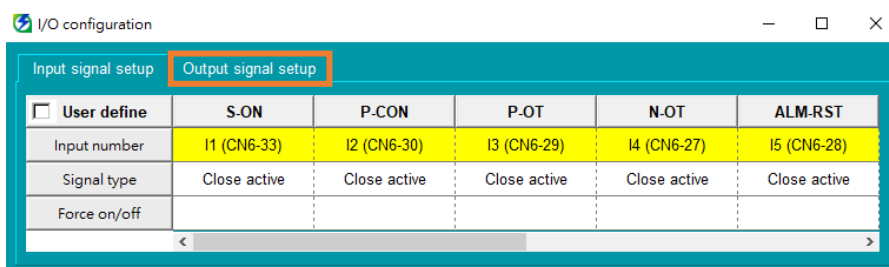

Figure 4.5.3.2

3. Set digital output signal’s signal type: double-click **Signal type** column or click the pin in the diagram. The descriptions are given in the following table. If it is set as “Close active”, the pin color is blue; if it is set as “Open active”, the pin color is orange.

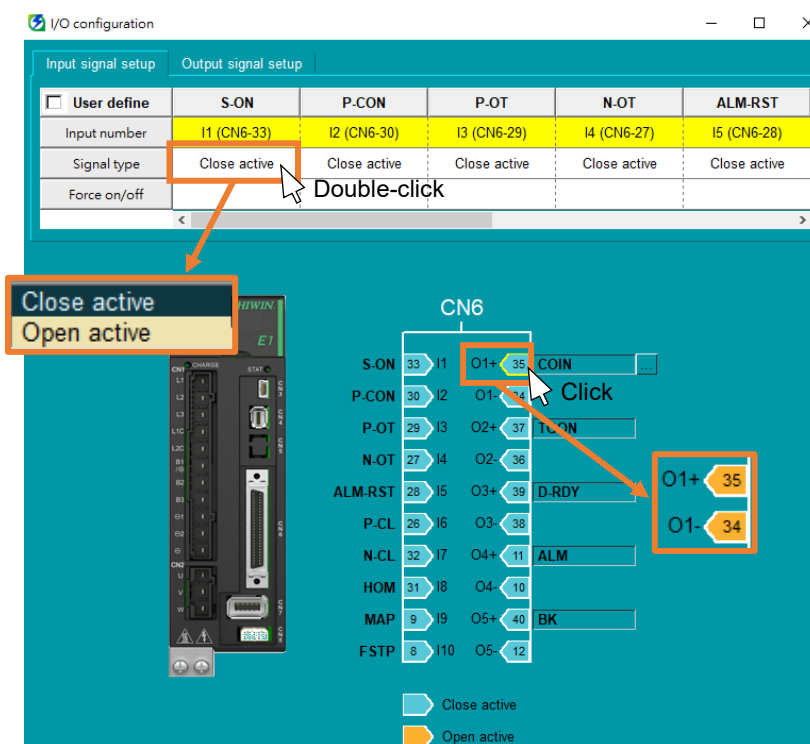

Figure 4.5.3.3

Table 4.5.3.1

Output condition \ Signal type	Satisfied	Not satisfied
Close active	Output digital signal	Do not output digital signal
Open active	Do not output digital signal	Output digital signal



Information

Since the output pins are in pairs (O1+ and O1-, O2+ and O2-...), if users click an output pin, the other pin will also change its color. For example, if user click O1+, O1- will change its color.

- Double-click **Output number** column to assign the digital output signal to any pin or set it as “Not configure”.

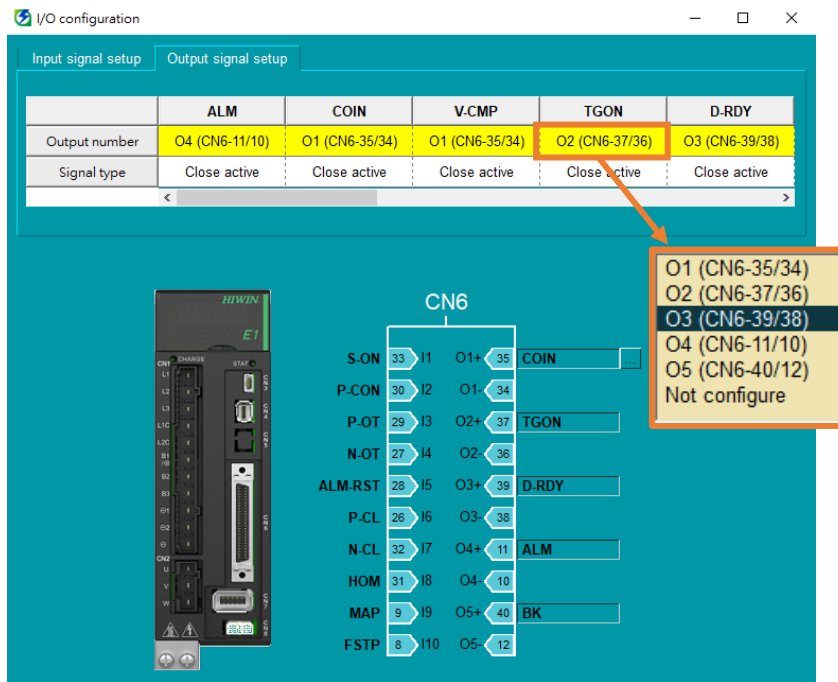

Figure 4.5.3.4



Important

Different control mode has different output signal allocation. If the output signal is not supported by the mode, it will be OFF. Refer to section 8.1.2 in “E1 Series Servo Drive User Manual” for the detailed descriptions of output signal.



Important

After the modification, click “Save to drive” icon  in the toolbar. The new setting will be effective after users power cycle the servo drive.

4.5.4 Check configuration of I/O signals

Users can check the configuration of all I/O signals on each pin of CN6 here. If a single pin is assigned to several digital output signals, click  to see all signals assigned to it.

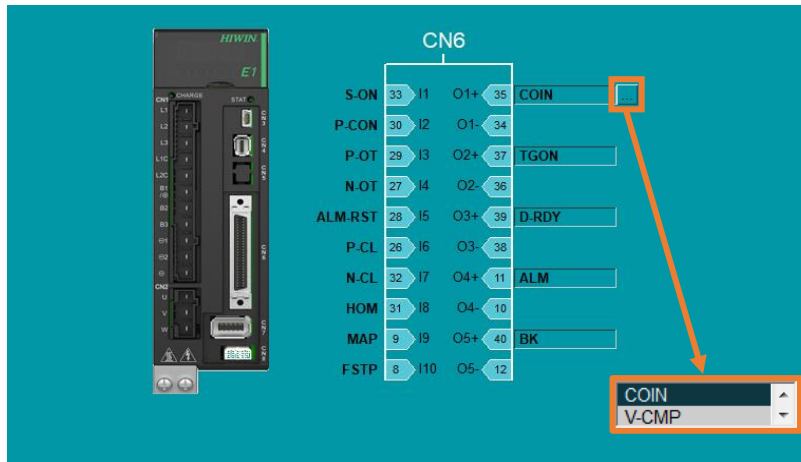

Figure 4.5.4.1



Information

The following figure shows the pin assignment of Fieldbus servo drive.

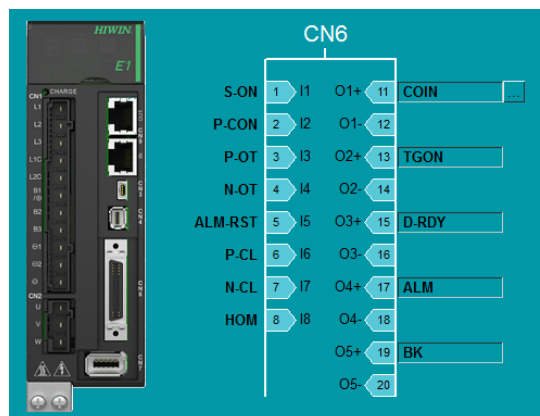

Figure 4.5.4.2

4.6 Phase initialization setup

4.6.1 Brief introduction

Phase initialization is used for servo motor’s electrical angle positioning. There are three steps, force direction test, electrical angle searching and phase initialization completing. These three steps must be executed in sequence.



Important

If HIWIN self-made AC servo motor or DM-RM series is used, there is no need to do phase initialization.



Term

DM-RM series: One of HIWIN’s self-made direct drive motors. B0SN00 is the name of its motor parameters file.

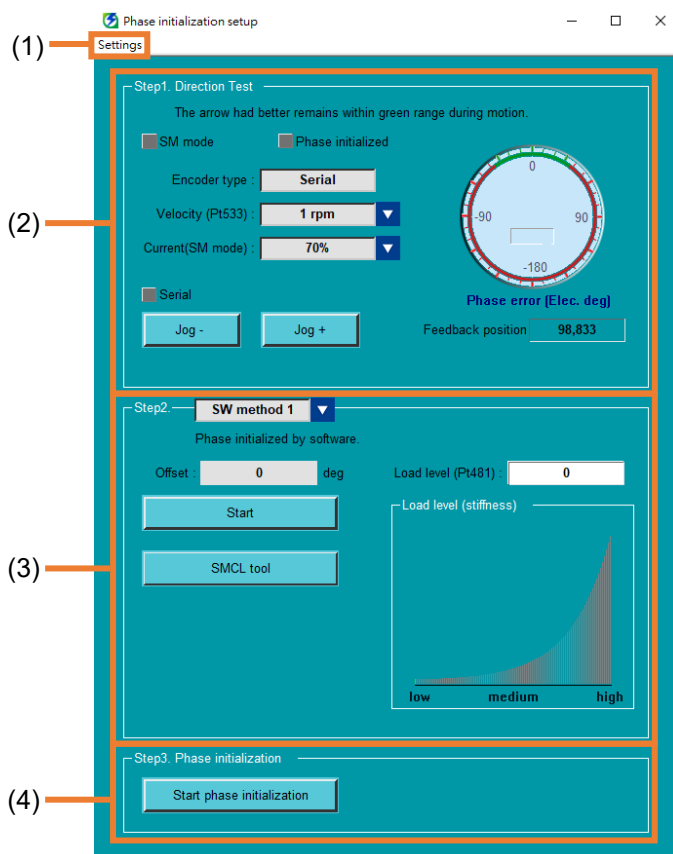

Figure 4.6.1.1

Table 4.6.1.1

No.	Item	Description	Reference
(1)	Option of advanced parameters	Users can set the parameters for direction test.	section 4.6.2
(2)	Direction test	Users can check the consistency of motor's force direction and encoder's feedback direction via direction test.	section 4.6.2
(3)	Electrical angle detection	Users can select the method of phase initialization.	section 4.6.3
(4)	Function execution	Complete phase initialization.	section 4.6.4

4.6.2 Direction test

4.6.2.1 Parameters setup for direction test

Before starting direction test, there are three test parameters for users to set: motor moving velocity, exciting current and motor travel distance. Refer to the following table for the related information.

Table 4.6.2.1.1

Item	Reference
Set motor moving velocity	Motor moving velocity
Set exciting current	Exciting current
Set motor travel distance	Motor travel distance
Start direction test	section 4.6.2.2

■ Motor moving velocity

Follow the procedure below to set motor moving velocity.

1. Select **Tools** in the menu bar, and click **Phase initialization setup**.

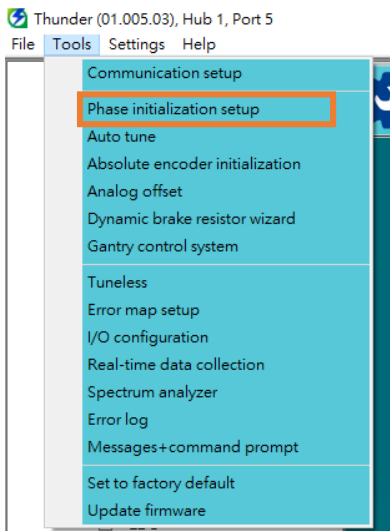

Figure 4.6.2.1.1

2. Velocity option displays in the operating area. The setting range is from 1 rpm to 5 rpm.

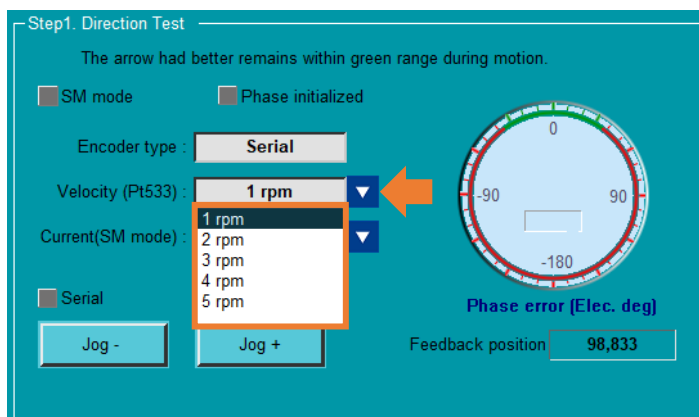

Figure 4.6.2.1.2

■ Exciting current

Exciting current is the required current for the motor to move on SM mode. Follow the procedure below to set exciting current.

1. The default value for exciting current is **70%**. The setting range is from 70% to 200%.

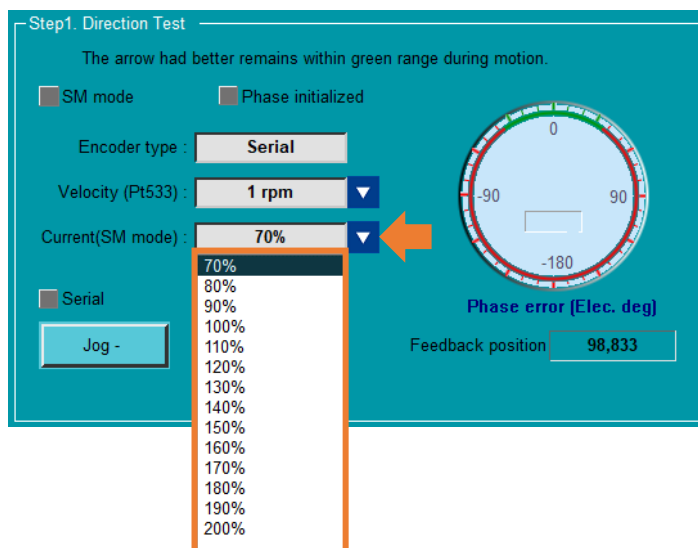

Figure 4.6.2.1.3

2. If exciting current exceeds 70%, a warning will be displayed to remind users.

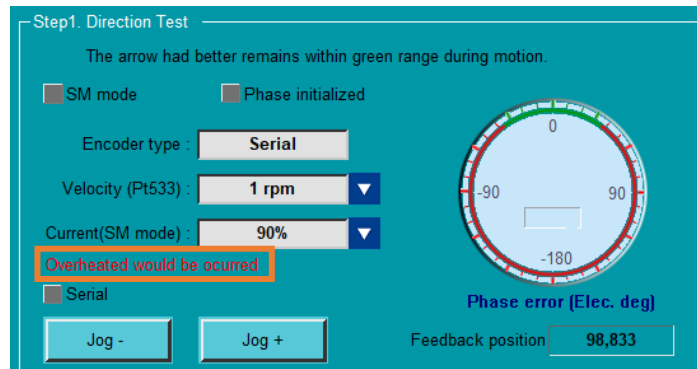

Figure 4.6.2.1.4



Information

- (1) If the load is very heavy, it may require larger current to make the motor move.
- (2) High static friction environment may require larger current to overcome static friction.
- (3) Both the starting moment that static friction becomes dynamic friction and the stopping moment that dynamic friction becomes static friction may make the motor jog. It is not the servo drive's problem.

⚠ WARNING

- ◆ The exciting current should not be too large (the value which can make the motor move is enough). When the motor is enabled on SM mode, the servo drive will continuously output the current set by users. Therefore, the time should not be too long, or it may make the motor overheat or burn.

■ Motor travel distance

Motor travel distance is the minimum distance for the motor to move during the test moving process. If the travel distance is too short due to mechanical reason, lower motor travel distance. Follow the procedure below to set motor travel distance.

1. Select **Settings** in the menu bar, and click **Advanced direction test** to open “Advanced direction test setting” window.

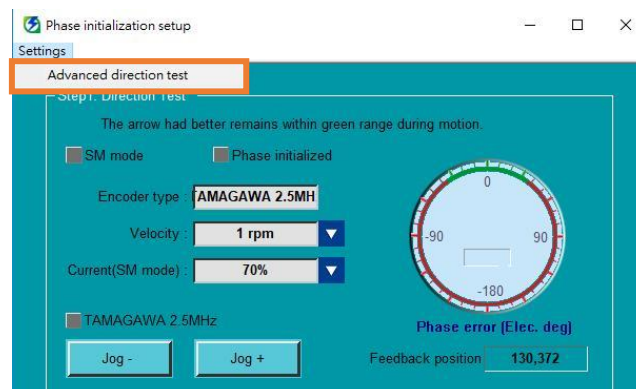

Figure 4.6.2.1.5

- The default value for travel distance is **Long**. There are three kinds of travel distance for users to select.

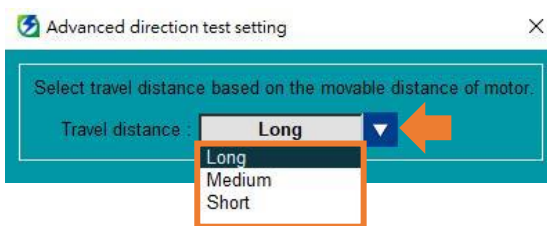

Figure 4.6.2.1.6

4.6.2.2 Start direction test

Encoders can be divided into two categories, single-signal encoder and double-signal encoder. The difference is that double-signal encoder must switch the encoder feedback sources to do the test twice. To ensure the safety of motor, the motor will automatically be disabled in five seconds when the force test is done. Refer to the following table for the related information.



Term

- Single-signal encoder: There is only one set of feedback signals on the same encoder. The type of feedback signal can be digital, analog and serial.
- Double-signal encoder: There are two sets of feedback signals on the same encoder. Users can use one of the sets or use two sets at the same time. The type of feedback signal is serial + incremental (sin/cos).

Table 4.6.2.2.1

Item	Reference
Single-signal encoder	Single-signal encoder test
Double-signal encoder	Double-signal encoder test

■ Single-signal encoder test

- Select **Tools** in the menu bar, and click **Phase initialization setup**.

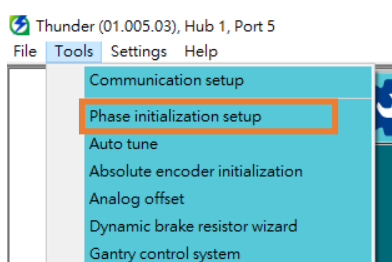

Figure 4.6.2.2.1

2. Click **Jog+** and **Jog-** to move the motor for direction test.

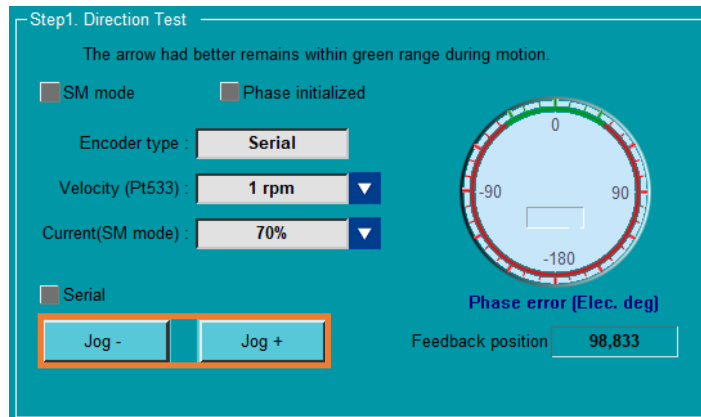

Figure 4.6.2.2.2

3. During the motor moving process, observe the right-side Phase error (Elec. deg) pointer. Wait until the pointer converges to a specific position, “Feedback detect ok” appears and the light lights up in green.

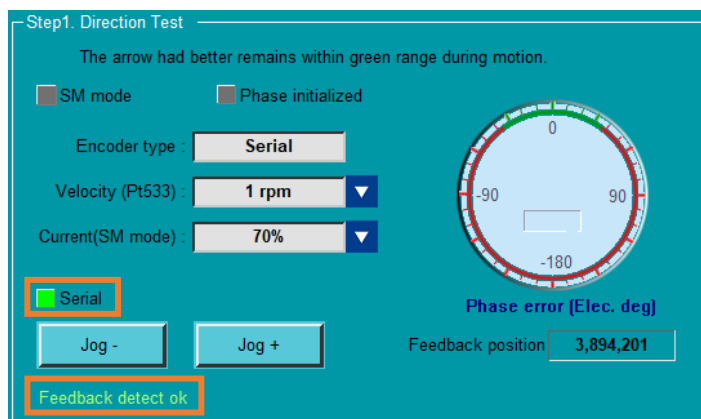

Figure 4.6.2.2.3



Information

If the Phase error (Elec. deg) pointer cannot converge, release **Jog+** / **Jog-** first, and hold **Jog+** / **Jog-** to do the test again.

■ Double-signal encoder test

1. Select **Tools** in the menu bar, and click **Phase initialization setup**.

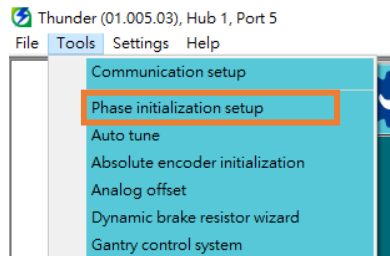

Figure 4.6.2.2.4

2. The default of encoder type is incremental encoder (sin/cos). Click **Jog+** and **Jog-** to move the motor for direction test.

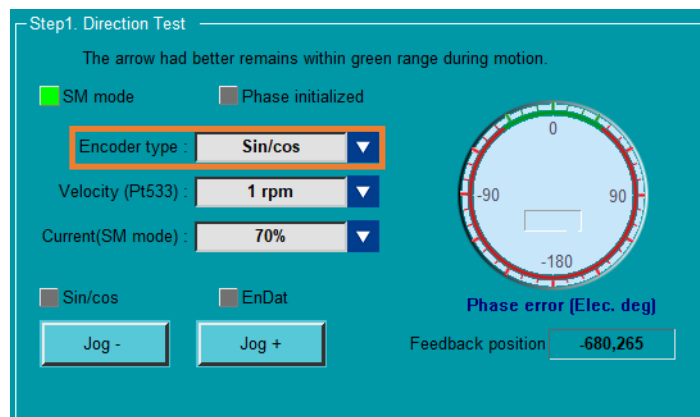

Figure 4.6.2.2.5

3. During the motor moving process, observe the right-side Phase error (Elec. deg) pointer. Wait until the pointer converges to a specific position, "Feedback detect ok" appears and the light lights up in green.

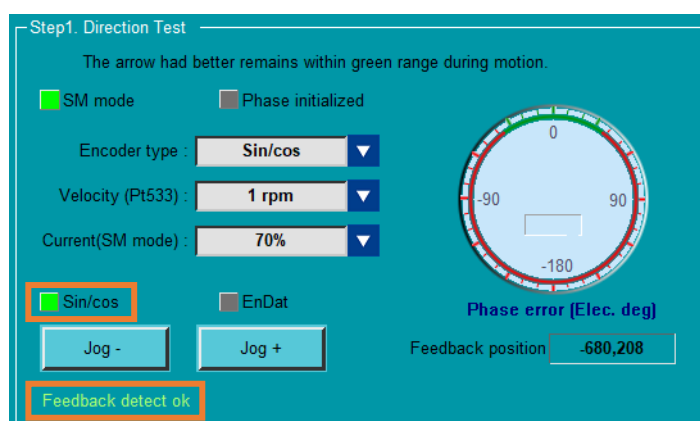

Figure 4.6.2.2.6



If the Phase error (Elec. deg) pointer cannot converge, release **Jog+** / **Jog-** first, and hold **Jog+** / **Jog-** to do the test again.

Information

4. Select **Encoder type** to switch to serial encoder (EnDat). Click **Jog+** and **Jog-** to move the motor for direction test.

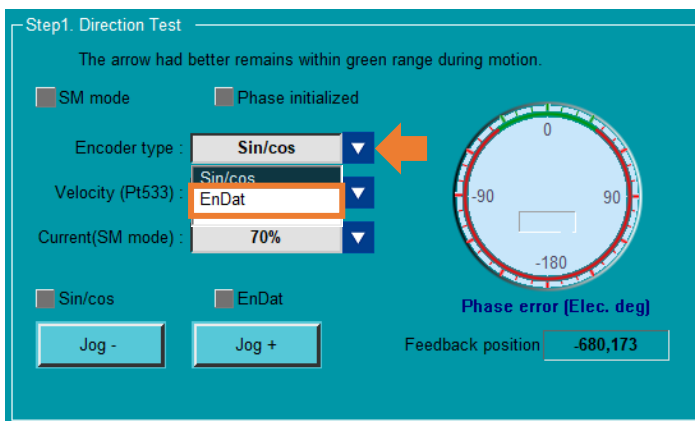

Figure 4.6.2.2.7

5. During the motor moving process, observe the right-side Phase error (Elec. deg) pointer. Wait until the pointer converges to a specific position, “Feedback detect ok” appears and the light lights up in green.

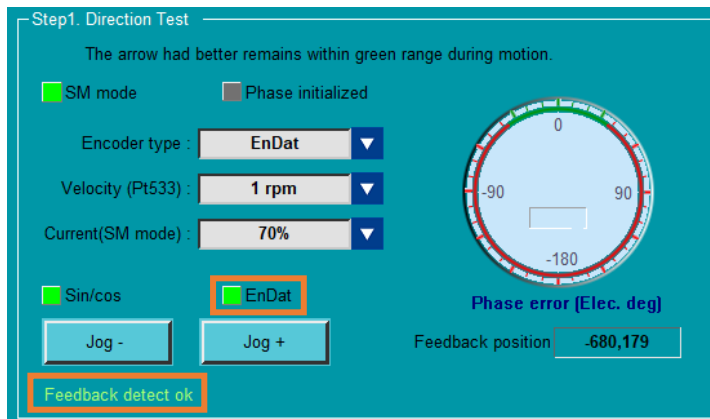

Figure 4.6.2.2.8

4.6.3 Phase initialization function

After direction test is done, users can select one phase initialization method to detect servo motor's electrical angle. Refer to the following table for the related information.

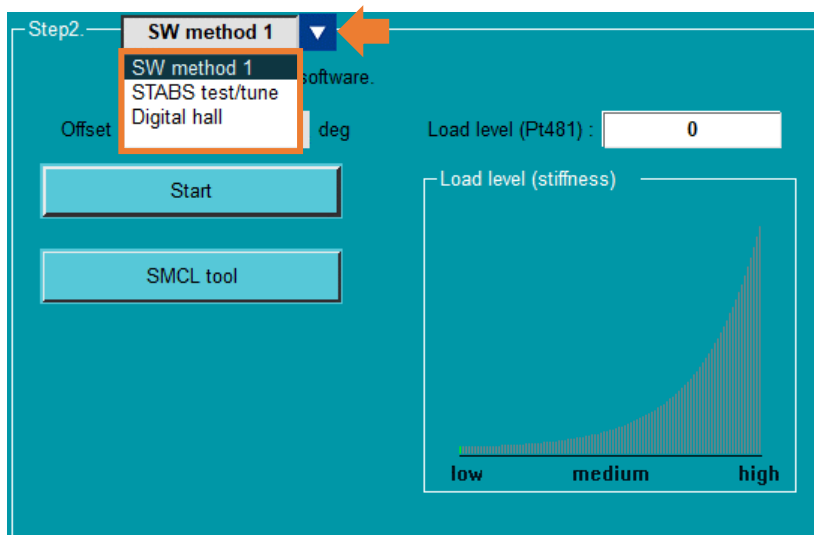

Figure 4.6.3.1

Table 4.6.3.1

Item	Reference
Software method 1's phase initialization	section 4.6.3.1
Serial encoder's phase initialization	section 4.6.3.2
Digital hall sensor's phase initialization	section 4.6.3.3

4.6.3.1 SW method 1

It is a built-in phase initialization function of servo drive. With a subtle displacement of motor, the correct electrical angle can be successfully found.

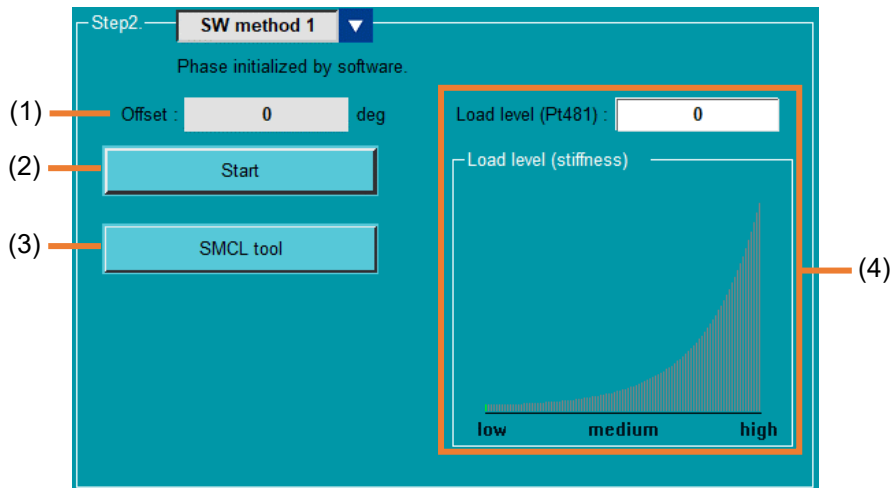

Figure 4.6.3.1.1

Table 4.6.3.1.1

No.	Item	Description
(1)	Electrical angle's offset	Display the test result of starting SW method 1.
(2)	Start SW method 1	Start SW method 1.
(3)	SMCL tool	Check the condition of load convergence with SMCL tool.
(4)	Load level	Set load level.

Follow the procedure below to execute SW method 1.

1. Click **Start** three times, observe the differences of offset value among these three times, and ensure they do not exceed 5 deg. For example, 162.7 deg, 161.3 deg and 163.1 deg.

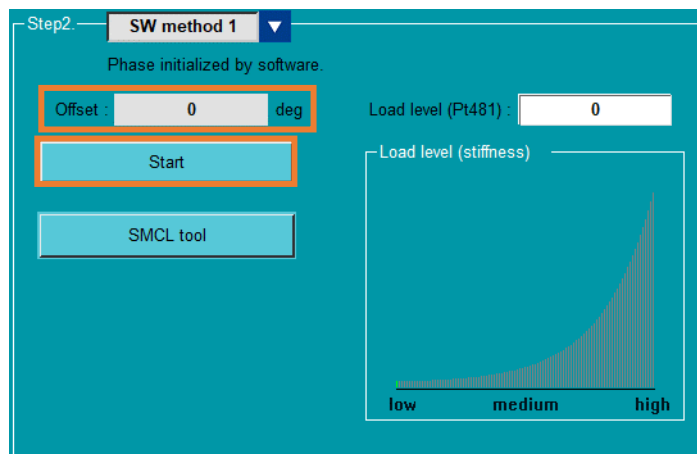

Figure 4.6.3.1.2

- Open **SMCL tool**, click **Start**, and observe electrical angle's position error. If it cannot converge to close to 0 within one second, the gain is not ideal. Please adjust load level.

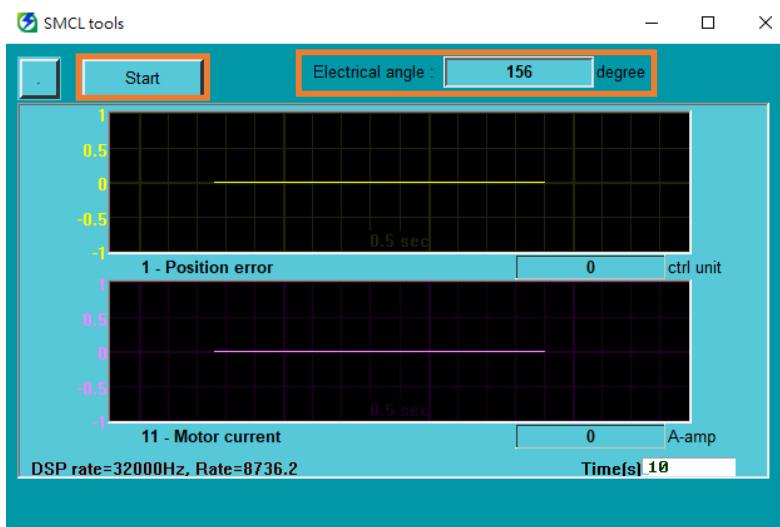

Figure 4.6.3.1.3

4.6.3.2 STABS test/tune

It is a built-in phase initialization function of servo drive, which uses **serial** encoder to stably complete phase initialization.

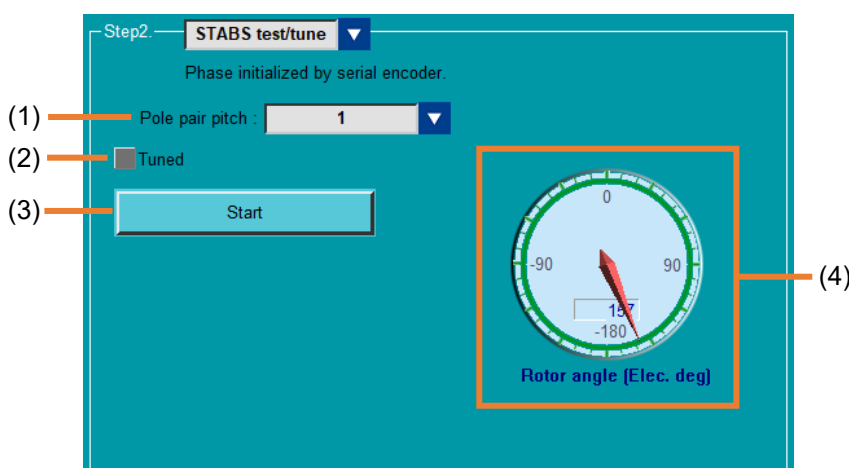

Figure 4.6.3.2.1

Table 4.6.3.2.1

No.	Item	Description
(1)	Set pole pair pitch	Set the minimum distance for the motor to move.
(2)	Test result of STABS tune	Display the test result of STABS tune. If it lights up in green, the tuning is done.

(3)	Start STABS tune	Execute STABS tune.
(4)	Display electrical angle	Display the commands and the feedback electrical angle in the test process.

Follow the procedure below to execute STABS tune.

After selecting **STABS test/tune** in Step2. block, select the range of pole pair pitch and click **Start**. Wait until **Tuned** lights up in green.

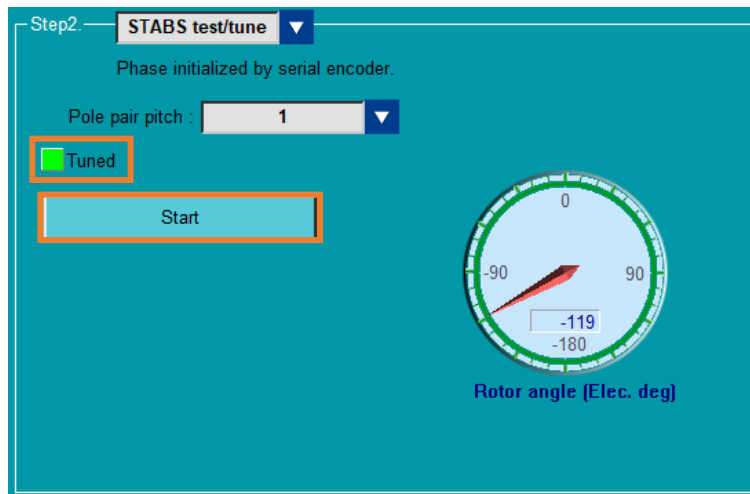

Figure 4.6.3.2.2

4.6.3.3 Digital hall

This method uses hall sensor and rotor's electrical angle to stably complete phase initialization.



Important

If the hall sensor's information has been included in motor setup, Digital hall will be automatically completed in phase initialization setting page, so users can skip this step.

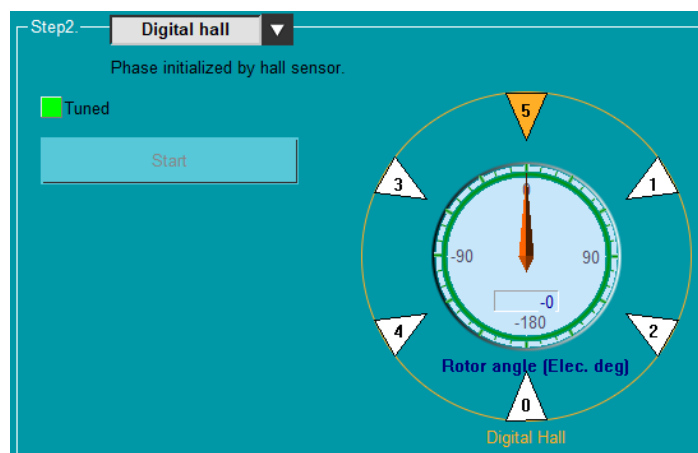

Figure 4.6.3.3.1

Follow the procedure below to execute Digital hall tune.

1. After selecting **Digital hall** in Step2. block, click **Start**.

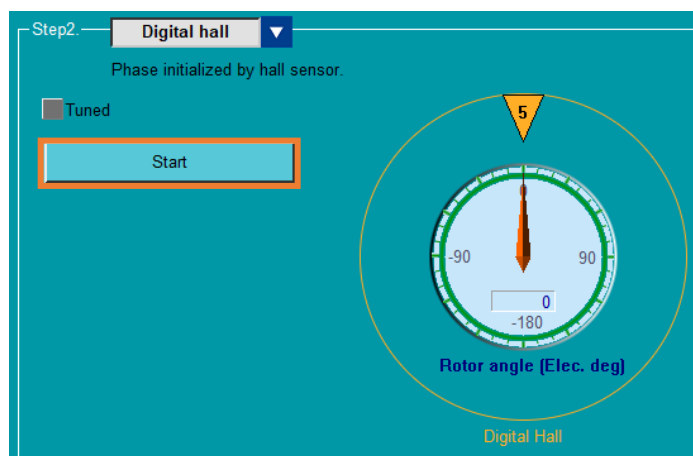

Figure 4.6.3.3.2

2. When the six phase sections are done, **Tuned** will light up in green.

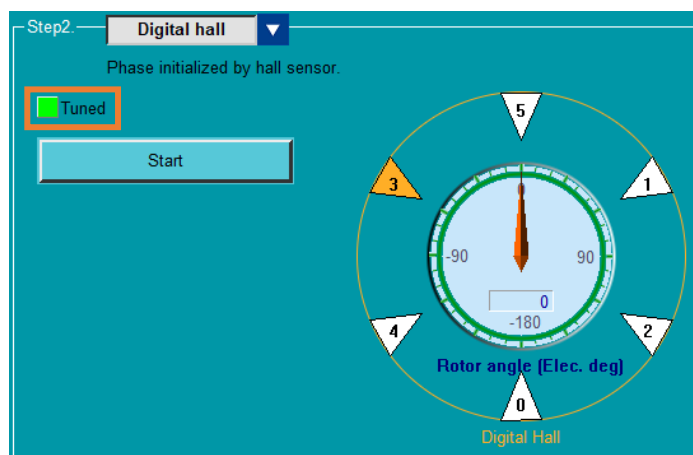

Figure 4.6.3.3.3

4.6.4 Start phase initialization

To execute this step, users must finish force detection test in Step1. block and phase initialization function in Step2. block. Follow the procedure below to start phase initialization.

1. Click **Start phase initialization**.



Figure 4.6.4.1

2. If **Phase initialized** in Step1. block lights up in green, phase initialization succeeds.

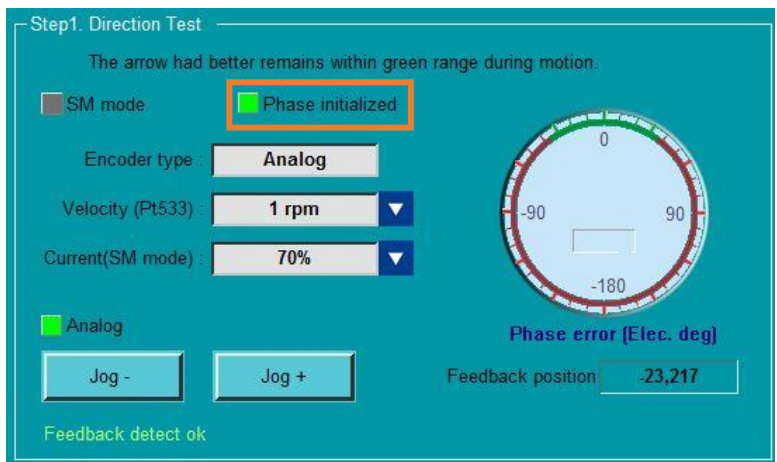

Figure 4.6.4.2

(This page is intentionally left blank.)

5. Perform Test Run

5.	Perform Test Run	5-1
5.1	Brief introduction	5-2
5.2	Test Run.....	5-3
5.2.1	Brief introduction	5-3
5.2.2	Position mode	5-3
5.2.3	Velocity mode.....	5-8
5.3	Homing Operation.....	5-11

5.1 Brief introduction

When servo drive configuration is done, users can test motor's performance with test run function, and decide home position with homing function.



Information

- (1) Before test run, complete **Servo Drive Configuration** first and ensure servo drive's status is at "Servo ready" state. Refer to section 7.4 in "E1 Series Servo Drive User Manual" for the related inspections.
- (2) As for troubleshooting, refer to section 13.4 in "E1 Series Servo Drive User Manual".
- (3) For some servo motors, phase initialization must be done before test run. Refer to section 4.6 for detailed descriptions.



Information

When emergency happens, such as motor out of control, press **F12** on the keyboard to activate emergency stop function. A message window will pop up, and the motor will be disabled.

Read the message window and click **OK**. The things mentioned in the window will be executed.

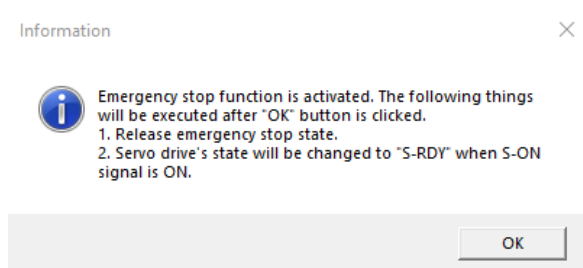

Figure 5.1.1

Test Run

Users can test motor's performance in test run page by position mode or velocity mode. These two motion modes will be introduced in this section.

Homing Operation

Users can define home position or absolute coordinate based on the condition of external equipment.

5.2 Test Run

5.2.1 Brief introduction

When motor setup is done, users can perform performance test in test run page. This page provides two ways, position mode and velocity mode. These two motion modes will be introduced in this section.



Information

For some servo motors, phase initialization must be done before test run. Refer to section 4.6 for detailed descriptions.

Position mode

This mode provides motor parameters, motion test and status observation related to position control.

Velocity mode

This mode provides motor parameters, motion test and status observation related to velocity control.

5.2.2 Position mode

Users can perform position mode test to observe motor's performance. After ensuring the servo drive is ready, follow the procedure below to execute position mode test.

1. Click "Open Test Run" icon in the toolbar to open "Test Run" window.

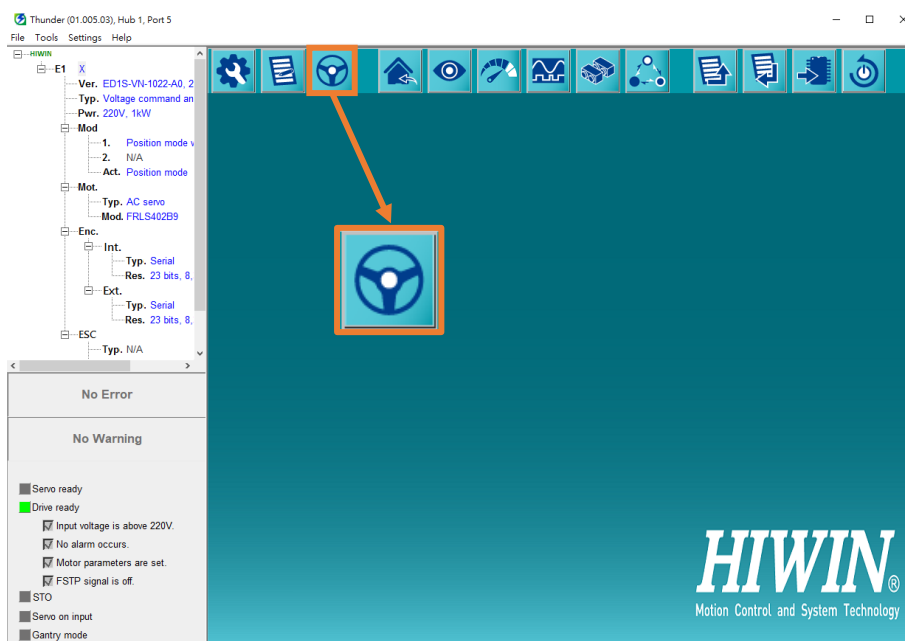

Figure 5.2.2.1

2. Set parameters for position mode test.

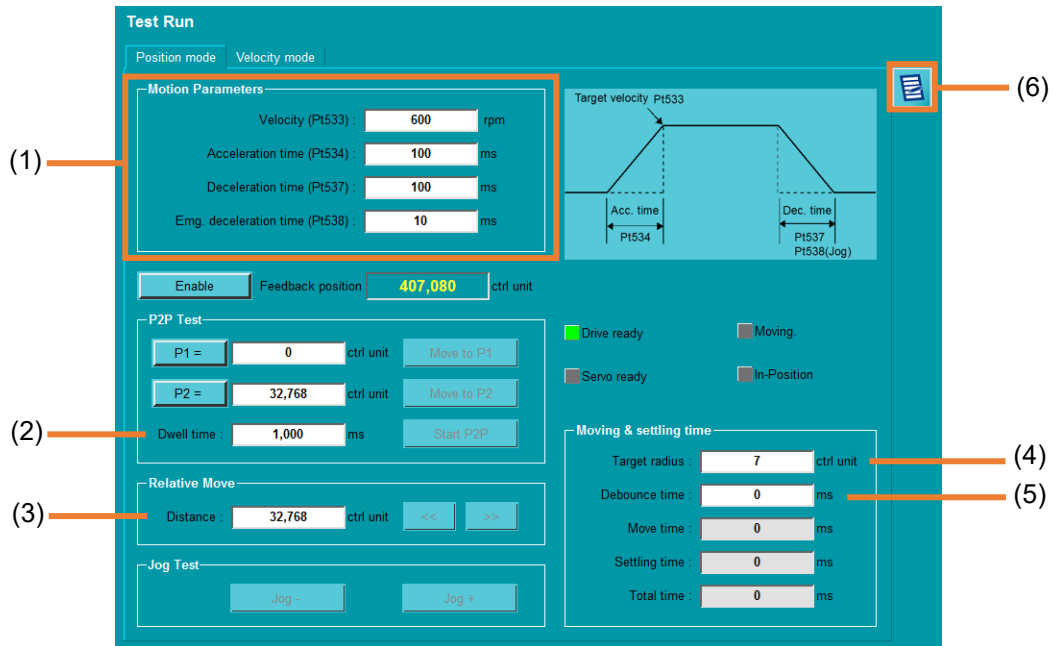

Figure 5.2.2.2

Table 5.2.2.1

No.	Item	Description	Reference
(1)	Motion parameters	Velocity: program jog velocity ◆ Rotary motor rpm (Pt533) ◆ Linear motor mm/s (Pt585) Acceleration time: Program jog acceleration time (Pt534) Deceleration time: Program jog deceleration time (Pt537) Emg. deceleration time: Program jog emergency deceleration time (Pt538)	section 8.7.1 in "E1 Series Servo Drive User Manual"
(2)	Dwell time	Set the waiting time after the previous command is sent and before the next command is sent (Pt535).	section 8.7.1 in "E1 Series Servo Drive User Manual"
(3)	Relative move	Set the distance of relative move (Pt539).	--
(4)	Target radius	Set positioning completion width (Pt522).	section 8.4.4 in "E1 Series Servo Drive User Manual"
(5)	Debounce time	Set debounce time (Pt523).	section 8.4.4 in "E1 Series Servo Drive User Manual"
(6)	Parameters setup	Open Parameters Setup window.	section 4.4



Important

In position mode test, the software will automatically switch to **internal position mode**. Refer to section 4.3.5 for the detailed descriptions of control mode.

3. Observe the status and values in position mode test.

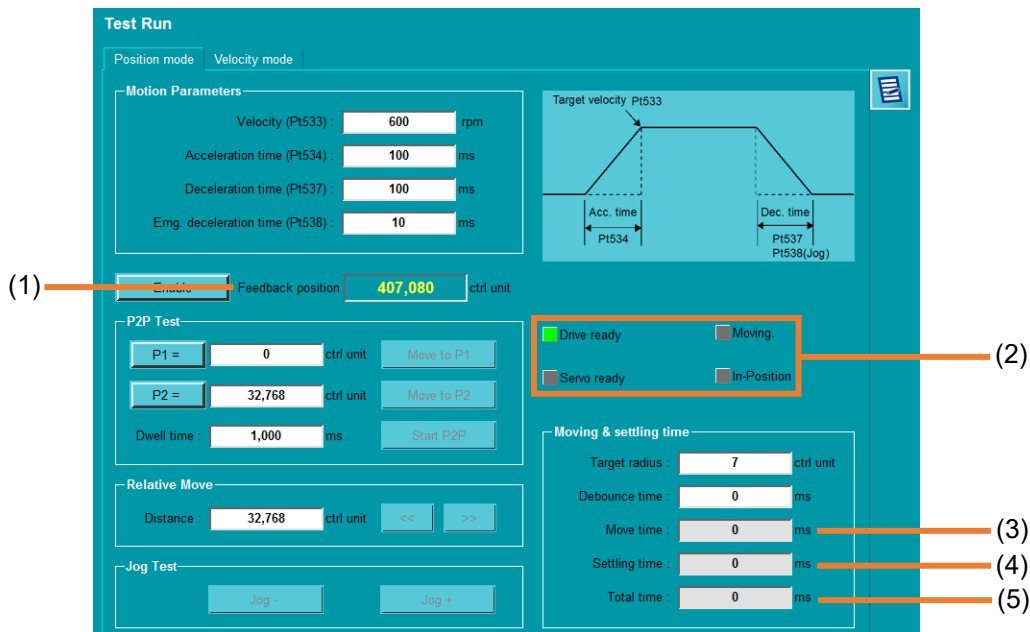

Figure 5.2.2.3

Table 5.2.2.2

No.	Item	Description	Reference
(1)	Feedback position	Show the feedback of motor's encoder position.	--
(2)	Status display area	<p>Drive ready: When it lights up in green, the servo drive is ready.</p> <p>Servo ready: Display whether the motor is enabled. If it lights up in green after users click Enable, servo is ready.</p> <p>Moving: When it lights up in green, the motor is moving.</p> <p>In-Position: When it lights up in green, the motor reaches the position.</p>	--
(3)	Move time	Display the time when the command is sent to the command ends.	section 8.4.4 in "E1 Series Servo Drive User Manual"
(4)	Settling time	Display the time when the command ends to the motor is in-position.	section 8.4.4 in "E1 Series Servo Drive User Manual"

(5)	Total time	Display the time when the motor starts moving to the motor is in-position.	section 8.4.4 in “E1 Series Servo Drive User Manual”
-----	------------	--	--



If an alarm occurs during test run, the motor will be automatically disabled.

Important

4. After clicking **Enable**, users can perform relative move and jog test.

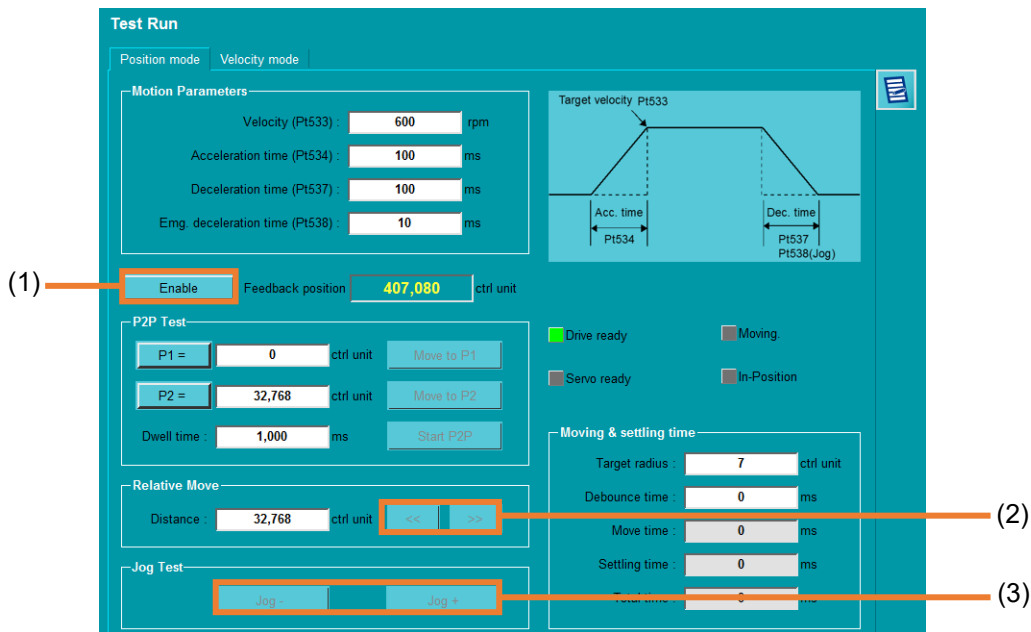



Figure 5.2.2.4

Table 5.2.2.3

No.	Item	Description
(1)	Enable button	Click the button to enable or disable the motor.
(2)	Relative move	Click << or >> to do relative move test in negative or positive direction. Deceleration time (Pt537) is used.  Important
(3)	Jog test	Jog- : Move toward negative direction. Continuously click Jog- to continuously jog in negative direction. Jog+ : Move toward positive direction. Continuously click Jog+ to continuously jog in positive direction. Emg. deceleration time (Pt538) is used.  Important

5. Perform single point move or point-to-point move.

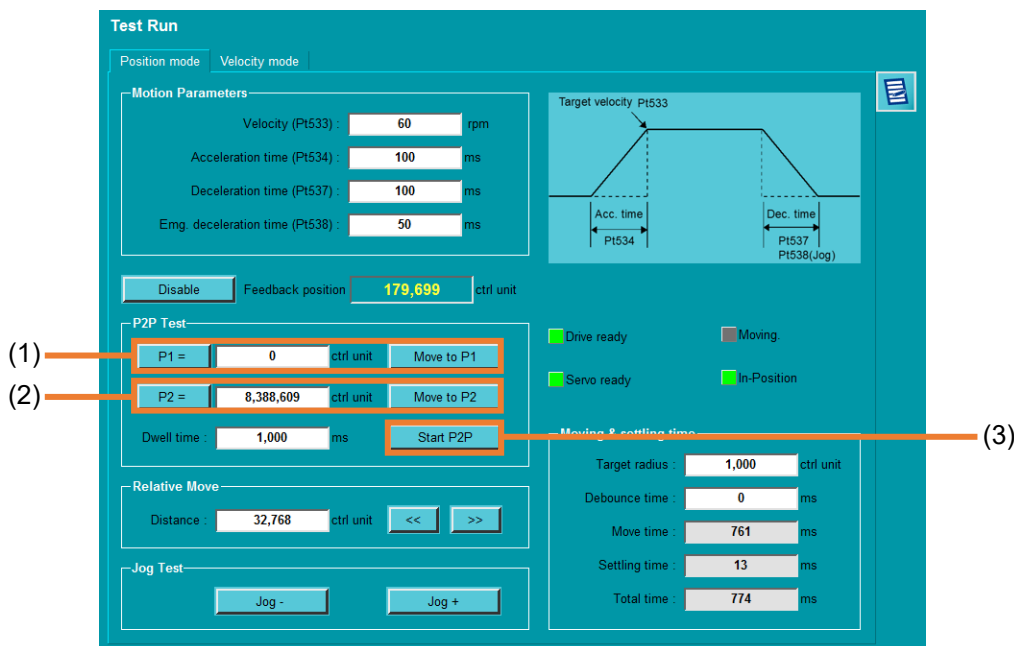



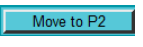



Figure 5.2.2.5

Table 5.2.2.4

No.	Item	Description
(1)	P1 coordinate	<ol style="list-style-type: none"> Set start position P1. Users can directly key in the coordinate in the column or click  to set the current motor position as the start coordinate. Click  to move the motor to target position P1.  P1 must be smaller than P2. Important
(2)	P2 coordinate	<ol style="list-style-type: none"> Set start position P2. Users can directly key in the coordinate in the column or click  to set the current motor position as the start coordinate. Click  to move the motor to target position P2.  P1 must be smaller than P2. Important
(3)	Start P2P	Click the button to start or stop point-to-point move test.

5.2.3 Velocity mode

Users can perform velocity mode test to observe motor's performance. After ensuring the servo drive is ready, follow the procedure below to execute velocity mode test.

1. Click "Open Test Run" icon in the toolbar to open "Test Run" window.

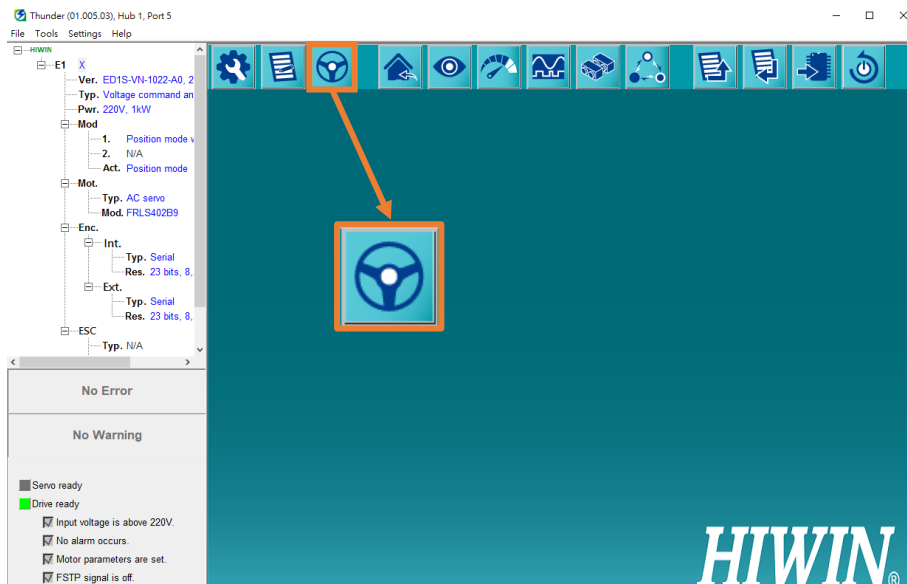

Figure 5.2.3.1

2. Click **Velocity mode** to switch to "Velocity mode" page.

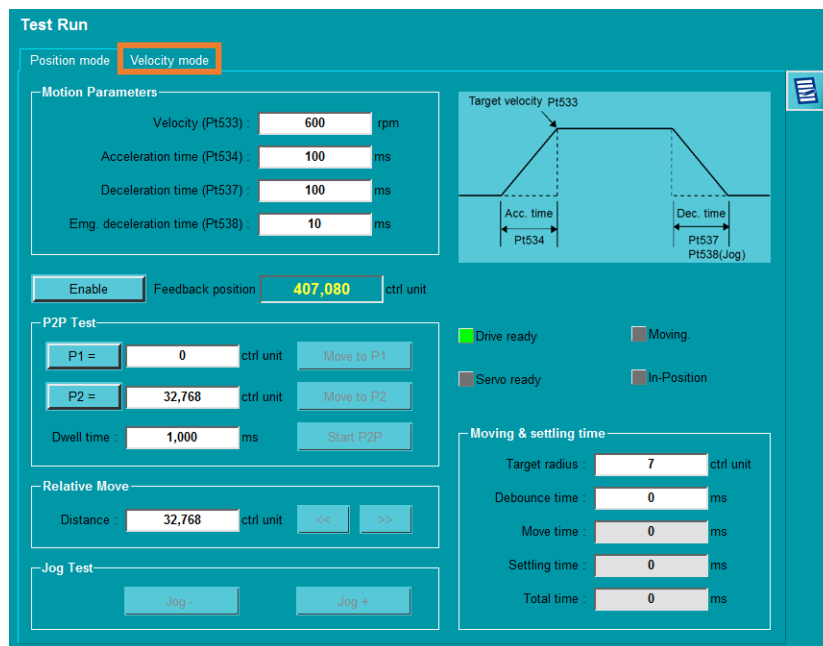

Figure 5.2.3.2



Before switching from position mode to velocity mode, disable the motor.

Important

3. Set parameters for velocity mode test.

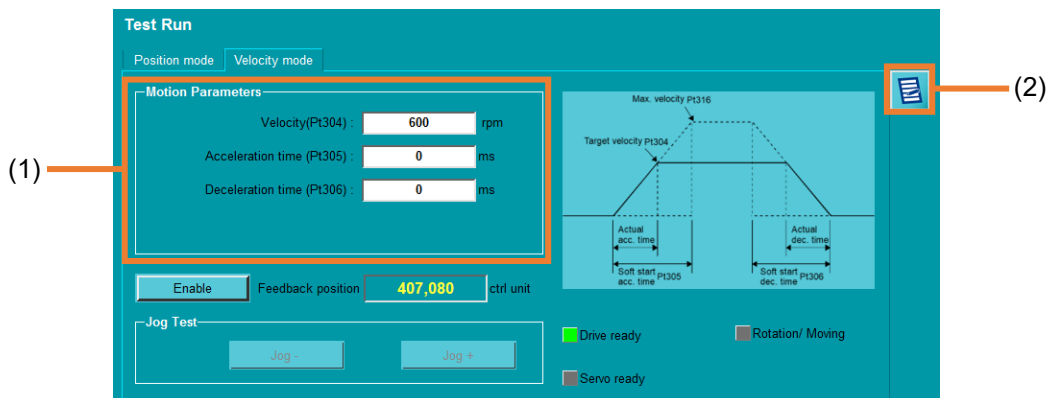

Figure 5.2.3.3

Table 5.2.3.1

No.	Item	Description	Reference
(1)	Motion parameters	Velocity: Jog velocity ◆ Rotary motor rpm (Pt304) ◆ Linear motor mm/s (Pt383) Acceleration time: Soft start acceleration time (Pt305) Deceleration time: Soft start deceleration time (Pt306)	section 8.7.1 in “E1 Series Servo Drive User Manual”
(2)	Parameters setup	Open Parameters Setup window.	section 4.4

4. Observe the status in velocity mode test.

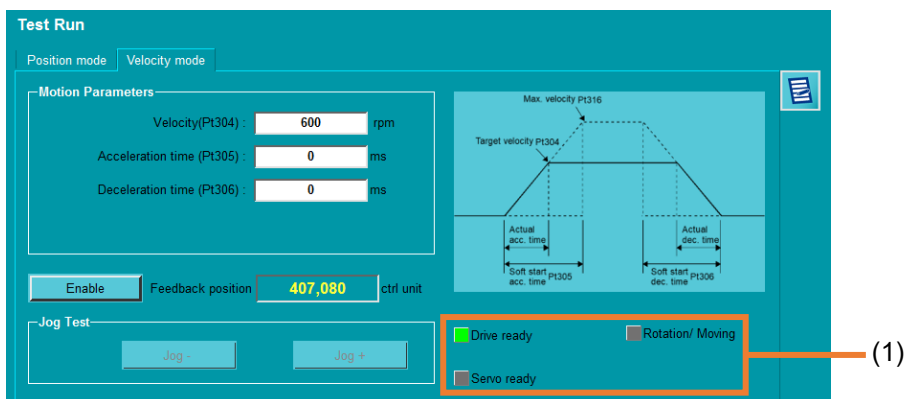

Figure 5.2.3.4

Table 5.2.3.2

No.	Item	Description	Reference
(1)	Status display area	<p>Drive ready: When it lights up in green, the servo drive is ready.</p> <p>Servo ready: Display whether the motor is enabled. If it lights up in green after users click Enable, servo is ready.</p> <p>Rotation / Moving: Rotation signal detection; when it lights up in green, TGON signal is triggered.</p>	section 8.1.7 in “E1 Series Servo Drive User Manual”

5. After clicking **Enable**, users can perform jog test.

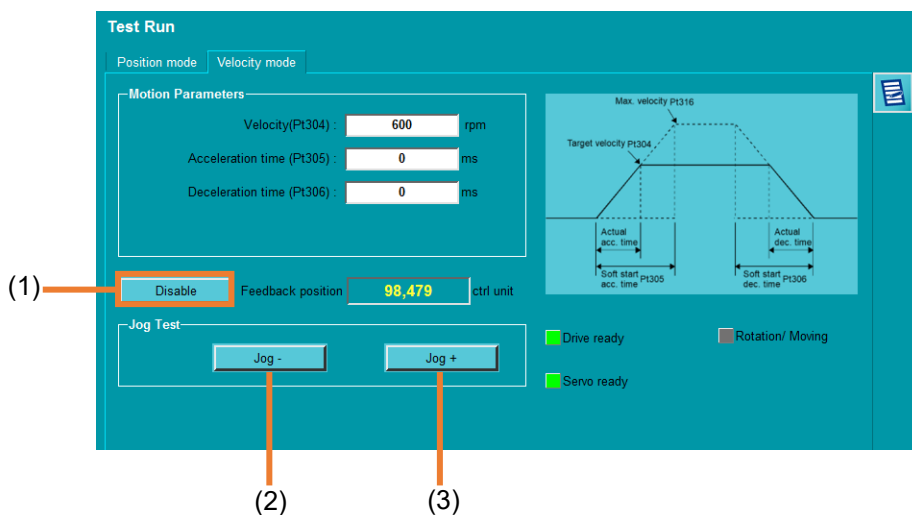

Figure 5.2.3.5

Table 5.2.3.3

No.	Item	Description
(1)	Enable button	Click the button to enable or disable the motor.
(2)	Negative jog	Move toward negative direction. Continuously click Jog- to continuously jog in negative direction.
(3)	Positive jog	Move toward positive direction. Continuously click Jog+ to continuously jog in positive direction.

5.3 Homing Operation

WARNING

- ◆ The failure of homing procedure will make absolute move unable to be correctly executed or make mechanism collide. Refer to section 8.11.3 in “E1 Series Servo Drive User Manual” for troubleshooting methods and causes.

Users can define home position or absolute coordinate based on the condition of external equipment. After ensuring the servo drive is ready, follow the procedure below to execute homing.



Information

For some servo motors, phase initialization must be done before homing. Refer to section 4.6 for detailed descriptions.

1. Click “Open Homing Operation” icon in the toolbar to open “Homing Operation” window.

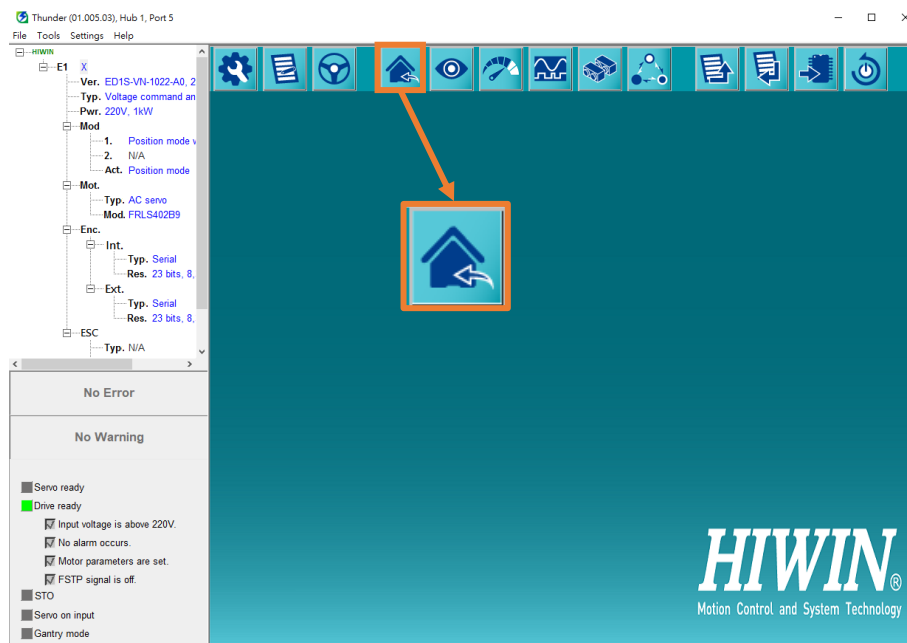

Figure 5.3.1

2. Set homing parameters and select homing method.

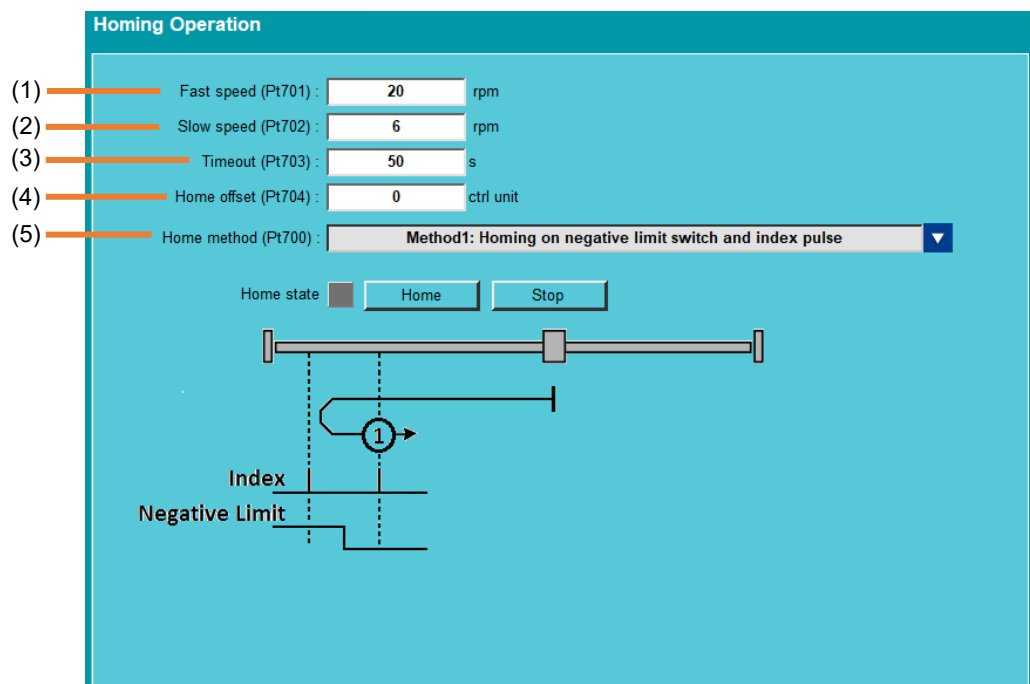

Figure 5.3.2

Table 5.3.1

No.	Item	Description	Reference
(1)	Fast homing speed	Set the velocity for finding near home sensor. ◆ Rotary motor (Pt701) ◆ Linear motor (Pt705)	section 8.11.1 in “E1 Series Servo Drive User Manual”
(2)	Slow homing speed	Set the velocity for finding home position. ◆ Rotary motor (Pt702) ◆ Linear motor (Pt706)	section 8.11.1 in “E1 Series Servo Drive User Manual”
(3)	Timeout	Set the time limit for homing procedure (Pt703).	section 8.11.1 in “E1 Series Servo Drive User Manual”
(4)	Home offset	Set home offset (Pt704).	section 8.11.1 in “E1 Series Servo Drive User Manual”
(5)	Home method	Select homing method (Pt700).	Table 5.3.3

3. Click **Home** to execute homing.

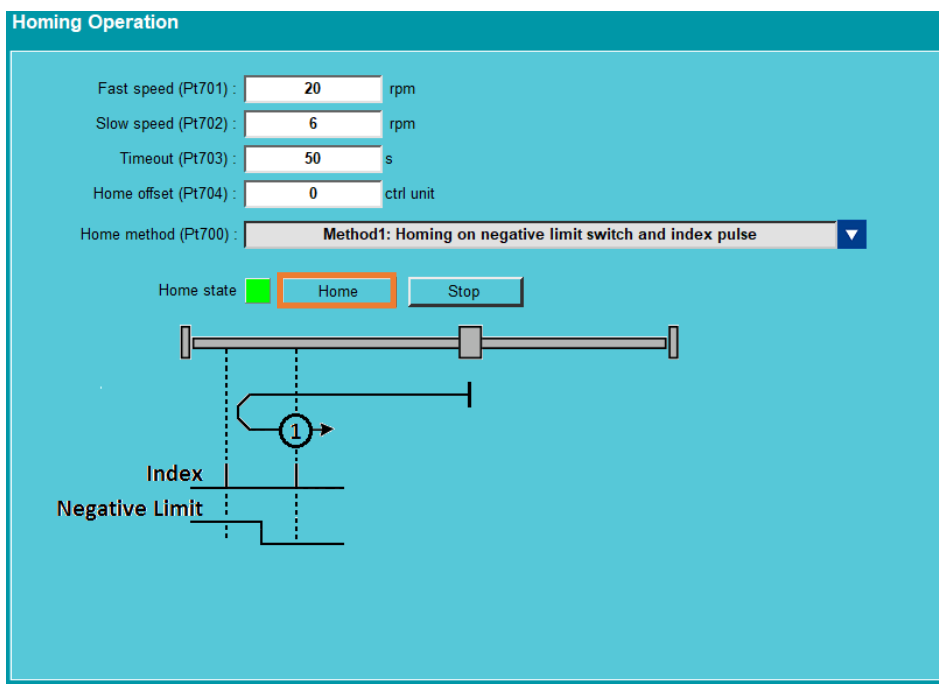

Figure 5.3.3

- Wait until the homing procedure is done, and observe the light display.

Table 5.3.2

Diagram	Description
Home state	When it displays gray light, homing is not activated.
Home state	When it displays green flashing light, the motor is moving.
Home state	When it displays green light, homing is done.
Home state	When it displays red light, homing fails.



To stop homing procedure during motor moving process, click **Stop**.

Information

Table 5.3.3

Item	Description	Diagram
Pt700 = 1	Homing with the index signal on the right of N-OT signal from negative direction. Search for N-OT signal in negative direction at the velocity for finding near home sensor (rotary servo motor) (Pt701). After N-OT signal is found, search for the	

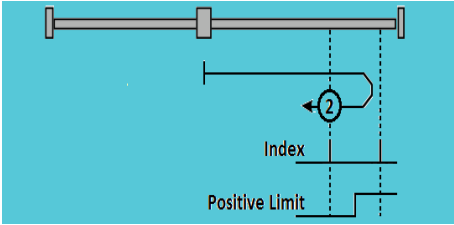
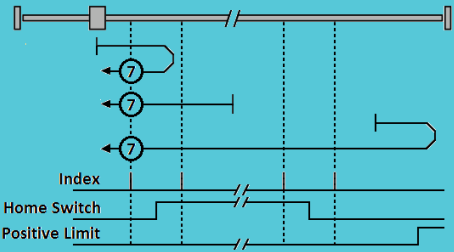
	<p>index signal in positive direction at the velocity for finding home position (rotary servo motor) (Pt702).</p>	
<p>Pt700 = 2</p>	<p>Homing with the index signal on the left of P-OT signal from positive direction. Search for P-OT signal in positive direction at the velocity for finding near home sensor (rotary servo motor) (Pt701). After P-OT signal is found, search for the index signal in negative direction at the velocity for finding home position (rotary servo motor) (Pt702).</p>	
<p>Pt700 = 7</p>	<p>Homing with the index signal on the left of DOG signal.</p> <ol style="list-style-type: none"> (1) Outside DOG signal: Search for the rising edge of DOG signal in positive direction at the velocity for finding near home sensor (rotary servo motor) (Pt701). After the rising edge of DOG signal is found, search for the index signal on the left of DOG signal in negative direction at the velocity for finding home position (rotary servo motor) (Pt702). (2) Inside DOG signal: Search for the falling edge of DOG signal in negative direction at the velocity for finding near home sensor (rotary servo motor) (Pt701). After the falling edge of DOG signal is found, search for the index signal on the left of DOG signal in negative direction at the velocity for finding home position (rotary servo motor) (Pt702). (3) Outside DOG signal: Search for P-OT signal in positive direction at the velocity for finding near home sensor (rotary servo motor) (Pt701). After P-OT signal is found, search for the index signal on the left of DOG signal in negative direction at the velocity for finding home position (rotary servo motor) (Pt702). 	

	<p>position (rotary servo motor) (Pt702).</p>	
<p>Pt700 = 8</p>	<p>Homing with the index signal on the right of DOG signal.</p> <p>(1) Outside DOG signal: Search for the rising edge of DOG signal in positive direction at the velocity for finding near home sensor (rotary servo motor) (Pt701). After the rising edge of DOG signal is found, search for the index signal on the right of DOG signal in positive direction at the velocity for finding home position (rotary servo motor) (Pt702).</p> <p>(2) Inside DOG signal: Search for the falling edge of DOG signal in negative direction at the velocity for finding near home sensor (rotary servo motor) (Pt701). After the falling edge of DOG signal is found, search for the index signal on the right of DOG signal in positive direction at the velocity for finding home position (rotary servo motor) (Pt702).</p> <p>(3) Outside DOG signal: Search for P-OT signal in positive direction at the velocity for finding near home sensor (rotary servo motor) (Pt701). After P-OT signal is found, search for the falling edge of DOG signal in negative direction. After the falling edge of DOG signal is found, search for the index signal on the right of DOG signal in positive direction at the velocity for finding home position (rotary servo motor) (Pt702).</p>	
<p>Pt700 = 9</p>	<p>Homing with the index signal on the left of the falling edge of DOG signal from positive direction.</p> <p>(1) Outside DOG signal: Search for the falling edge of DOG signal in positive direction at the velocity for finding near home sensor (rotary servo motor)</p>	

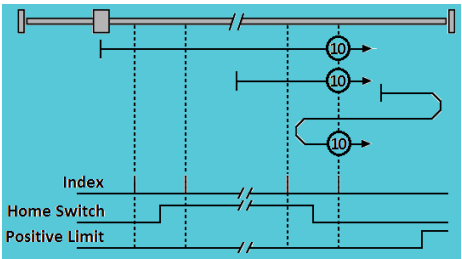

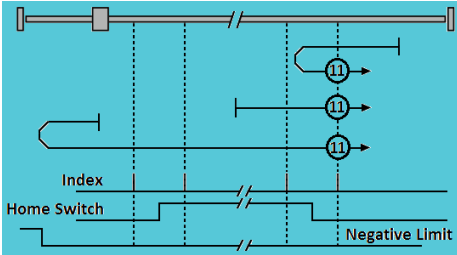

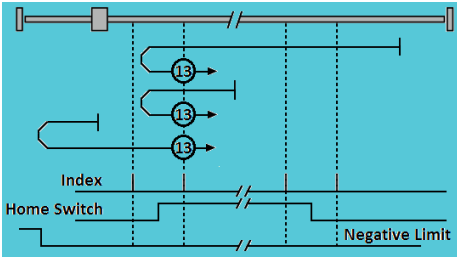

	<p>(Pt701). After the falling edge of DOG signal is found, search for the index signal on the left of DOG signal in negative direction at the velocity for finding home position (rotary servo motor) (Pt702).</p> <p>(2) Inside DOG signal: Search for the falling edge of DOG signal in positive direction at the velocity for finding near home sensor (rotary servo motor) (Pt701). After the falling edge of DOG signal is found, search for the index signal on the left of DOG signal in negative direction at the velocity for finding home position (rotary servo motor) (Pt702).</p> <p>(3) Outside DOG signal: Search for P-OT signal in positive direction at the velocity for finding near home sensor (rotary servo motor) (Pt701). After P-OT signal is found, search for the rising edge of DOG signal in negative direction. After the rising edge of DOG signal is found, search for the index signal on the left of DOG signal in negative direction at the velocity for finding home position (rotary servo motor) (Pt702).</p>	
<p>Pt700 = 10</p>	<p>Homing with the index signal on the right of the falling edge of DOG signal from positive direction.</p> <p>(1) Outside DOG signal: Search for the falling edge of DOG signal in positive direction at the velocity for finding near home sensor (rotary servo motor) (Pt701). After the falling edge of DOG signal is found, search for the index signal on the right of DOG signal in positive direction at the velocity for finding home position (rotary servo motor) (Pt702).</p> <p>(2) Inside DOG signal: Search for the falling edge of DOG signal in</p>	

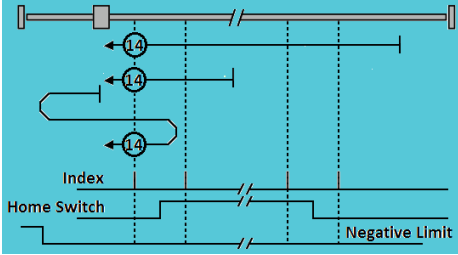
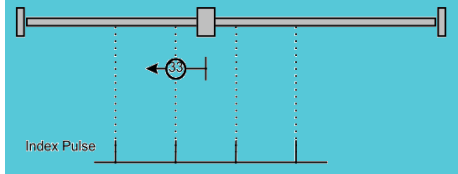
	<p>positive direction at the velocity for finding near home sensor (rotary servo motor) (Pt701). After the falling edge of DOG signal is found, search for the index signal on the right of DOG signal in positive direction at the velocity for finding home position (rotary servo motor) (Pt702).</p> <p>(3) Outside DOG signal: Search for P-OT signal in positive direction at the velocity for finding near home sensor (rotary servo motor) (Pt701). After P-OT signal is found, search for the rising edge of DOG signal in negative direction. After the rising edge of DOG signal is found, search for the index signal on the right of DOG signal in positive direction at the velocity for finding home position (rotary servo motor) (Pt702).</p>	
<p>Pt700 = 11</p>	<p>Homing with the index signal on the right of the rising edge of DOG signal from negative direction.</p> <p>(1) Outside DOG signal: Search for the rising edge of DOG signal in negative direction at the velocity for finding near home sensor (rotary servo motor) (Pt701). After the rising edge of DOG signal is found, search for the index signal on the right of DOG signal in positive direction at the velocity for finding home position (rotary servo motor) (Pt702).</p> <p>(2) Inside DOG signal: Search for the falling edge of DOG signal in positive direction at the velocity for finding near home sensor (rotary servo motor) (Pt701). After the falling edge of DOG signal is found, search for the index signal on the right of DOG signal in positive direction at the velocity for finding home</p>	

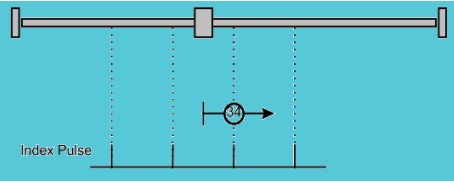
	<p>position (rotary servo motor) (Pt702).</p> <p>(3) Outside DOG signal: Search for N-OT signal in negative direction at the velocity for finding near home sensor (rotary servo motor) (Pt701). After N-OT signal is found, search for the falling edge of DOG signal in positive direction. After the falling edge of DOG signal is found, search for the index signal on the right of DOG signal in positive direction at the velocity for finding home position (rotary servo motor) (Pt702).</p>	
<p>Pt700 = 12</p>	<p>Homing with the index signal on the left of the rising edge of DOG signal from negative direction.</p> <p>(1) Outside DOG signal: Search for the rising edge of DOG signal in negative direction at the velocity for finding near home sensor (rotary servo motor) (Pt701). After the rising edge of DOG signal is found, search for the index signal on the left of DOG signal in negative direction at the velocity for finding home position (rotary servo motor) (Pt702).</p> <p>(2) Inside DOG signal: Search for the falling edge of DOG signal in positive direction at the velocity for finding near home sensor (rotary servo motor) (Pt701). After the falling edge of DOG signal is found, search for the index signal on the left of DOG signal in negative direction at the velocity for finding home position (rotary servo motor) (Pt702).</p> <p>(3) Outside DOG signal: Search for N-OT signal in negative direction at the velocity for finding near home sensor (rotary servo motor) (Pt701). After N-OT signal is found, search for the falling edge</p>	

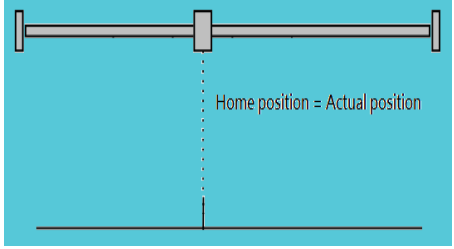
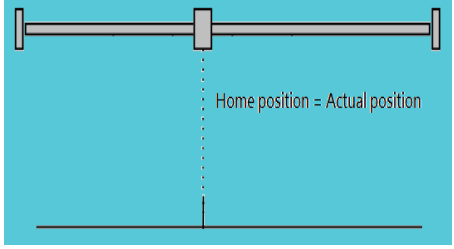
	<p>of DOG signal in positive direction. After the falling edge of DOG signal is found, search for the index signal on the left of DOG signal in negative direction at the velocity for finding home position (rotary servo motor) (Pt702).</p>	
<p>Pt700 = 13</p>	<p>Homing with the index signal on the right of the falling edge of DOG signal from negative direction.</p> <p>(1) Outside DOG signal: Search for the falling edge of DOG signal in negative direction at the velocity for finding near home sensor (rotary servo motor) (Pt701). After the falling edge of DOG signal is found, search for the index signal on the right of DOG signal in positive direction at the velocity for finding home position (rotary servo motor) (Pt702).</p> <p>(2) Inside DOG signal: Search for the falling edge of DOG signal in negative direction at the velocity for finding near home sensor (rotary servo motor) (Pt701). After the falling edge of DOG signal is found, search for the index signal on the right of DOG signal in positive direction at the velocity for finding home position (rotary servo motor) (Pt702).</p> <p>(3) Outside DOG signal: Search for N-OT signal in negative direction at the velocity for finding near home sensor (rotary servo motor) (Pt701). After N-OT signal is found, search for the rising edge of DOG signal in positive direction. After the rising edge of DOG signal is found, search for the index signal on the right of DOG signal in positive direction at the velocity for finding home position (rotary servo motor) (Pt702).</p>	

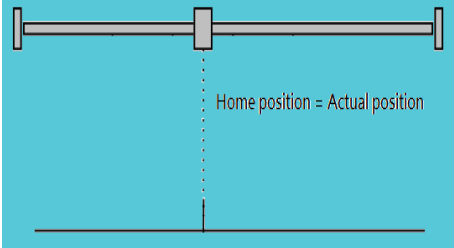
<p>Pt700 = 14</p>	<p>Homing with the index signal on the left of the falling edge of DOG signal from negative direction.</p> <p>(1) Outside DOG signal: Search for the falling edge of DOG signal in negative direction at the velocity for finding near home sensor (rotary servo motor) (Pt701). After the falling edge of DOG signal is found, search for the index signal on the left of DOG signal in negative direction at the velocity for finding home position (rotary servo motor) (Pt702).</p> <p>(2) Inside DOG signal: Search for the falling edge of DOG signal in negative direction at the velocity for finding near home sensor (rotary servo motor) (Pt701). After the falling edge of DOG signal is found, search for the index signal on the left of DOG signal in negative direction at the velocity for finding home position (rotary servo motor) (Pt702).</p> <p>(3) Outside DOG signal: Search for N-OT signal in negative direction at the velocity for finding near home sensor (rotary servo motor) (Pt701). After N-OT signal is found, search for the rising edge of DOG signal in positive direction. After the rising edge of DOG signal is found, search for the index signal on the left of DOG signal in negative direction at the velocity for finding home position (rotary servo motor) (Pt702).</p>	 <p>The diagram shows a horizontal axis representing position. A Home Switch signal is shown as a pulse. An Index signal is shown as a pulse. A Negative Limit signal is shown as a pulse. Three arrows labeled '14' point to the left, indicating the search direction for the falling edge of the DOG signal, the index signal, and the rising edge of the DOG signal.</p>
<p>Pt700 = 33</p>	<p>Homing with index signal from negative direction. Search for index signal in negative direction at the velocity for finding home position (rotary servo motor) (Pt702).</p>	 <p>The diagram shows a horizontal axis representing position. An Index Pulse signal is shown as a pulse. An arrow labeled '33' points to the left, indicating the search direction for the index signal.</p>

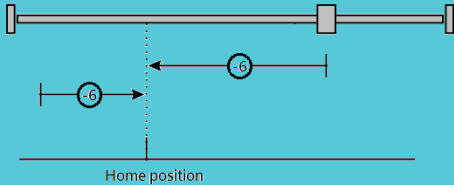
<p>Pt700 = 34</p>	<p>Homing with index signal from positive direction. Search for index signal in positive direction at the velocity for finding home position (rotary servo motor) (Pt702).</p>	
<p>Pt700 = 35</p>	<p>Homing with current position. The current position of the motor is regarded as home position.</p> <p> This homing method is the same as homing method 37, but it is for EtherCAT controller which does not support CiA 402 homing method.</p>	
<p>Pt700 = 37</p>	<p>Homing with current position. The current position of the motor is regarded as home position.</p>	
<p>Pt700 = -3</p>	<p>Homing with current position. The current position of the motor is regarded as home position. This homing method is suitable for application using multi-turn absolute encoder.</p> <p> If Pt002 = t.X□□ is not correctly set (refer to chapter 15 in “E1 Series Servo Drive User Manual”), homing could fail.</p>	
<p>Pt700 = -6</p>	<p>Homing with home position. Move the motor to the home position set by homing method -3 at the velocity for finding near home sensor (rotary servo motor) (Pt701). This homing method is suitable for application using multi-turn absolute encoder.</p> <p> If Pt002 = t.X□□ is not correctly set (refer to chapter 15 in “E1 Series</p>	

	Servo Drive User Manual”), homing could fail.	
--	--	--

6. Tuning

6.	Tuning	6-1
6.1	Brief introduction	6-2
6.2	Auto tune	6-4
6.3	Tuneless	6-9
6.4	Spectrum analyzer	6-12

6.1 Brief introduction

Users can optimize the response of motor by adjusting servo gains. Servo gains are set by several parameters (position loop gain, velocity loop gain, filter, vibration suppression and feedforward compensation). Gain-related parameters can affect the performance of each other, so please consider the balance among their settings. The default settings of gain-related parameters are set to have relatively stable servo gains. Use tuning functions provided in E1 series servo drive to improve response performance according to your mechanism and operating condition.

The flow chart for tuning procedure is as below.

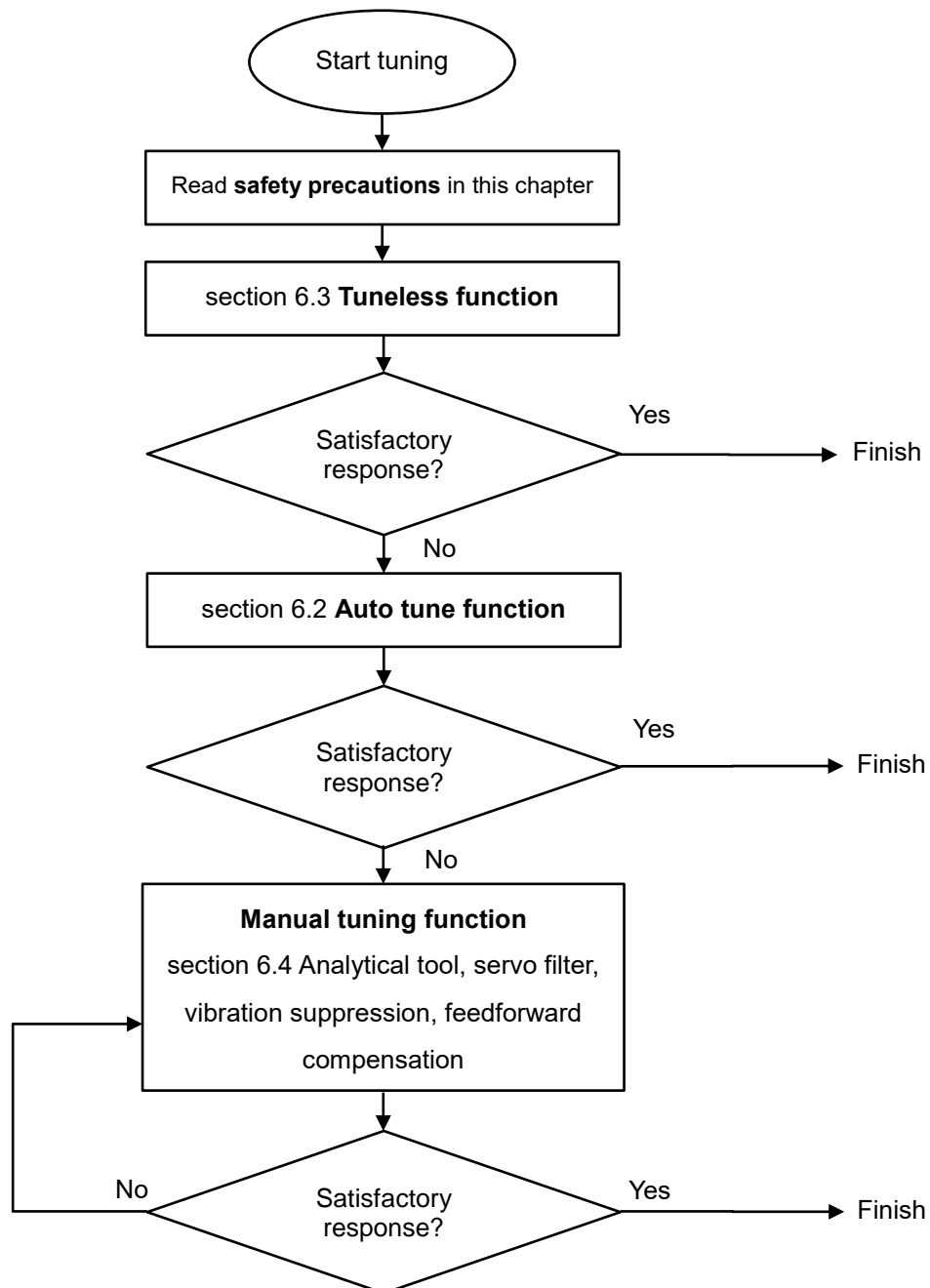

Figure 6.1.1



Refer to chapter 10 in “E1 Series Servo Drive User Manual” for the detailed tuning methods and contents.

Information

CAUTION

- ◆ Ensure the precautions below are followed when tuning.
 - (1) Do not touch the rotating parts of motor when servo ON.
 - (2) Ensure emergency stop can be activated anytime when motor is in operation.
 - (3) Perform tuning after test run is completed.
 - (4) For safety, install a stopping device on mechanism.

6.2 Auto tune

In auto tune, the servo drive automatically adjusts control loops without receiving commands from the controller. During the process, parameters will be adjusted according to mechanical characteristics. The items of auto tune are shown as below:

- ◆ Gain: velocity loop gain, position loop gain and moment of inertia ratio
- ◆ Filter: torque command filter and notch filter



Important

Auto tune cannot be performed when tuneless function is enabled (Pt170.□□□X = 1). Before performing auto tune, please disable tuneless function (Pt170.□□□X = 0) first.

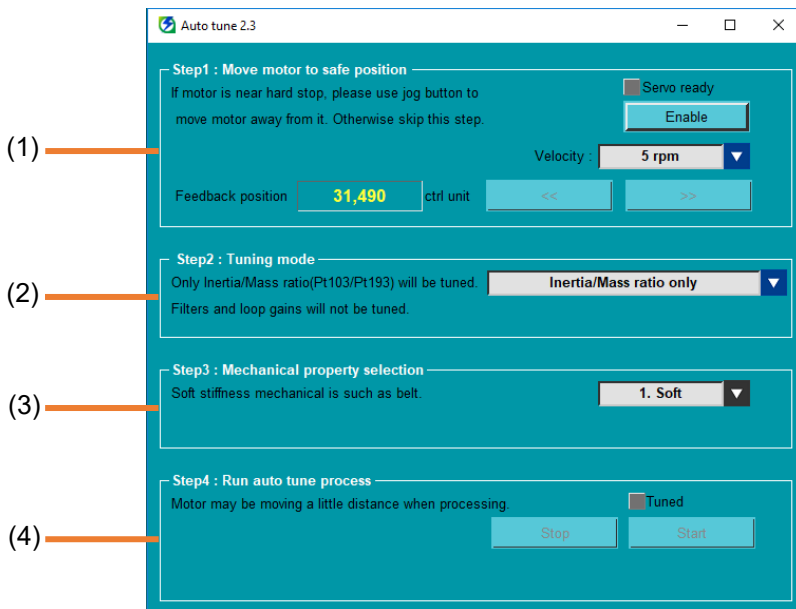

Figure 6.2.1

Table 6.2.1

No.	Item	Description
(1)	Enable motor and JOG	Click Enable to move the motor away from hard stop with JOG mode. Adjust JOG velocity via the drop-down menu.
(2)	Selection of tuning mode	It is a drop-down menu for users to select “tune Inertia/Mass ratio only” or “tune Inertia/Mass ratio, filters and loop gains”.
(3)	Selection of mechanical property	It is a drop-down menu which provides three selections for stiffness (Soft / Normal / Rigid).
(4)	Start auto tune	Click Start to start auto tune. To pause during the process, click Stop .

WARNING

- ◆ During auto tune, the motor slightly vibrates. If it vibrates severely, please immediately turn off the power. Pay attention to the following.
 - (1) Check if the mechanism can be operated safely. Ensure emergency stop (Power OFF) can be activated anytime while performing auto tune, as the motor will slightly vibrate. Besides, make sure mechanism can be operated in both directions and implement protective measures.

CAUTION

- ◆ Auto tune **cannot** be performed on the following systems.
 - (1) The mechanism only operates towards one direction.
 - (2) The motor is controlled by external brake. The brake must be disabled.
- ◆ Auto tune **cannot** be correctly performed on the following systems.
 - (1) The range for motion is limited.
 - (2) The load is changed when auto tune is executed.
 - (3) The dynamic friction of machine is too large.
 - (4) The stiffness of machine is low and vibration occurs during positioning.
 - (5) Position integration function is enabled.
 - (6) Set or use velocity feedforward and torque feedforward.
 - (7) The load inertia ratio is over 100.
- ◆ Items to check before performing auto tune:
 - (1) The main circuit power must be ON.
 - (2) No overtravel occurs.
 - (3) Must be in servo OFF state.
 - (4) No alarm or warning occurs.
 - (5) Tuneless function must be disabled (Pt170.□□□X = 0).
 - (6) While performing auto tune, the control mode must be position mode. After auto tune finishes, the control mode can be changed to other mode, such as velocity mode.
 - (7) Gain switching selection must be set to manual gain switching (Pt139.□□□X = 0).

Follow the procedure below to complete auto tune.

1. Select **Tools** in the menu bar and click **Auto tune** to open “Auto tune” window.

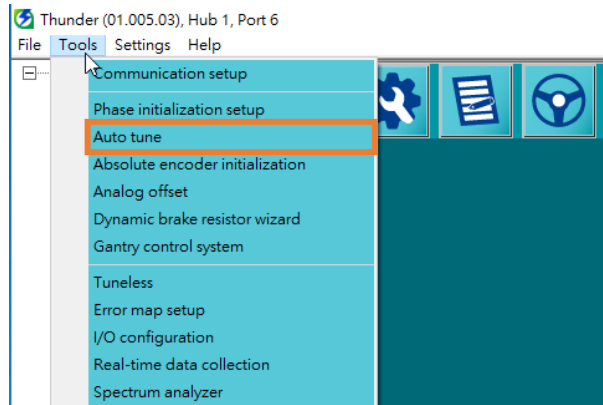

Figure 6.2.2

2. Adjust JOG velocity.

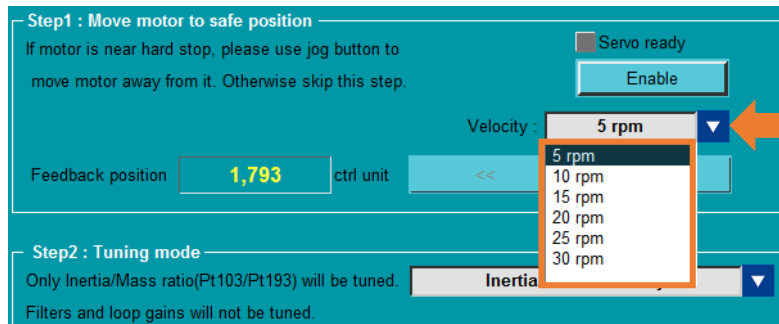

Figure 6.2.3

3. Click **Enable** to move the motor to safe place with JOG mode.

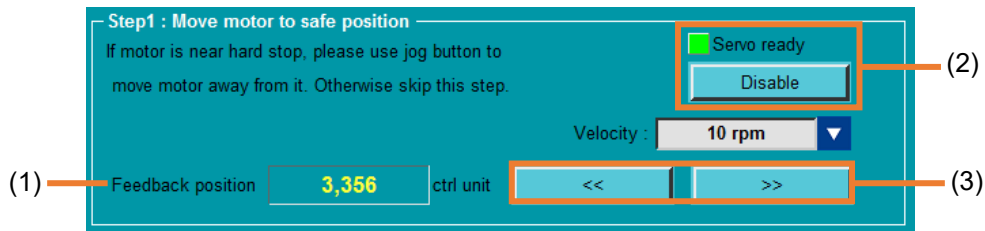

Figure 6.2.4

Table 6.2.2

No.	Item	Description
(1)	Encoder feedback position	Display the actual motor feedback position.
(2)	Enable and Disable	Click Enable to supply power to motor. If Servo ready lights up in green, power is supplied to motor.
(3)	Positive / Negative jog	After the motor is enabled, users can make it jog in positive or negative direction.

- Select tuning mode based on requirement. There are two modes, “tune Inertia/Mass ratio only” and “tune Inertia/Mass ratio, filters and loop gains”.

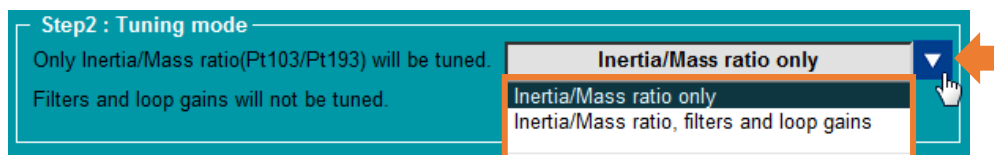

Figure 6.2.5

Table 6.2.3

Tuning mode	Description
Inertia/Mass ratio only	Only Inertia/Mass ratio (Pt103/Pt193) will be tuned. Filters and loop gains will not be tuned.
Inertia/Mass ratio, filters and loop gains	Inertia/Mass ratio (Pt103/Pt193), filters and loop gains will be automatically tuned.



Information

If **Inertia/Mass ratio only** is selected, there is no need to set mechanical property. The next step can be skipped, and its user interface will be hidden.

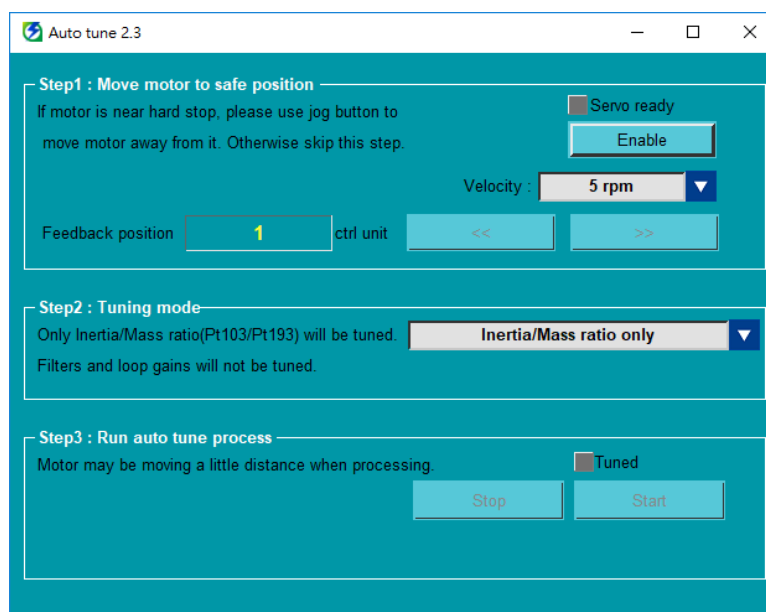

Figure 6.2.6

- Select mechanical property based on equipment. When the mechanical stiffness is unknown, select **Normal**.

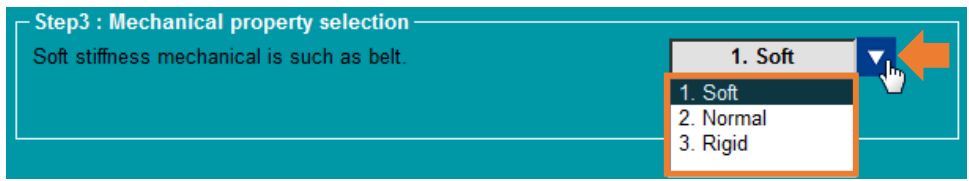

Figure 6.2.7

Table 6.2.4

Mechanical property	Description
Soft	Soft stiffness mechanical, such as belt.
Normal	Normal stiffness mechanical, such as ball screw or linear motor. Select this when the mechanical stiffness is unknown.
Rigid	Rigid stiffness mechanical, such as harmonic drive.

- Click **Start** to start auto tune. During the process, the motor will slightly vibrate and produce sounds. The window will also show the progress bar of “Tuning...”. When the window shows “Tuning is finished”, auto tune is done, and **Tuned** will light up in green.

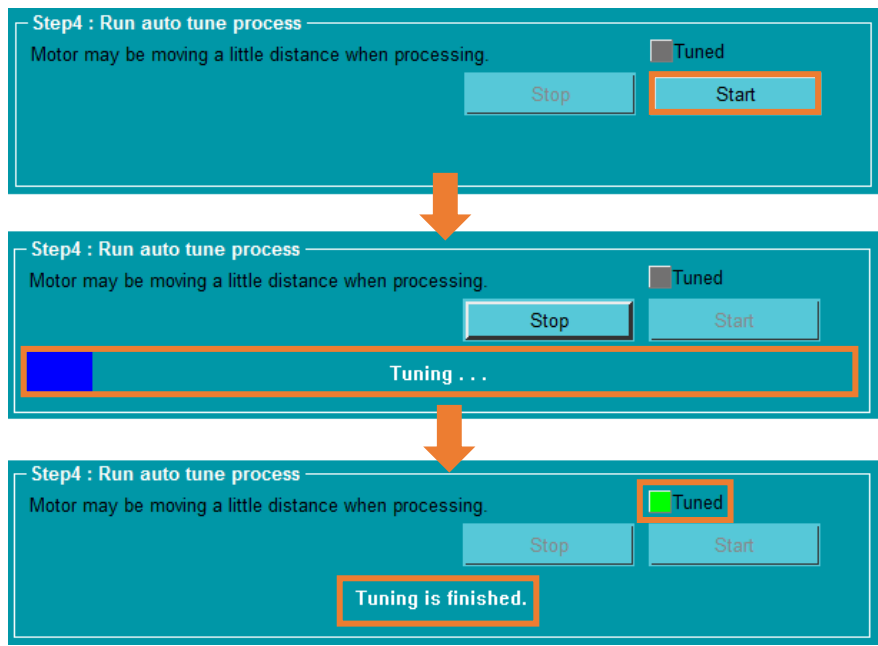

Figure 6.2.8



Important

To stop auto tune procedure during motor tuning process, click **Stop**.

6.3 Tuneless

Tuneless function can be applied for any machine type and load variation to have stable response performance. Tuneless function is automatically enabled after servo ON. Users can easily set tuneless stiffness level in “Tuneless” window.



Important

Tuneless function cannot be performed when auto tune is enabled (Pt170.□□□X = 0). Before performing tuneless function, please disable auto tune (Pt170.□□□X = 1) first.

CAUTION

- ◆ Tuneless function cannot be applied in torque control.
- ◆ When the allowable load moment of inertia is exceeded, the motor may vibrate. At this time, decrease stiffness level of tuneless function (Pt170.□X□□).
- ◆ While executing tuneless function, ensure emergency stop can be activated anytime.
- ◆ When tuneless function is enabled, some of the control functions are limited, as the following table shows.

Table 6.3.1

Function	Effective	Note
Auto tune	No	Auto tune can only be executed after tuneless function is disabled (Pt170.□□□X = 0).
Vibration suppression	Yes	--
Gain switching	No	Gain switching function can only be executed after tuneless function is disabled (Pt170.□□□X = 0).
Spectrum analyzer	Yes	--
Ripple compensation	No	Ripple compensation function can only be executed after tuneless function is disabled (Pt170.□□□X = 0).
Friction compensation	No	Friction compensation function can only be executed after tuneless function is disabled (Pt170.□□□X = 0).

WARNING

- ◆ Some parameters will become invalid when tuneless function is enabled (Pt170.□□□X = 1). Refer to section 10.3.4 in “E1 Series Servo Drive User Manual” for details.
- ◆ The following parameters will be automatically adjusted while executing tuneless function. Do not modify the parameters after tuneless function is enabled.

Table 6.3.2

Parameter	Parameter name
Pt401	First stage first torque command filter time constant
Pt40F	Second stage second torque command filter frequency
Pt410	Second stage second torque command Q value

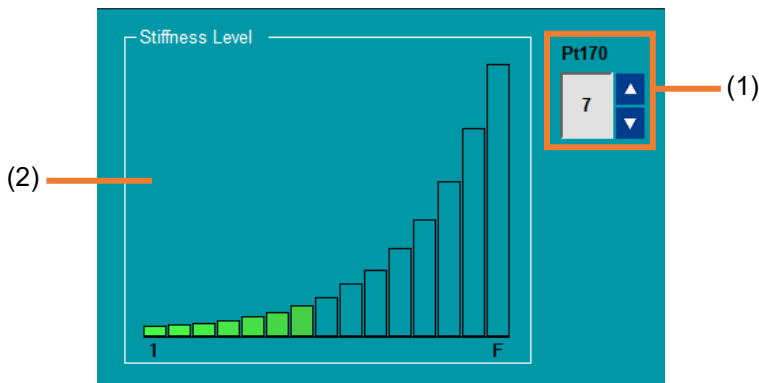

Figure 6.3.1

Table 6.3.3

No.	Item	Description
(1)	Tuneless stiffness level	Modify tuneless stiffness level.
(2)	Diagram of tuneless stiffness level	Display tuneless stiffness level.

Follow the procedure below to complete tuneless function.

1. Select **Tools** in the menu bar and click **Tuneless** to open “Tuneless” window.

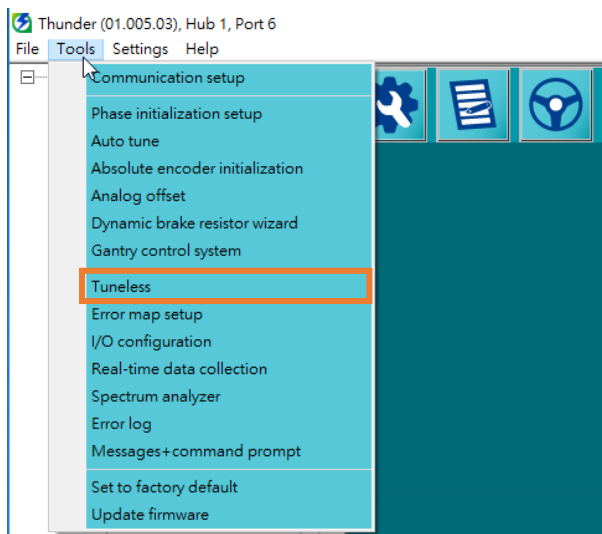

Figure 6.3.2

- Adjust stiffness level based on actual situation. There are fifteen levels (1~F); 1 is the lowest, while F is the highest.

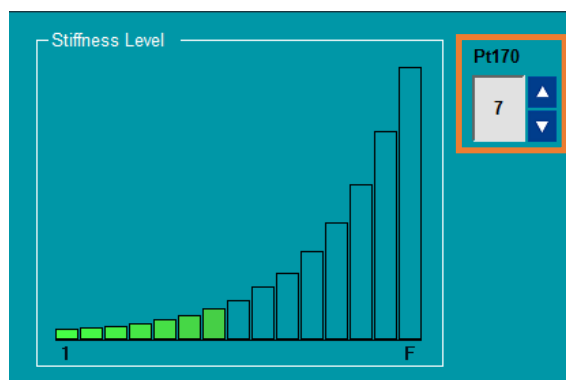

Figure 6.3.3

6.4 Spectrum analyzer

With spectrum analyzer, users can not only measure system's spectrum characteristics but also get mechanical inertia and moment of inertia ratio.

⚠ WARNING

- ◆ During the process of performing spectrum analyzer, the motor slightly vibrates. If it vibrates severely, please immediately turn off the power. Pay attention to the following.
 - (1) Check if the mechanism can be operated safely. Ensure emergency stop (Power OFF) can be activated anytime while performing spectrum analyzer, as the motor will slightly vibrate. Besides, make sure mechanism can be operated in both directions and implement protective measures.

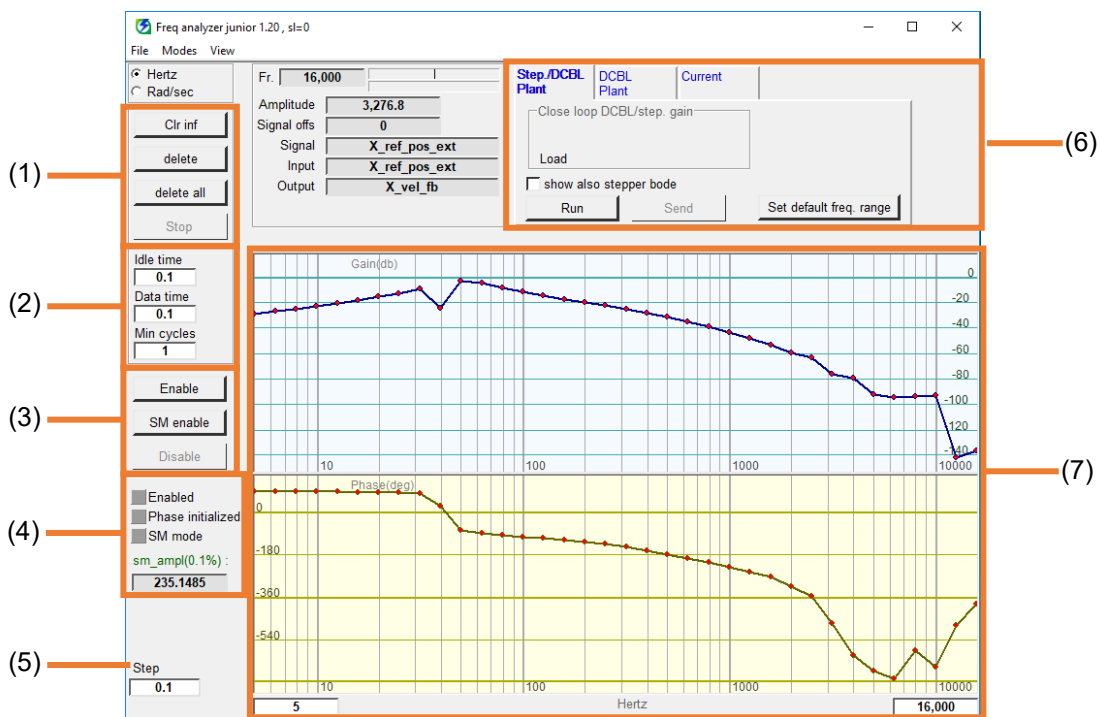

Figure 6.4.1

Table 6.4.1

No.	Item	Description
(1)	Function buttons	Include clear cursor line button (Clr inf), delete graph button (delete) and delete all graphs button (delete all).
(2)	Data settings	The settings for generating spectrum data.
(3)	Enable and Disable	Users can select SM enable (open loop) or Enable (closed loop).
(4)	Status lights	Display the status of spectrum analyzer.
(5)	Step	The interval of generating spectrum.

(6)	Mode selection	Users can select Step/DCBL Plant mode (open loop), DCBL Plant mode (closed loop) or Current mode.
(7)	Bode plot	System's frequency response graph; it provides a -20dB cursor line to calculate system's moment of inertia ratio.

Follow the procedure below to complete spectrum analyzer.

1. Select **Tools** in the menu bar and click **Spectrum analyzer** to open "Freq analyzer" window.

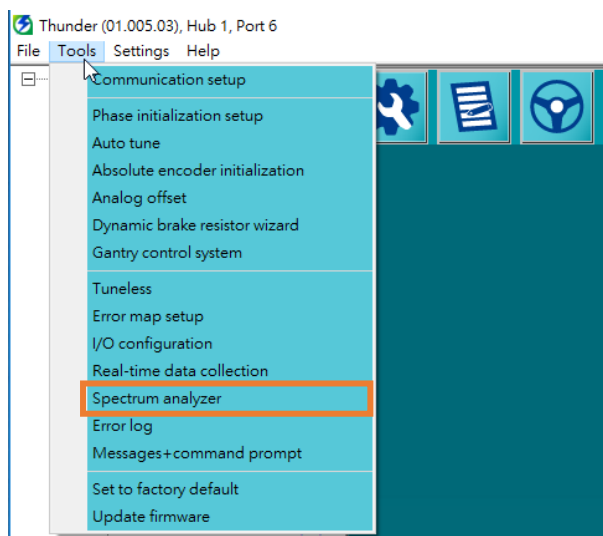

Figure 6.4.2

2. After selecting the desired mode, select the corresponding enable method.

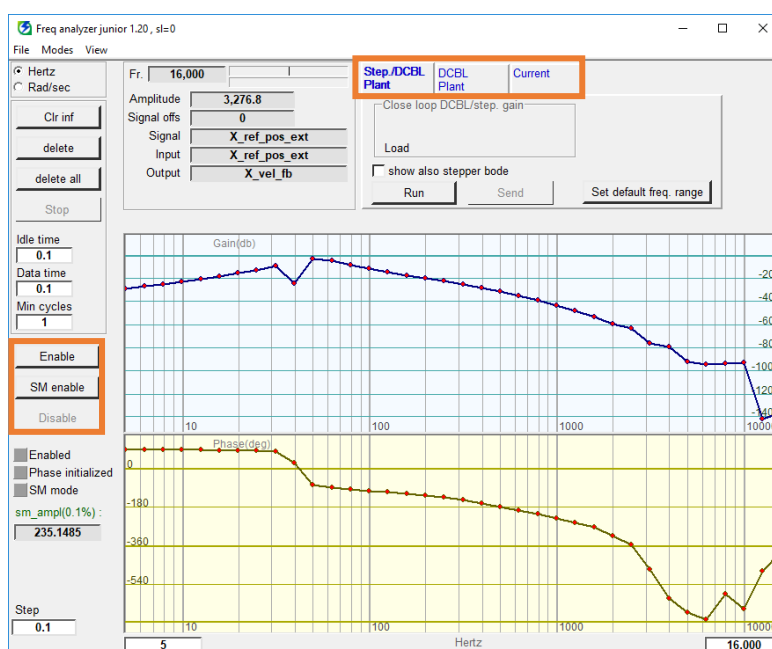

Figure 6.4.3

Table 6.4.2

Mode	Description
Step/DCBL Plant	Perform spectrum analyzer on open loop mode (click SM enable).
DCBL Plant	Perform spectrum analyzer on closed loop mode (click Enable).
Current	Perform spectrum analyzer on current mode (click SM enable).

- Click **Run** to start performing spectrum analyzer. When the execution is done, it will generate Bode plot.

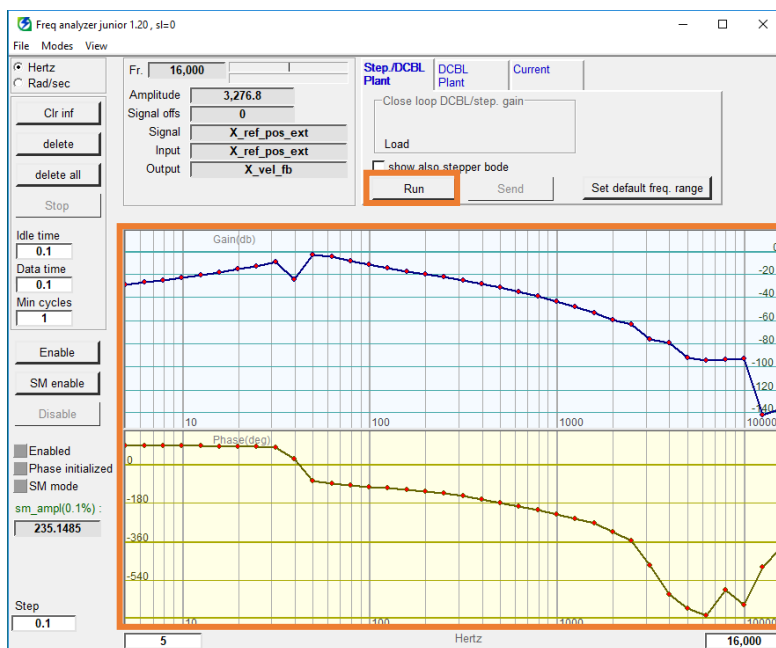

Figure 6.4.4

- Click Bode plot to generate a -20dB cursor line to measure the whole equipment's inertia. Drag it on the frequency response line to get the load.

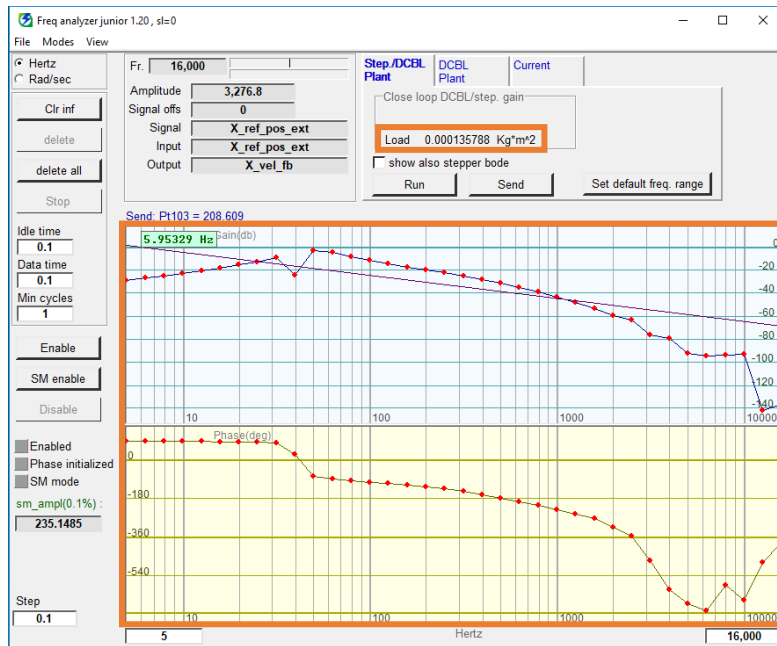

Figure 6.4.5

- Click **Send** to automatically modify the parameter of moment of inertia ratio. Pt103 is for single axis, while Pt193 is for gantry control system.

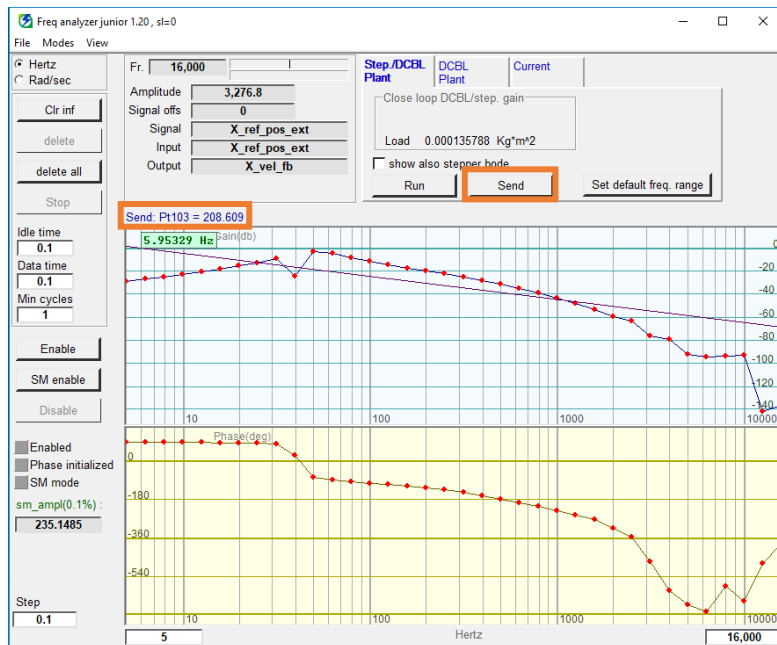

Figure 6.4.6

(This page is intentionally left blank.)

7. Monitoring

7.	Monitoring	7-1
7.1	Brief introduction	7-2
7.2	Monitor servo drive's information.....	7-3
7.3	Monitor servo drive's signal status	7-5
7.3.1	Lissajous	7-9
7.3.1.1	Waveform display area	7-10
7.4	Performance monitor	7-15
7.5	Scope.....	7-17
7.5.1	Current monitoring item	7-20
7.5.2	Start scope with pre defined variables/scenarios	7-21
7.5.3	Fix range/Auto range setup.....	7-23
7.5.4	Grid light.....	7-24
7.5.5	Set number of scope channels	7-26
7.5.6	Start or pause waveform monitoring	7-27
7.5.7	Monitoring items.....	7-28
7.6	Real-time data collection	7-30
7.6.1	Interface introduction	7-31
7.6.1.1	Save record settings	7-32
7.6.1.2	Load record settings	7-33
7.6.1.3	Operation and settings for collection	7-34
7.6.1.4	Add new tab	7-42
7.6.1.5	Sampling settings	7-43
7.6.2	Plot view.....	7-46
7.6.2.1	Open	7-47
7.6.2.2	Save.....	7-48
7.6.2.3	Set show mode	7-49
7.6.2.4	Set maximum number of graph views	7-51
7.6.2.5	Zoom the area between cursors.....	7-54
7.6.2.6	Undo zoom	7-55
7.6.2.7	Redo zoom	7-56
7.6.2.8	Statistics table.....	7-57

7.1 Brief introduction

Users can monitor servo drive's message, operation and status via Thunder. All the monitoring functions in Thunder are introduced in this chapter.

Monitor servo drive's information

Users can get servo drive's current information, such as the information of servo drive, motor and encoder.

Monitor servo drive's signal status

Users can get servo drive's real-time signal status, such as the voltage of main power cable, the current of motor, input commands, output values and the information of encoder.

Performance monitor

Users can adjust some motion parameters, and observe motor motion's status and performance in real-time.

Scope

Users can get servo drive's physical quantity and signal waveform without using measuring instrument.

Real-time data collection

Users can record servo drive's physical quantity and signal waveform for a period of time, and save them as a file (*.gpp).

7.2 Monitor servo drive's information

Users can get servo drive's current information. The items can be monitored are as below.

- ◆ Axis name of servo drive
- ◆ Specifications of servo drive
- ◆ Control mode
- ◆ Information of motor
- ◆ Information of encoder
- ◆ Information of ESC

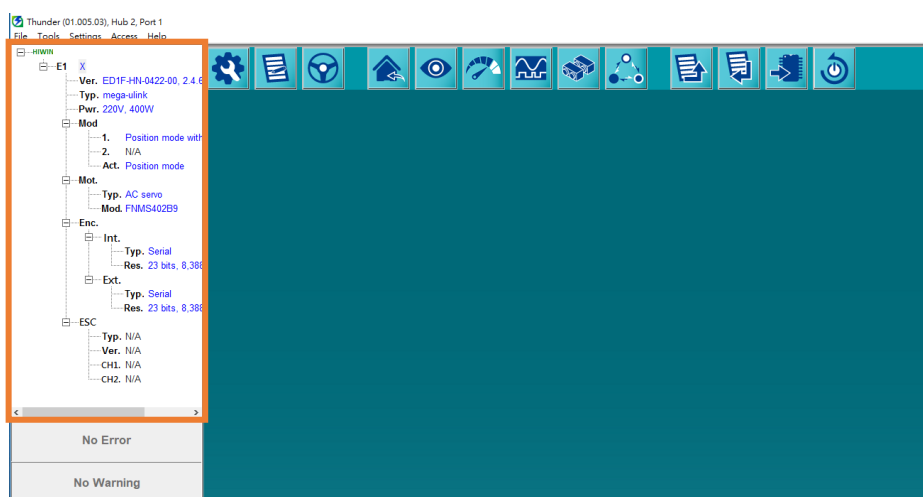

Figure 7.2.1

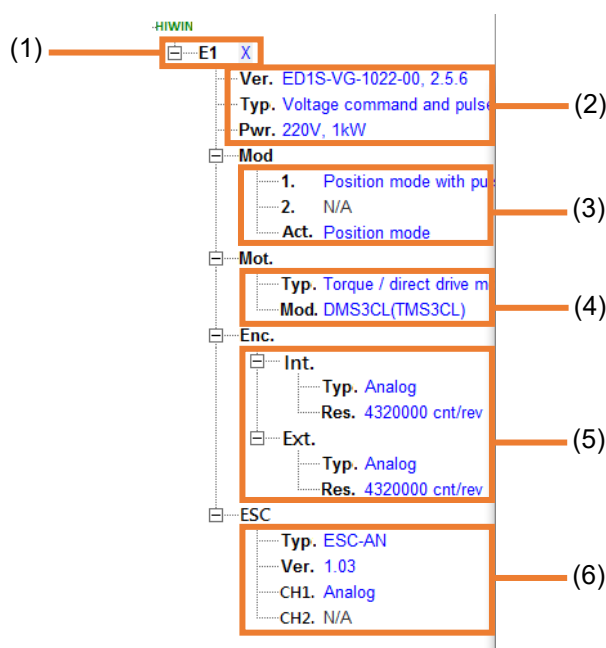

Figure 7.2.2

Table 7.2.1

No.	Item	Description
(1)	Axis name of servo drive	Servo drive's axis name; right-click axis name to modify axis name.
(2)	Specifications of servo drive	Ver.: Servo drive model and firmware version. Typ.: Type for servo drive to receive commands from host. Pwr.: Servo drive frame and power output.
(3)	Control mode	Display control mode setting and the current control mode.
(4)	Information of motor	Typ.: Motor type. Mod.: Motor model.
(5)	Information of encoder	Int.: Information of internal encoder. Ext.: Information of external encoder. Typ.: Encoder type. Res.: Encoder resolution.
(6)	Information of ESC	Typ.: ESC type. Ver.: ESC firmware version. CH1: Encoder format of ESC channel 1. CH2: Encoder format of ESC channel 2.

7.3 Monitor servo drive's signal status

Users can get servo drive's real-time signal status. The items can be monitored are as below.

- ◆ The voltage of main power cable
- ◆ The current of motor
- ◆ Input commands and input signals
- ◆ Output values and output signals
- ◆ Information of encoder
- ◆ Information of ESC
- ◆ Communication status of gantry control system

Follow the procedure below to open "Interface signal monitor" window.

1. Click "Open Interface signal monitor" icon in the toolbar to open "Interface signal monitor" window.

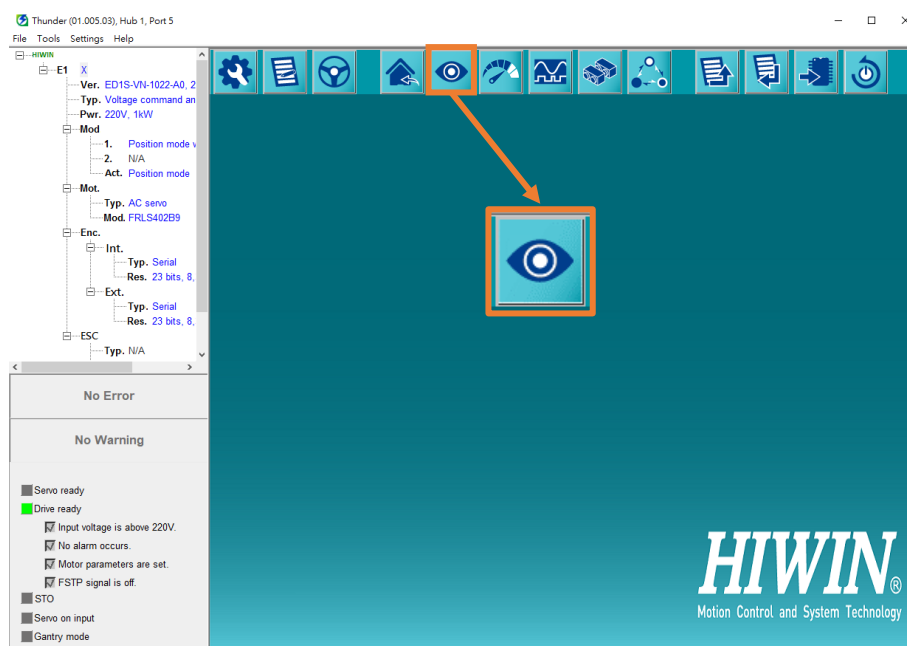

Figure 7.3.1

2. Display window is determined by "servo drive model" and "the usage of ESC".

■ Standard servo drive

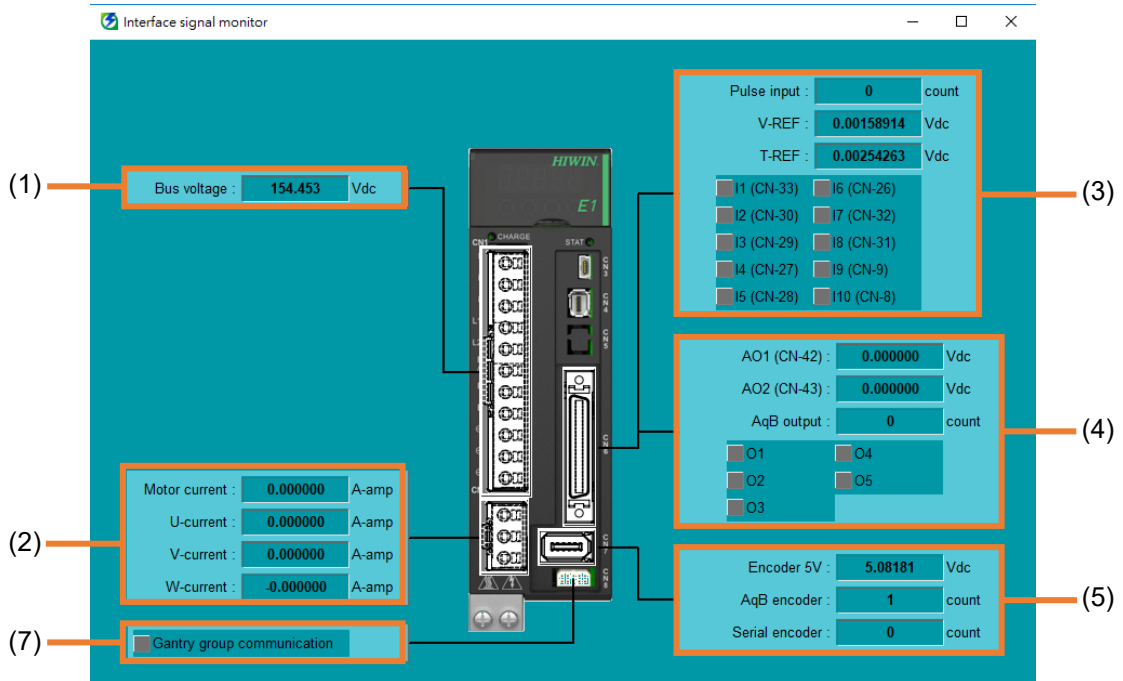

Figure 7.3.2

■ Standard servo drive – with ESC

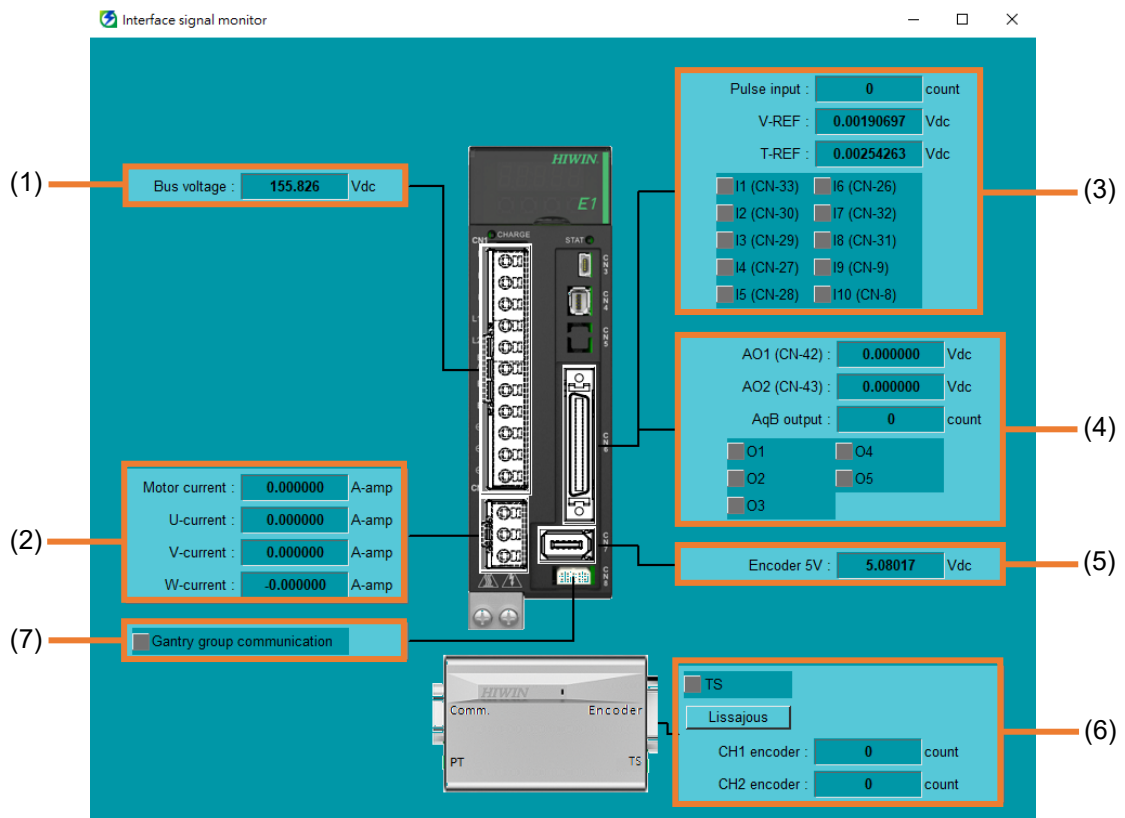

Figure 7.3.3

■ Fieldbus servo drive

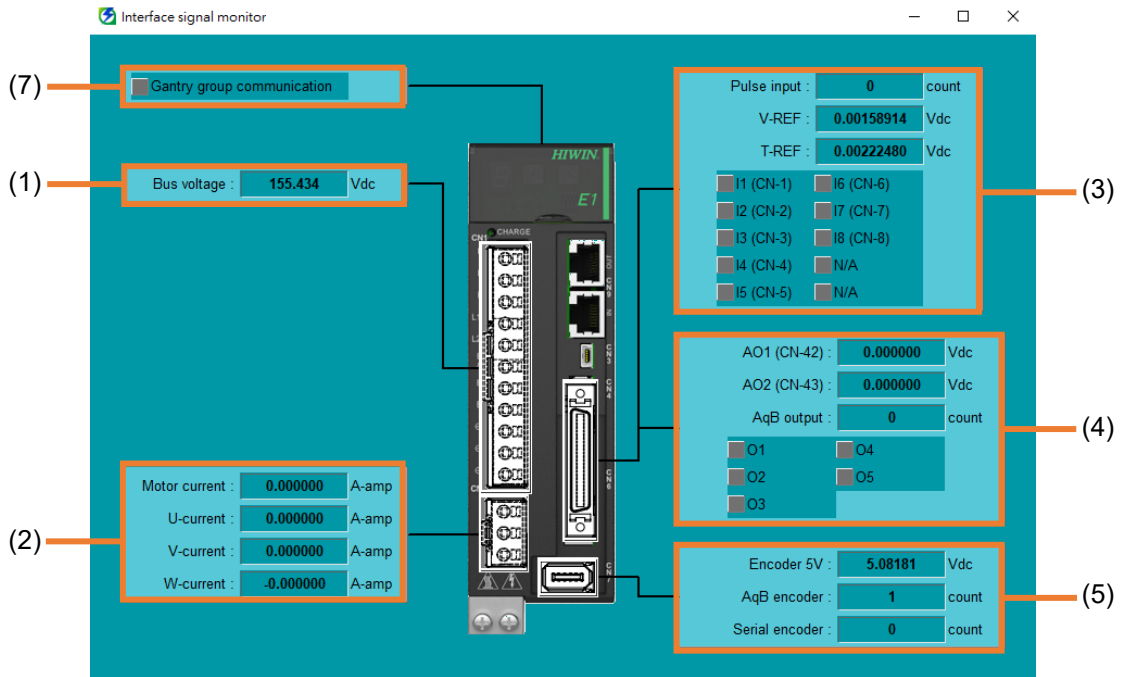

Figure 7.3.4

■ Fieldbus servo drive – with ESC

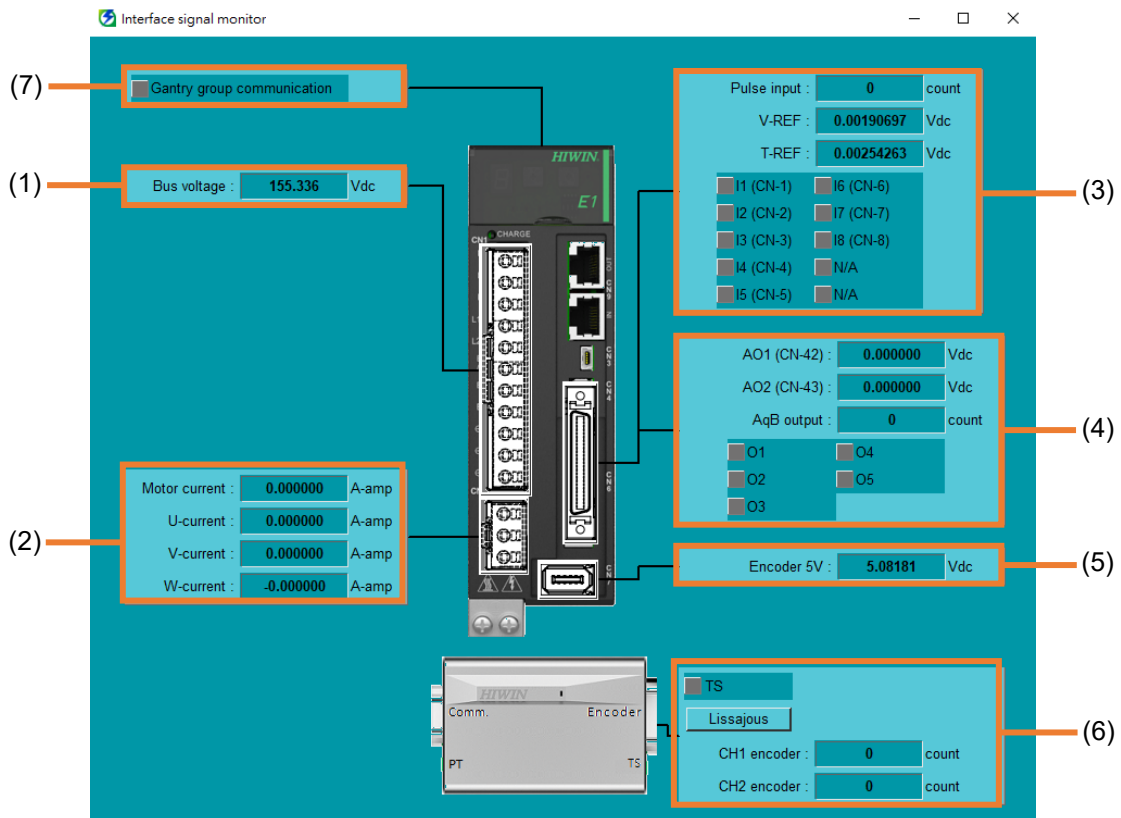





Figure 7.3.5

Table 7.3.1

No.	Item	Description	Reference for wiring
(1)	The voltage of main power cable	Real-time voltage of servo drive.	section 5.3 in “E1 Series Servo Drive User Manual”
(2)	The current of motor	Real-time current of motor and three-phase current (U, V, W).	section 5.4.2 in “E1 Series Servo Drive User Manual”
(3)	Input commands and input signals	<p>Pulse command and voltage command received by servo drive.</p> <p>Input signal status of servo drive.</p> <div style="display: flex; align-items: center;">  <div> <p>Information</p> <ol style="list-style-type: none"> 1. Input signals for standard servo drive are I1~I10; while input signals for Fieldbus servo drive are I1~I8. 2. Fieldbus servo drive does not support pulse command and voltage command. </div> </div>	section 5.5 in “E1 Series Servo Drive User Manual”
(4)	Output values and output signals	Real-time analog output and pulse output of servo drive. Output signal status of servo drive.	section 5.5 in “E1 Series Servo Drive User Manual”
(5)	Information of encoder	Real-time 5Vdc voltage of encoder. Feedback of incremental and serial encoder.	section 5.4.3 in “E1 Series Servo Drive User Manual”
(6)	Information of ESC	<p>TS is the detection signal for over temperature. When the motor is over temperature, the light remains red.</p> <p>Lissajous allows users to observe the current information of analog encoder.</p> <p>When servo drive is used with ESC, users can monitor the feedback of CH1 encoder and CH2 encoder.</p> <div style="display: flex; align-items: center;">  <div> <p>Information</p> <ol style="list-style-type: none"> 1. This item will be displayed only if users check Activate smart cube in Configuration Wizard. 2. Lissajous will be displayed only if analog encoder is used. </div> </div>	chapter 3 in “E1 Series Servo Drive User Manual”

<p>(7)</p>	<p>Communication status of gantry control system</p>	<p>The light remains green when servo drive is in gantry control system.</p> <p> This item will be displayed only if gantry model servo drive (ED1□-□G-□□□□-□□) is used.</p>	<p>chapter 1 in “E1 Series Servo Drive Gantry Control System User Manual”</p>
------------	--	---	---

7.3.1 Lissajous

Lissajous allows users to observe the waveform of analog encoder feedback signal. If the waveform is a circle during motor rotation, the signal is normal.



Important

If the Lissajous function is applicable, its button will show up.

Follow the procedure below to open “Lissajous” window.

1. Click **Lissajous**.

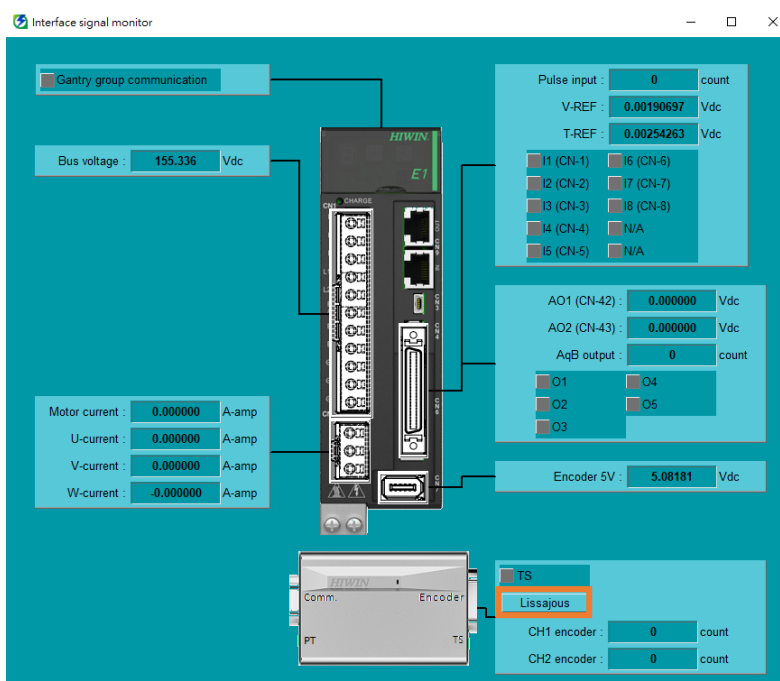

Figure 7.3.1.1

2. Open “Lissajous” window.

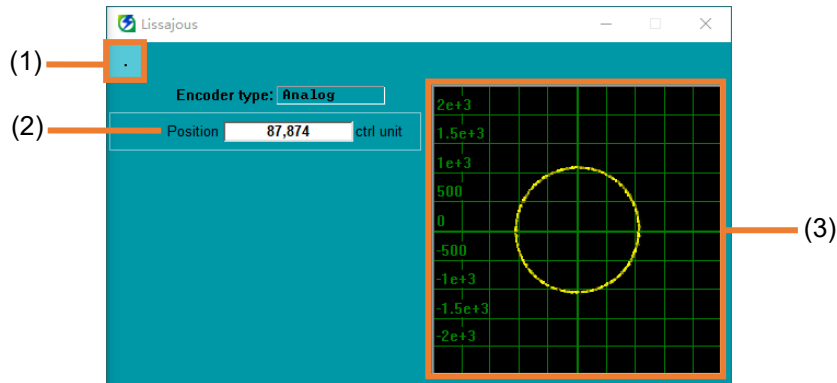

Figure 7.3.1.2

Table 7.3.1.1

No.	Item	Description	Reference
(1)	Set the window to the top	Users can set “Lissajous” window to the top. If the button displays T , the window is on the top. If the button displays . , the window is not on the top.	--
(2)	Motor feedback	Real-time feedback position of motor.	--
(3)	Waveform display area	The waveform of analog encoder feedback signal is displayed here.	section 7.3.1.1

7.3.1.1 Waveform display area

Right-click waveform display area to perform display setting.

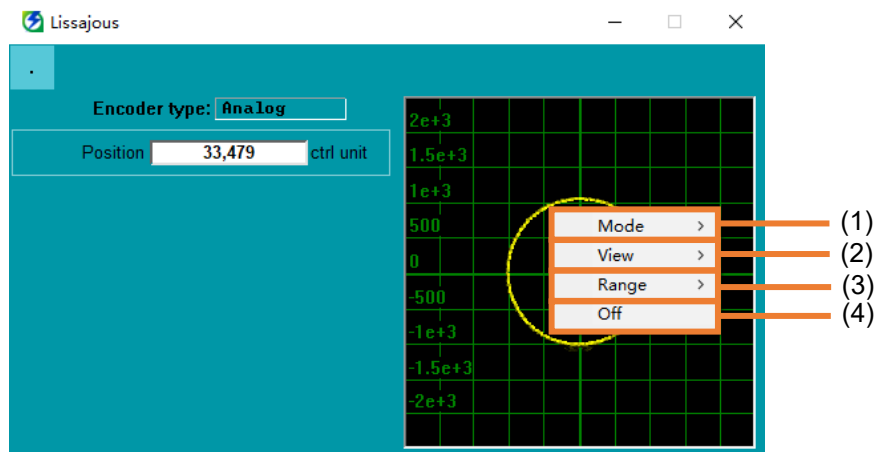

Figure 7.3.1.1.1

Table 7.3.1.1.1

No.	Item	Reference
(1)	Mode	Mode
(2)	View	View
(3)	Range	Range
(4)	Off	Off

■ Mode

1. Click **Limit rate** to open the window for adjusting the maximum sample rate.

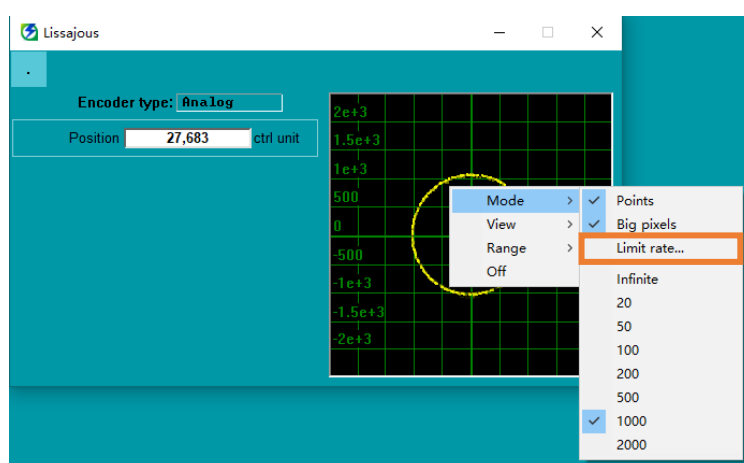

Figure 7.3.1.1.2

2. Key in the maximum sample rate, and click **Apply**.

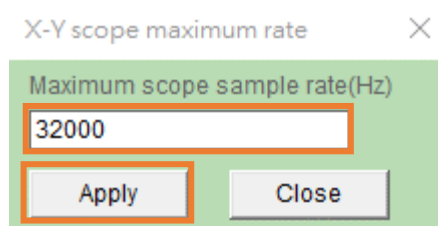

Figure 7.3.1.1.3

3. Besides, users can select the time that the waveform stays (Unit: ms).

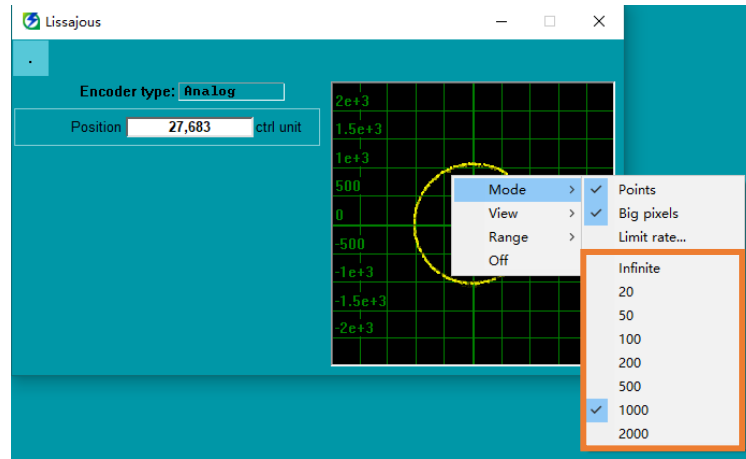

Figure 7.3.1.1.4

■ View

1. Click **Window** to separate waveform display area from the window.

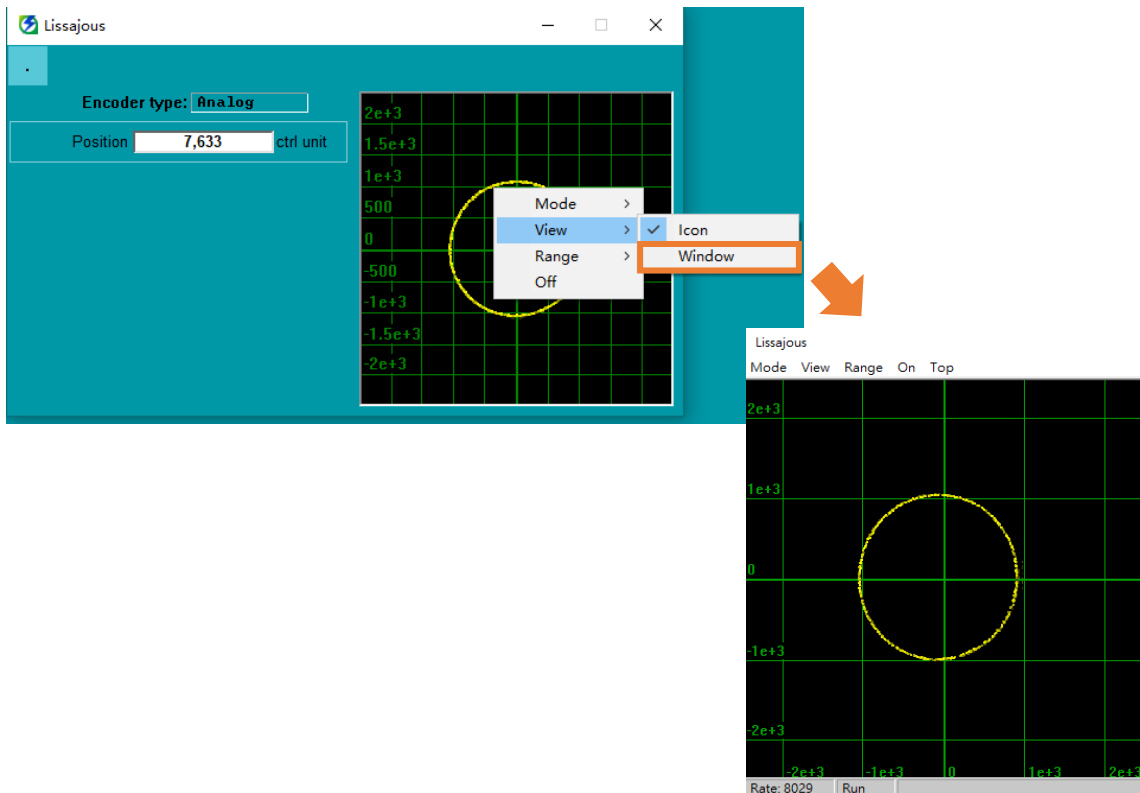

Figure 7.3.1.1.5

2. Click **Icon** to put waveform display area back to the window.

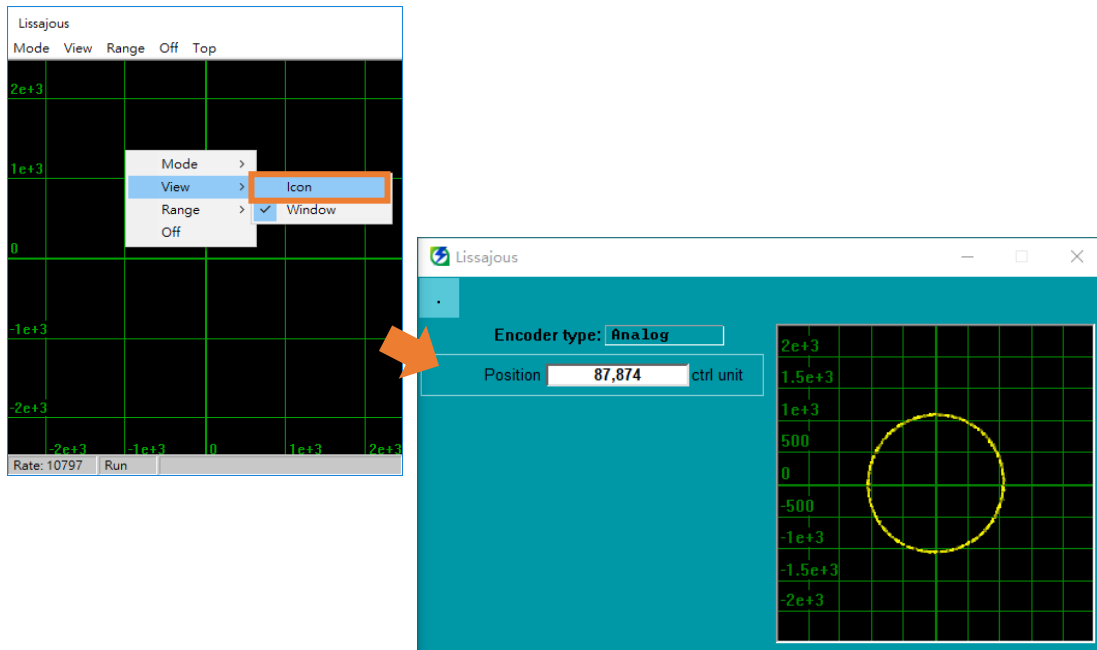

Figure 7.3.1.1.6

■ Range

Click **Range** to modify waveform display scale.

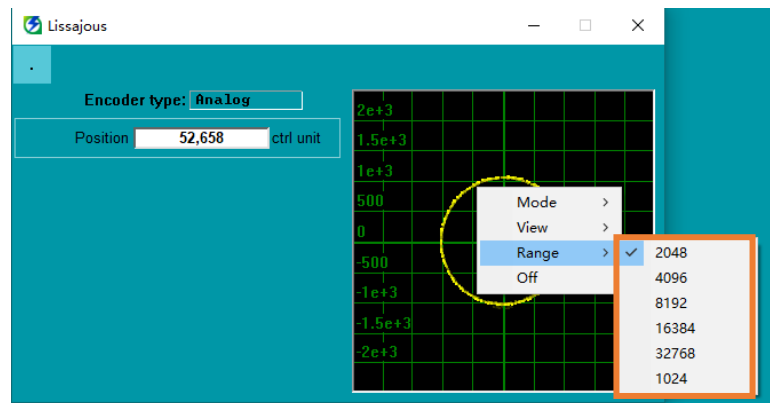

Figure 7.3.1.1.7

■ Off

1. Click **Off** to close waveform display.

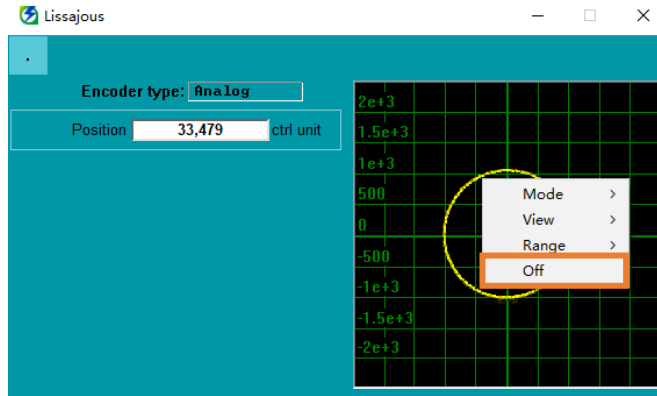

Figure 7.3.1.1.8

2. Click **On** to activate waveform display.

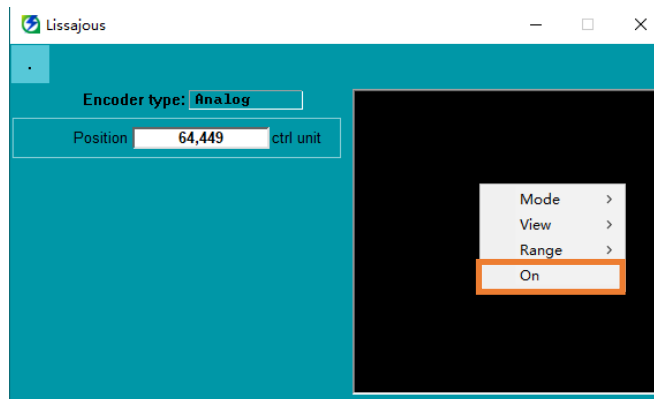

Figure 7.3.1.1.9

7.4 Performance monitor

Users can adjust some motion parameters, and observe motor motion's status and performance in real-time. Follow the procedure below to open "Performance monitor" window.

1. Click "Open performance monitor" icon in the toolbar.

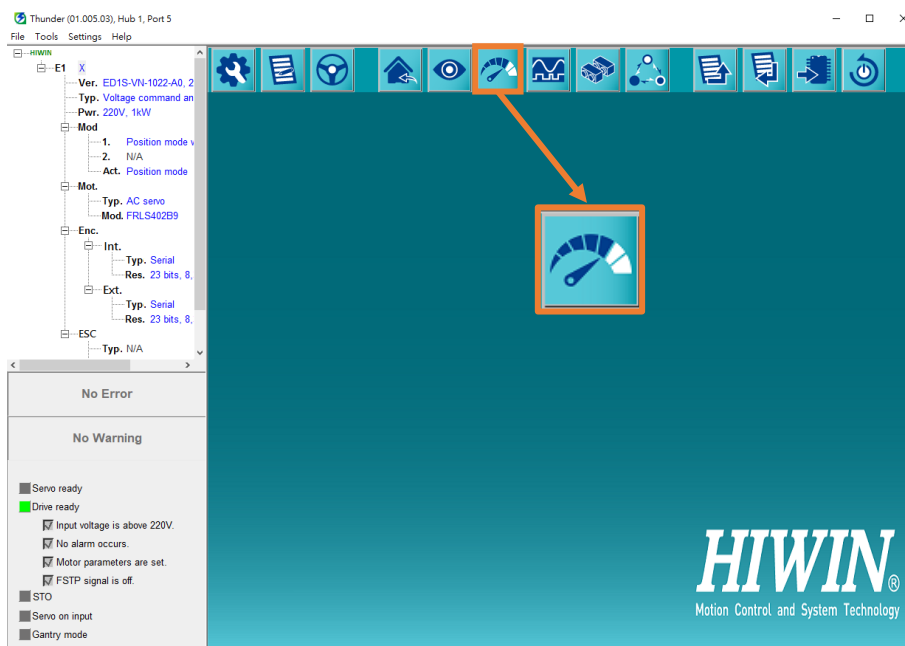

Figure 7.4.1

2. Open "Performance monitor" window.

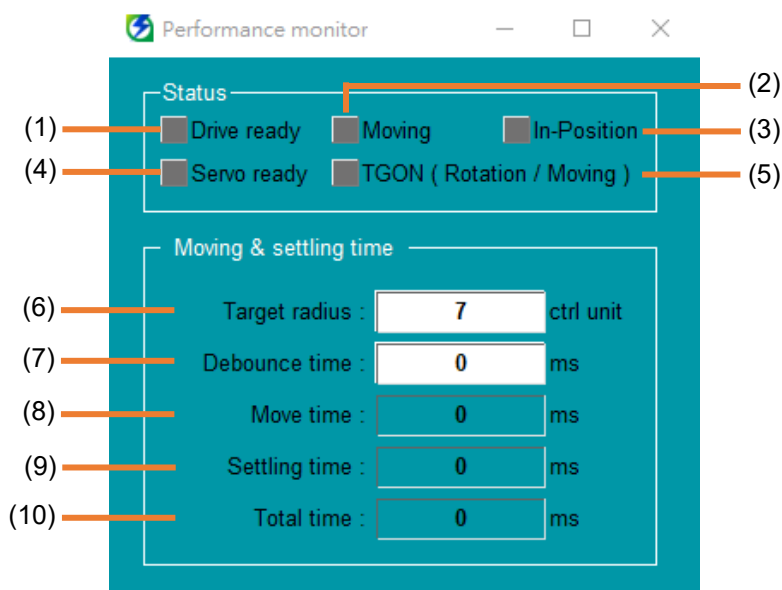

Figure 7.4.2

Table 7.4.1

No.	Item	Description	Reference
(1)	Drive ready	When it lights up in green, the servo drive is ready.	--
(2)	Moving	When it lights up in green, the motor is moving.	--
(3)	In-Position	When it lights up in green, the motor reaches the position.	--
(4)	Servo ready	Display whether the motor is enabled. If it lights up in green after the motor is enabled, servo is ready.	--
(5)	TGON (Rotation / Moving)	Rotation signal detection; when it lights up in green, TGON signal is triggered.	section 8.1.7 in "E1 Series Servo Drive User Manual"
(6)	Target radius	Set positioning completion width (Pt522).	section 8.4.4 in "E1 Series Servo Drive User Manual"
(7)	Debounce time	Set debounce time (Pt523).	section 8.4.4 in "E1 Series Servo Drive User Manual"
(8)	Move time	Display the time when the command is sent to the command ends.	section 8.4.4 in "E1 Series Servo Drive User Manual"
(9)	Settling time	Display the time when the command ends to the motor is in-position.	section 8.4.4 in "E1 Series Servo Drive User Manual"
(10)	Total time	Display the time when the motor starts moving to the motor is in-position.	section 8.4.4 in "E1 Series Servo Drive User Manual"

7.5 Scope

Users can get servo drive's physical quantity and signal waveform without using measuring instrument. It is suitable for short term monitoring. When the signal is triggered, users can immediately observe the change or the transition of the monitoring item for further operation.

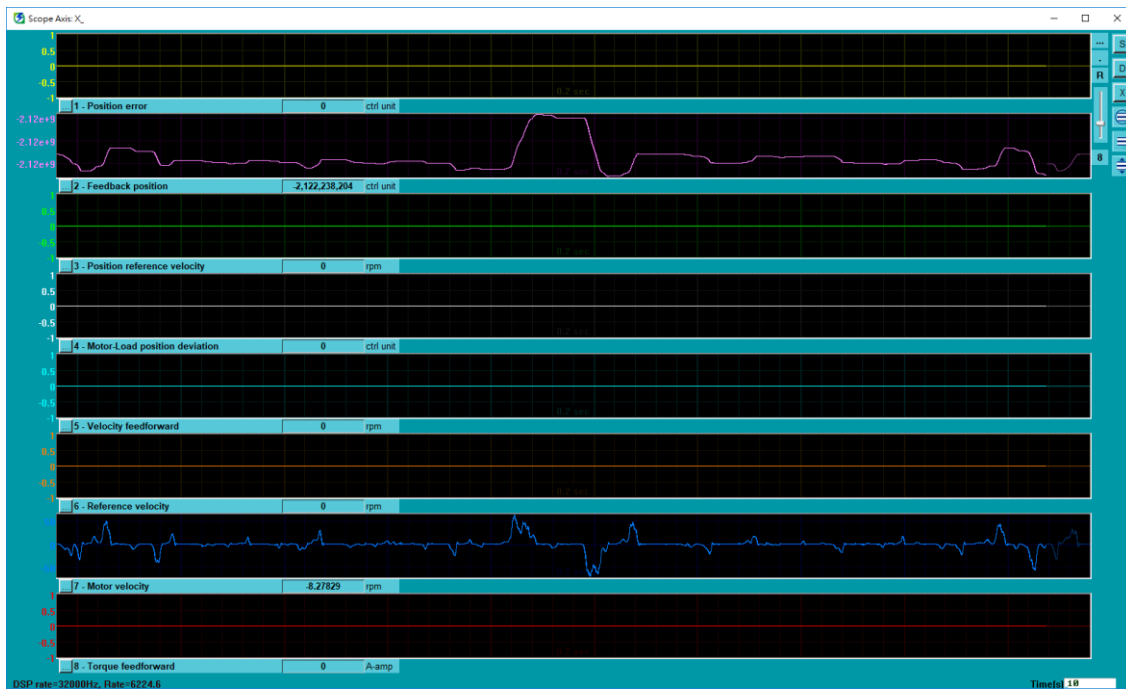

Figure 7.5.1



Important

The update speed of Scope will be affected by the performance of the computer.

Follow the procedure below to open “Scope” window.

1. Click “Open Scope” icon in the toolbar.

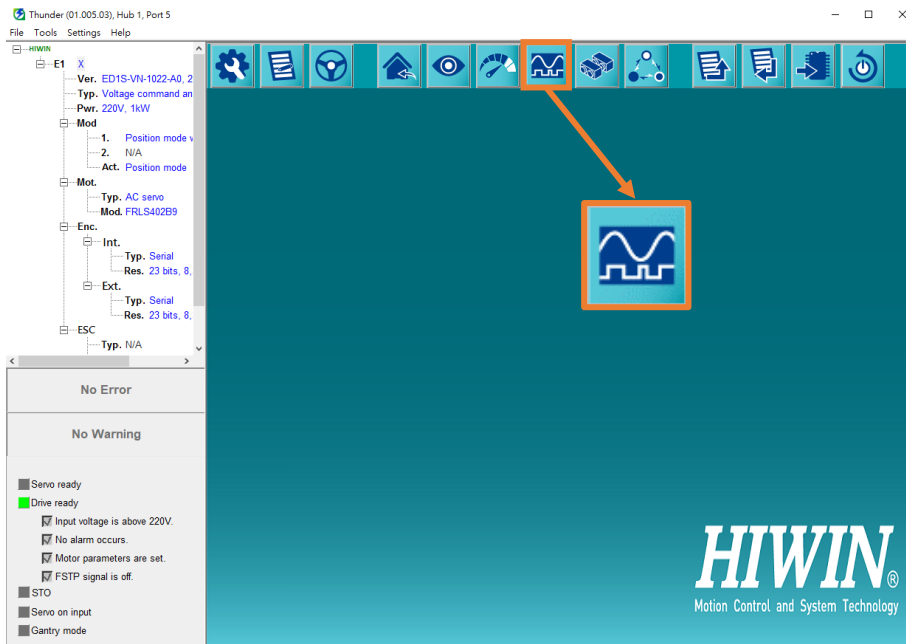

Figure 7.5.2

2. Open “Scope” window.

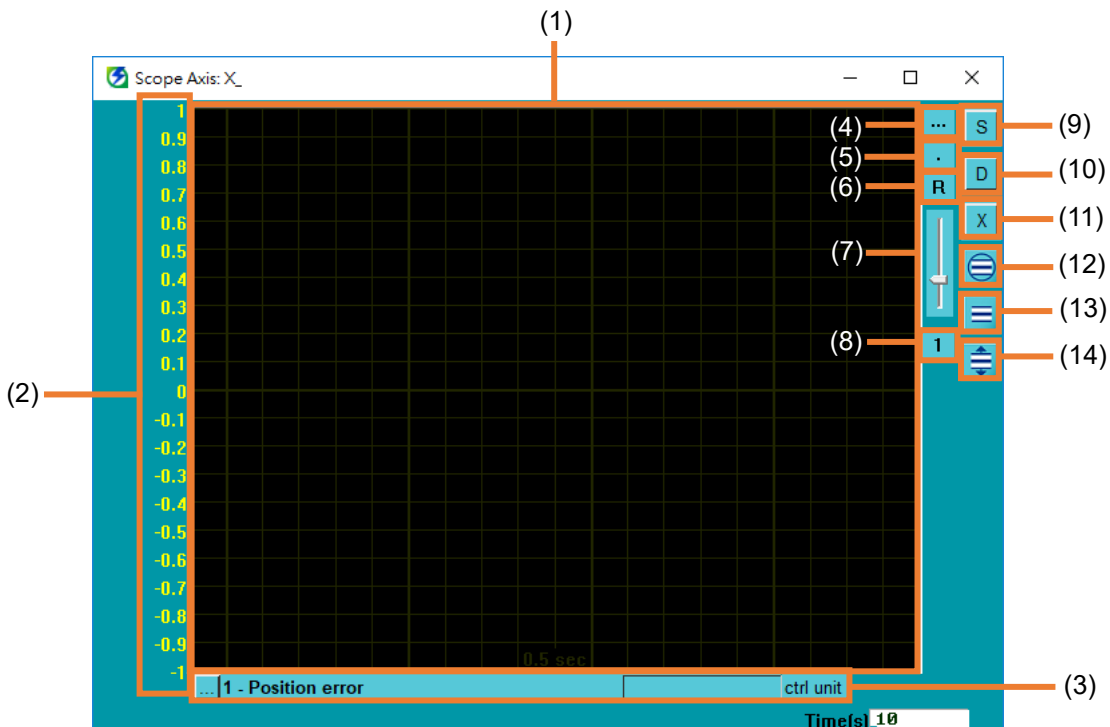





Figure 7.5.3

Table 7.5.1

No.	Item	Description	Reference
(1)	Waveform display area	The waveform of monitoring item is displayed here.	--
(2)	Waveform display scale	The scale will automatically change due to the waveform in the display range. Users can adjust the scale setting with button (12), (13) and (14).	--
(3)	Current monitoring item	Users can select the desired monitoring item with the drop-down menu.	section 7.5.1 section 7.5.7
(4)	Start scope with pre defined variables/scenarios	Set the monitoring items in channel 1 and channel 2 as the default.	section 7.5.2
(5)	Put scope always in top	Users can set "Scope" window to the top. If the button displays  , the window is on the top. If the button displays  , the window is not on the top.	--
(6)	Fix range/Auto range setup (Adjust the size of waveform display scale)	Users can set the maximum and the minimum value of waveform display scale.	section 7.5.3
(7)	Grid light	Users can adjust the grid light of Scope.	section 7.5.4
(8)	Set number of scope channels	Users can set the number of channels monitored by Scope.	section 7.5.5
(9)	Start or pause waveform monitoring	Users can start or pause waveform monitoring.	section 7.5.6
(10)	Open real-time data collection window	Users can open "Real-time data collection" window.	section 7.6
(11)	Close "Scope" window	Click the button to close "Scope" window.	--
(12)	Fit graph to window	Click the button to fix the current scale range.	--
(13)	Fit graph to window dynamically	Click the button to make the scale automatically change due to the waveform in the display range.	--
(14)	Fit graph to window dynamically + clip	Click the button to make the scale automatically change due to the maximum and the minimum value of waveform.	--

7.5.1 Current monitoring item

Follow the procedure below to select the desired monitoring item.

After clicking , drag the scroll bar to select the desired monitoring item.

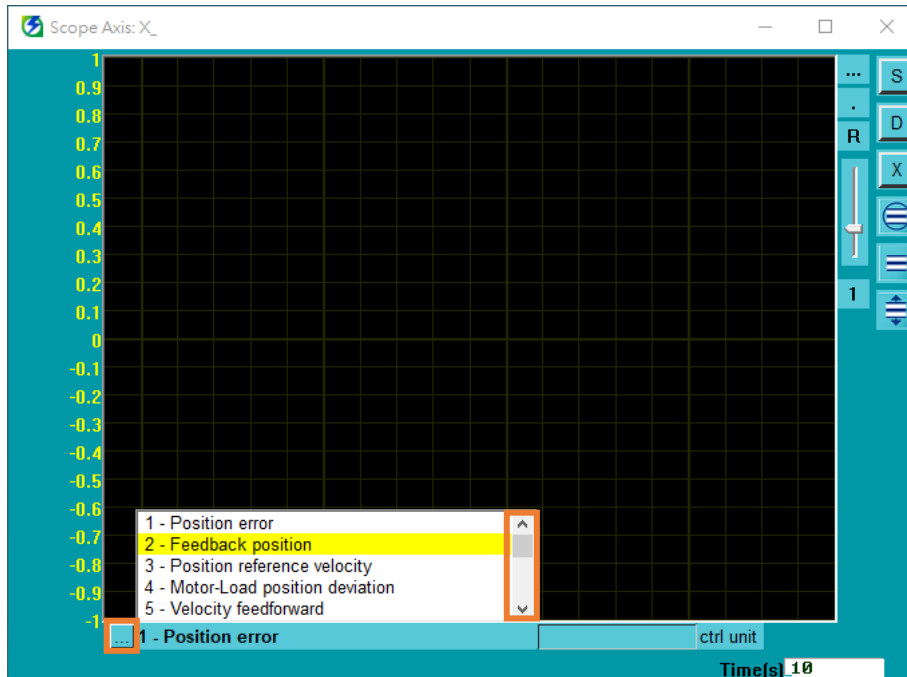

Figure 7.5.1.1

7.5.2 Start scope with pre defined variables/scenarios

Follow the procedure below to set the monitoring items in channel 1 and channel 2 as the default.

1. Click “Start scope with pre defined variables/scenarios” icon.

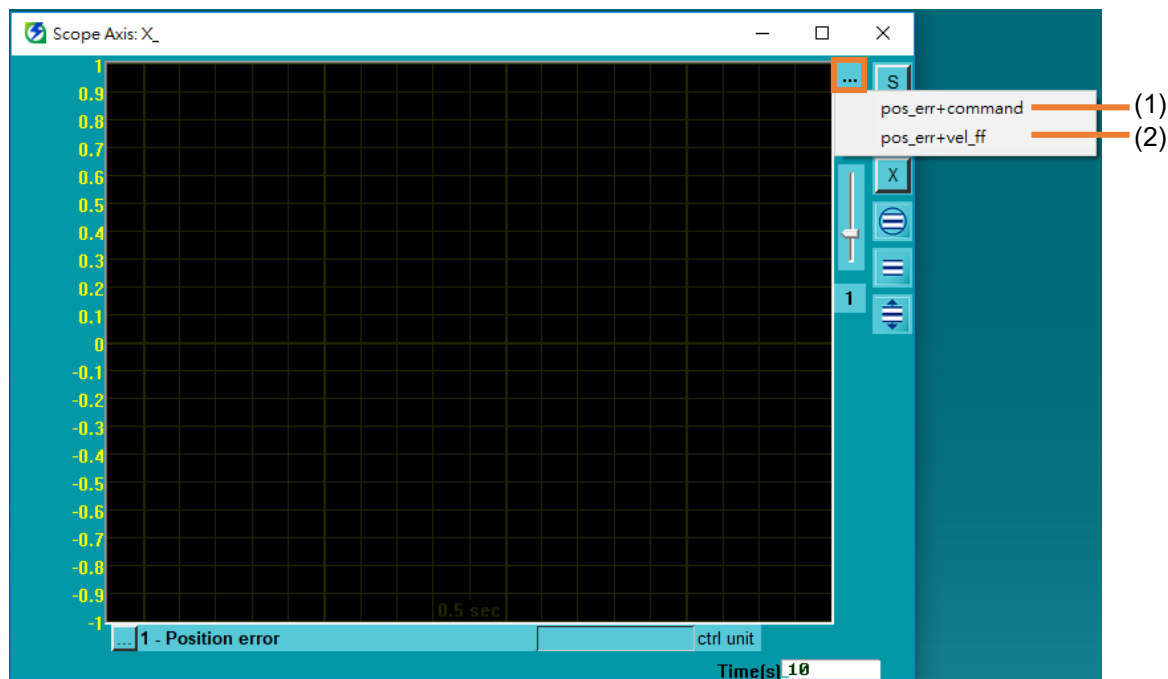

Figure 7.5.2.1

Table 7.5.2.1

No.	Item	Description
(1)	pos_err+command	Set monitoring item in channel 1 as 1-Position error and set monitoring item in channel 2 as 10-Command current .
(2)	pos_err+vel_ff	Set monitoring item in channel 1 as 1-Position error and set monitoring item in channel 2 as 5-Velocity feedforward .

2. Click **pos_err+command**. Set monitoring item in channel 1 as **1-Position error** and set monitoring item in channel 2 as **10-Command current**.

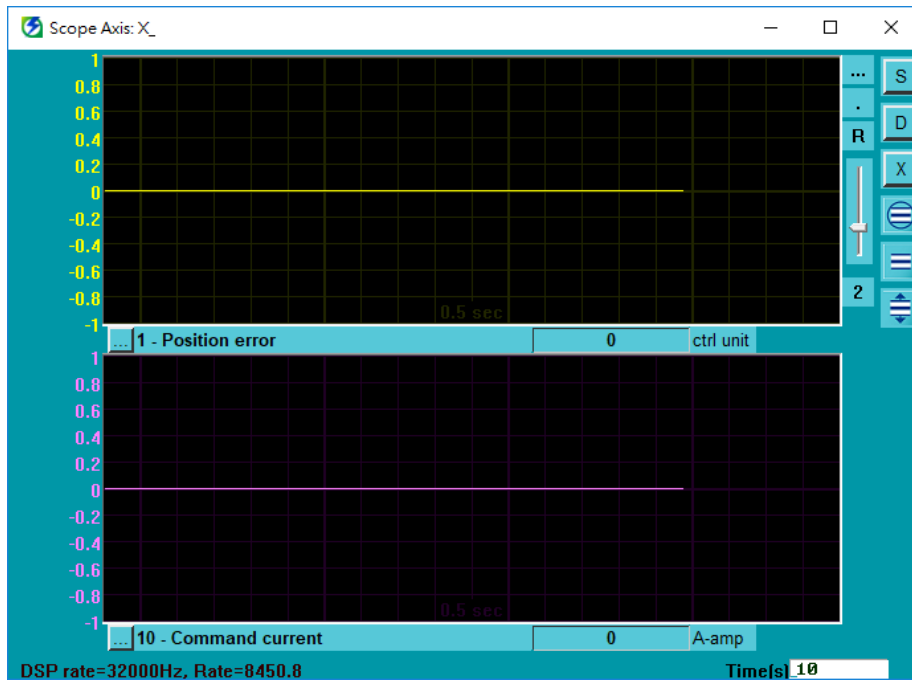

Figure 7.5.2.2

3. Click **pos_err+vel_ff**. Set monitoring item in channel 1 as **1-Position error** and set monitoring item in channel 2 as **5-Velocity feedforward**.

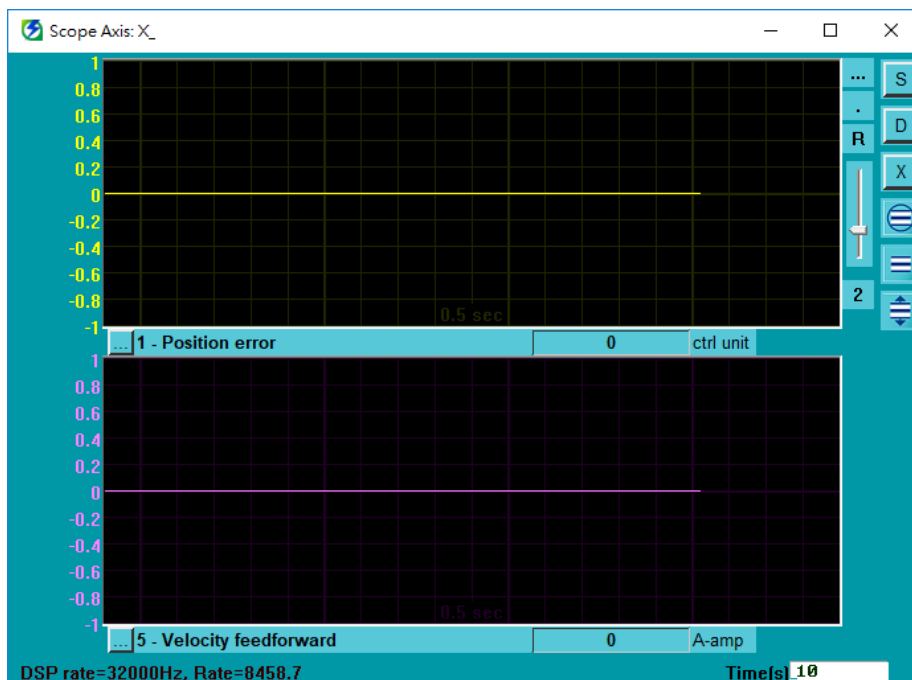

Figure 7.5.2.3

7.5.3 Fix range/Auto range setup

Follow the procedure below to set the maximum and the minimum value of waveform display scale.

1. Click “Fix range/Auto range setup” icon.

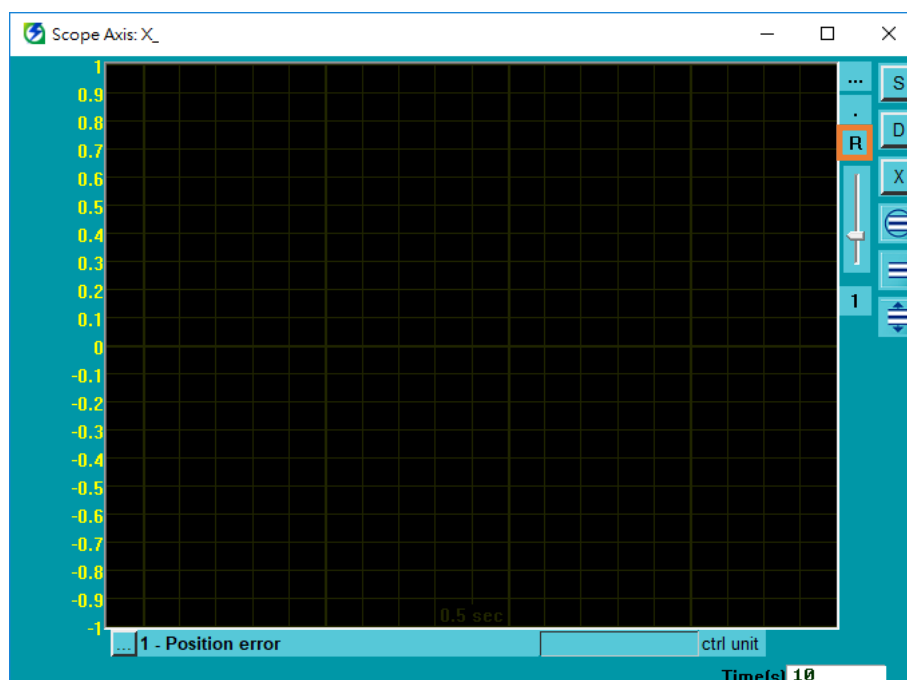

Figure 7.5.3.1

2. Check **Fix range** and key in the desired values in “Max” and “Min” column. “Max” represents the maximum value of scale, while “Min” represents the minimum value of scale.

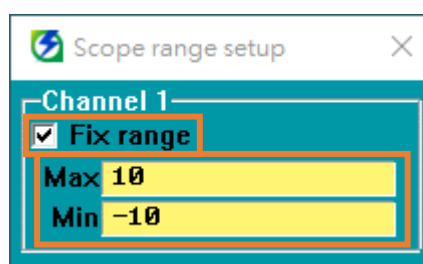

Figure 7.5.3.2

3. After step 2 is done, waveform display scale will change accordingly.

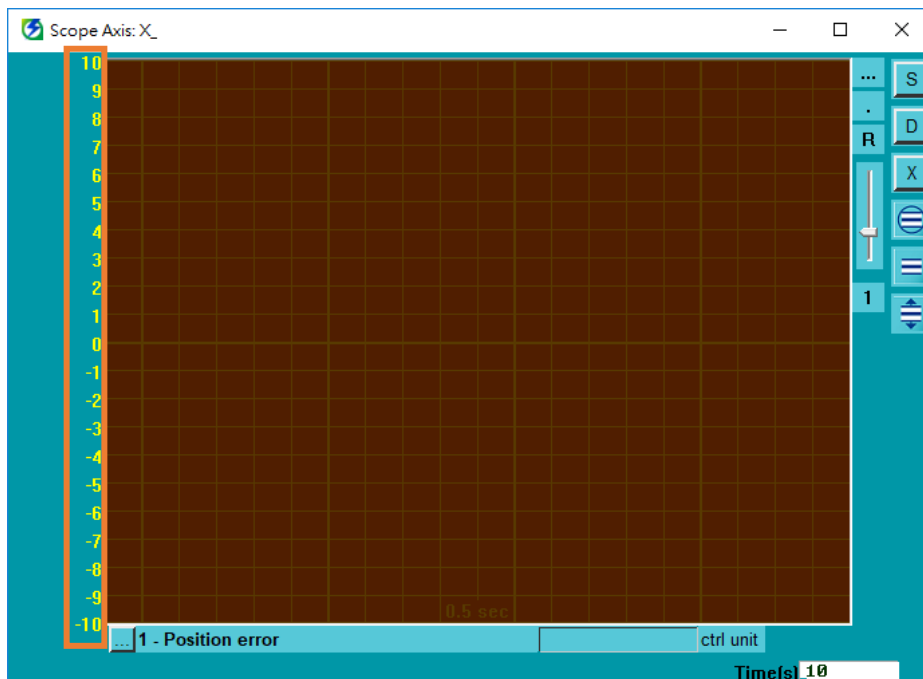

Figure 7.5.3.3

7.5.4 Grid light

Follow the procedure below to adjust the grid light of Scope.

Drag the scroll bar. Drag it up to deepen the grid; drag it down to lighten the grid.

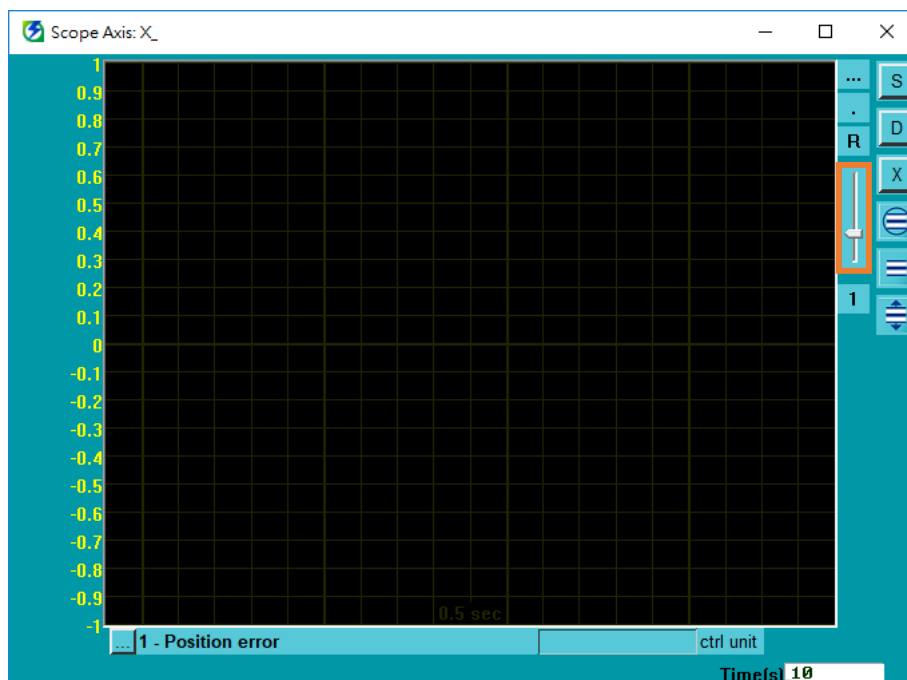

Figure 7.5.4.1

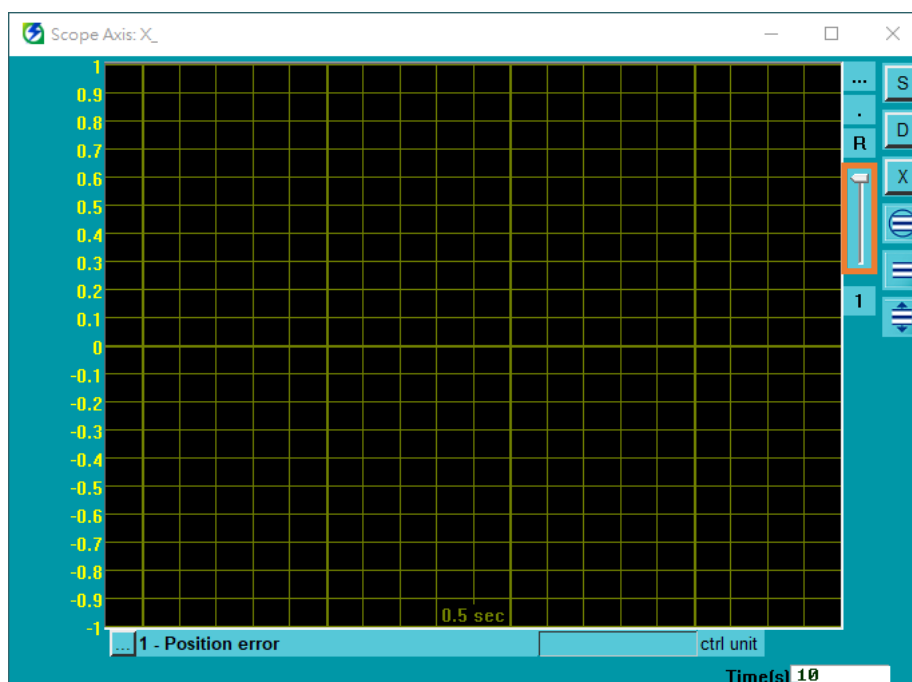

Figure 7.5.4.2

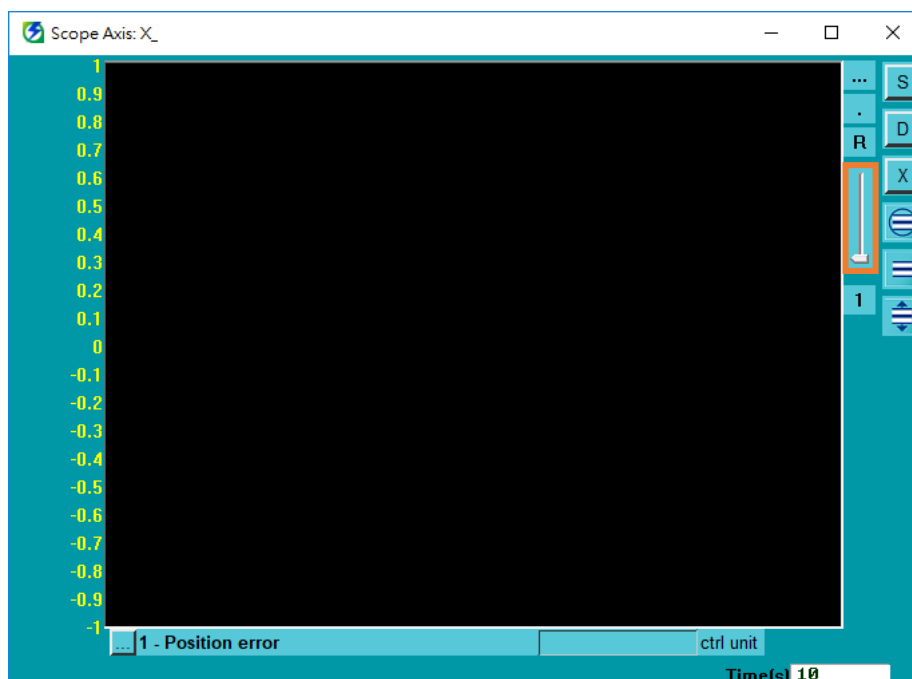

Figure 7.5.4.3

7.5.5 Set number of scope channels

Users can set the number of channels monitored by Scope. Scope can support up to 8 channels at the same time. Follow the procedure below to set the number of channels monitored by Scope.

1. Click “Set number of scope channels” icon to open the menu for number of channels.

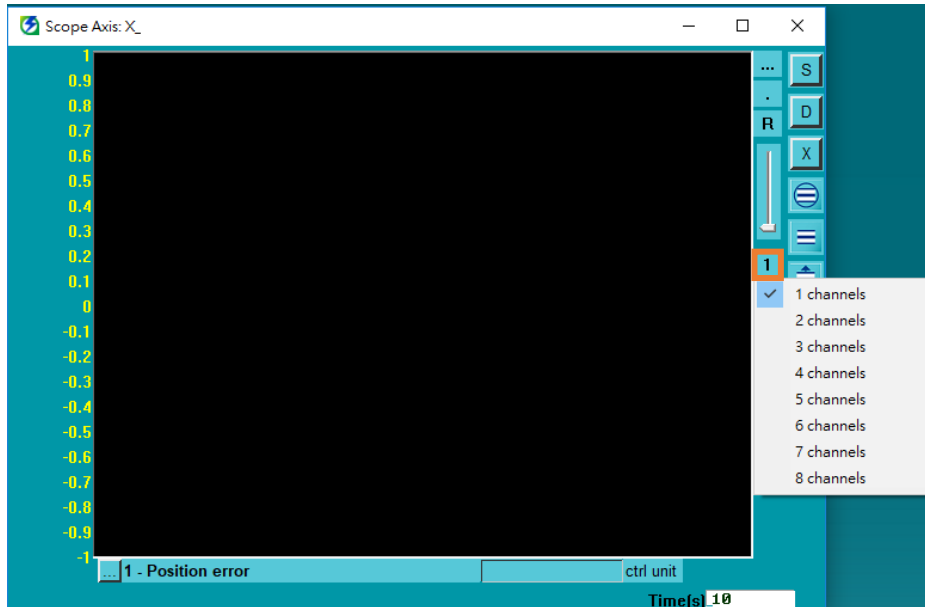

Figure 7.5.5.1

2. Select number of channels.

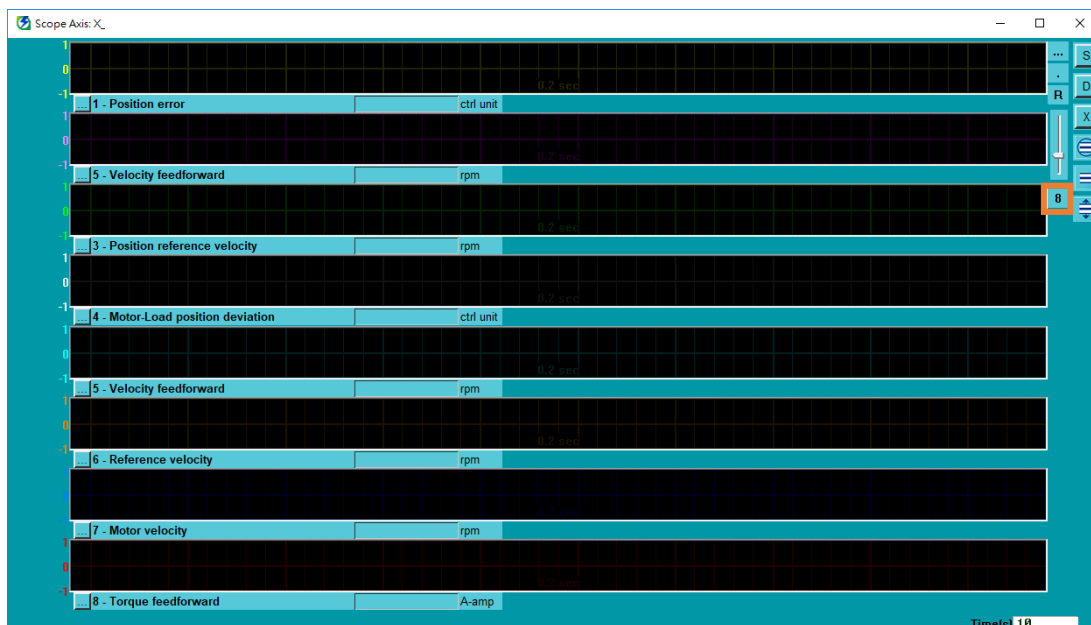



Figure 7.5.5.2

7.5.6 Start or pause waveform monitoring

Follow the procedure below to start or pause waveform monitoring.

1. Click  to start waveform monitoring.

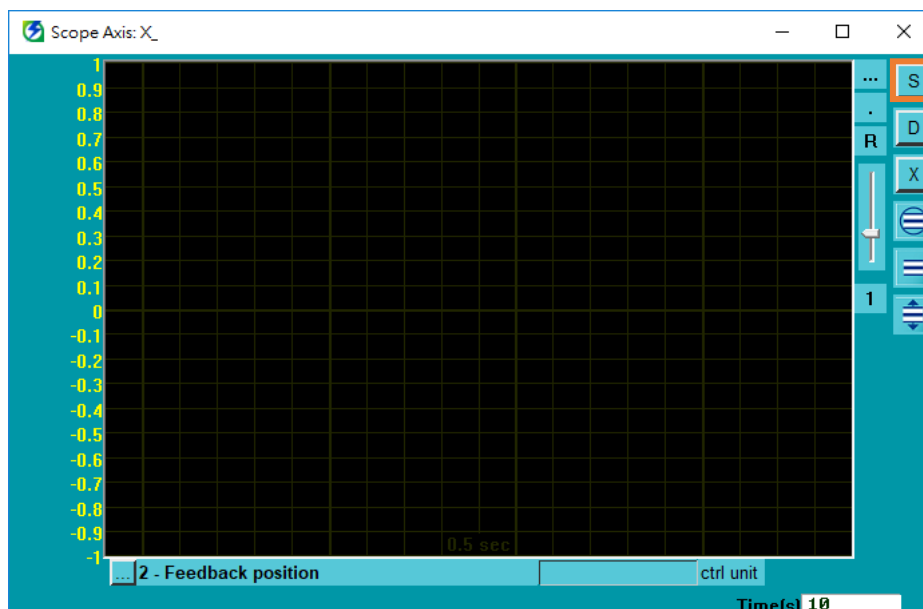

Figure 7.5.6.1

2. Waveform monitoring starts.

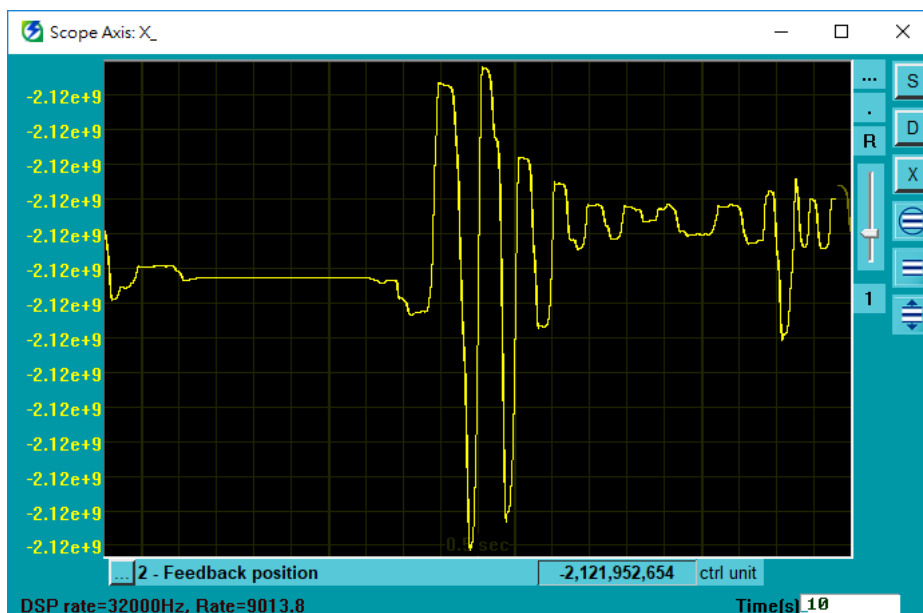

Figure 7.5.6.2

3. Click **S** to pause waveform monitoring. The waveform will stop at the moment the button is clicked.

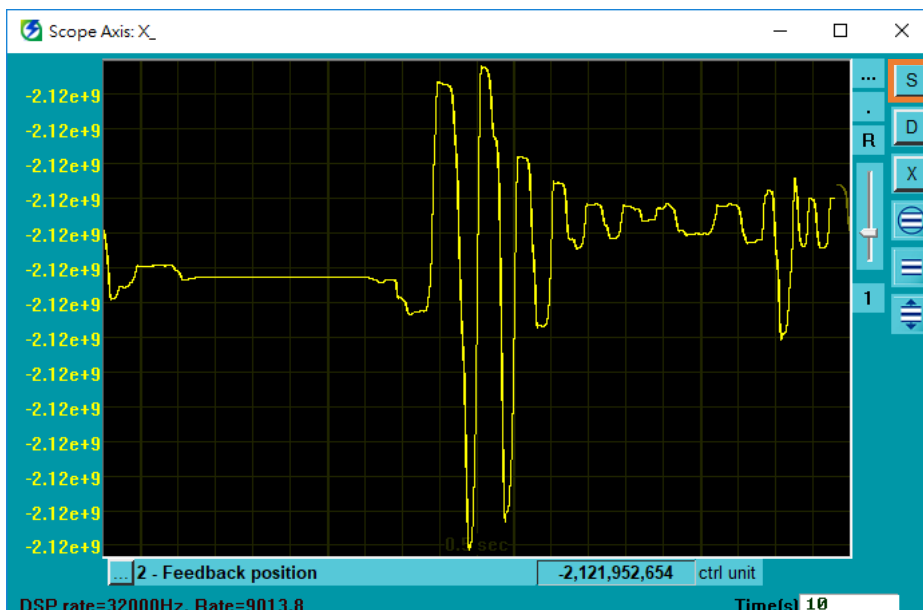

Figure 7.5.6.3

7.5.7 Monitoring items

The items can be monitored by Scope are listed in the following table.

Table 7.5.7.1

Monitoring items	
Physical quantity	Servo signal status
(1) Position error	(51) S-ON //servo on input signal
(2) Feedback position	(52) P-CON //proportional control input signal
(3) Position reference velocity	(53) P-OT //forward prohibition input signal
(4) Motor-Load position deviation	(54) N-OT //reverse prohibition input signal
(5) Velocity feedforward	(55) ALM-RST //alarm reset input signal
(6) Reference velocity	(56) P-CL //forward external torque limit input signal
(7) Motor velocity	(57) N-CL //reverse external torque limit input signal
(8) Torque feedforward	(58) C-SEL //control method switching input signal
(9) Torque reference	(59) SPD-D //motor rotation direction input signal
(10) Command current	(60) SPD-A //internal set velocity input signal
(11) Motor current	(61) SPD-B //internal set velocity input signal
(12) Servo voltage percentage	(62) ZCLAMP //zero clamp input signal
(13) Digital hall signal	(63) INHIBIT //command pulse inhibition input signal
(14) Motor overload protection	(64) G-SEL //gain switching input signal
(15) Position amplifier error	(65) PSEL //command pulse multiplication switching input signal

(16) Velocity error	(66) RST //servo drive reset input signal
(17) Master feedback position	(67) DOG //near home sensor input signal
(18) Slave feedback position	(68) HOM //servo drive built-in homing procedure input signal
(19) Yaw position	(69) MAP //servo drive error map input signal
(20) Run position command	(70) FSTP //forced stop input signal
(21) Effective gain	(71) CLR //position deviation clear input signal
(22) Internal feedback position	(72) ALM //alarm output signal
(23) Gantry linear command current	(73) COIN //positioning completion output signal
(24) Gantry yaw command current	(74) V-CMP //velocity reach output signal
(25) Gantry yaw position error	(75) TGON //rotation detection/movement detection output signal
	(76) D-RDY //drive ready output signal
	(77) S-RDY //servo ready output signal
	(78) CLT //torque limit detection output signal
	(79) VLT //velocity limit detection output signal
	(80) BK //brake control output signal
	(81) WARN //warning output signal
	(82) NEAR //positioning near output signal
	(83) PSELA //command pulse multiplication switching output signal
	(84) PT //position trigger digital output signal
	(85) DBK //external dynamic brake output signal
	(86) HOMED //servo drive homing completion output signal
	(87) PAO //encoder divided pulse output signal-A phase
	(88) PBO //encoder divided pulse output signal-B phase
	(89) PZO //encoder divided pulse output signal-Z phase
	(90) INDEX //index signal



Information

(17) Master feedback position, (18) Slave feedback position and (19) Yaw position can only be monitored when gantry model servo drive (ED1□-□G-□□□□-□□) is used.

7.6 Real-time data collection

Users can record servo drive’s physical quantity and signal waveform for a period of time, and save them as a file (*.gpp) for observation. Real-time data collection provides start event and stop event for collection. Users can trigger or modify the event to record waveform.

There are two ways to open “Real-time data collection” window:

- ◆ Method 1: Select **Tools** in the menu bar and click **Real-time data collection**.

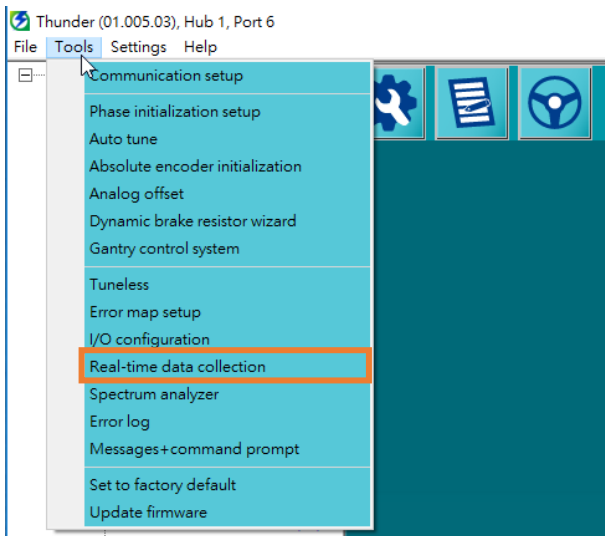

Figure 7.6.1

- ◆ Method 2: Click .

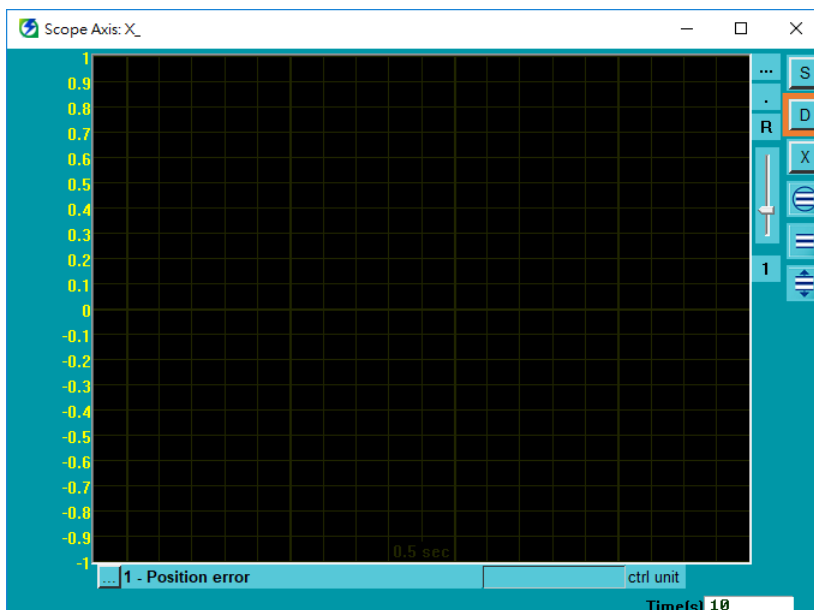

Figure 7.6.2

7.6.1 Interface introduction

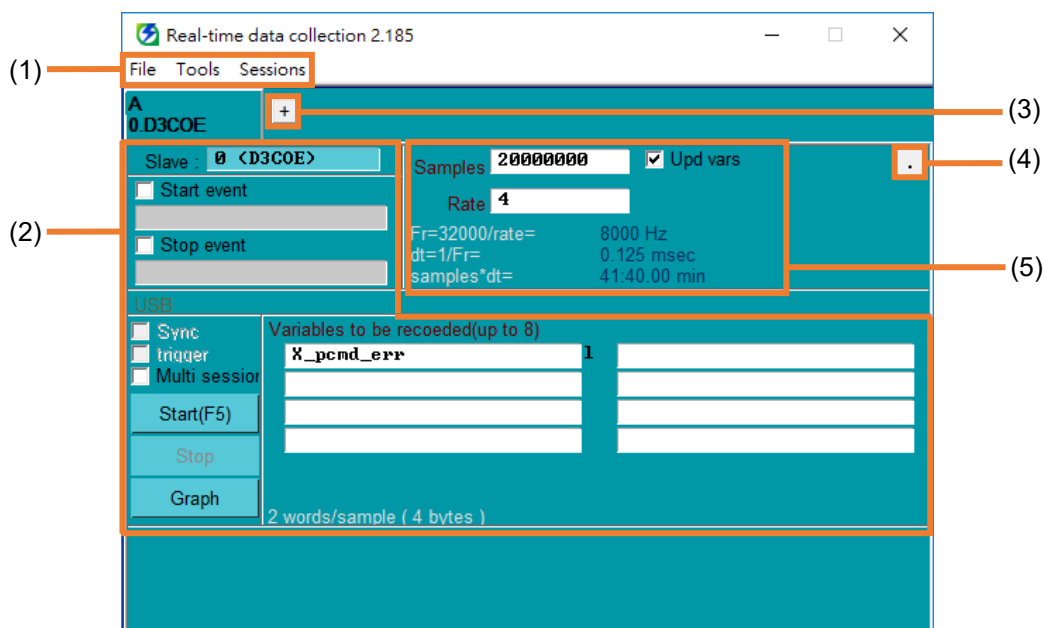



Figure 7.6.1.1

Table 7.6.1.1

No.	Item	Description		Reference
(1)	Toolbar	File	Save record settings: Save window settings as a file (*.rcw).	section 7.6.1.1
			Load record settings: Load settings file (*.rcw).	section 7.6.1.2
			Clear variables list: Clear Variables to be recorded column.	--
		Tools	Graph plot view: Generate the collected waveform.	Display waveform
		Sessions	Add new tab and switch to another tab.	--
(2)	Operation and settings for collection	Users can perform the related operation and settings for collection.		section 7.6.1.3
(3)	Add new tab	Click the button to add new tab.		section 7.6.1.4
(4)	Set the window to the top	Users can set “Real-time data collection” window to the top. If the button displays  , the window is on the top. If the button displays  , the window is not on the top.		--
(5)	Sampling settings	Users can do sampling settings based on actual situation.		section 7.6.1.5

7.6.1.1 Save record settings

Follow the procedure below to complete saving record settings.

1. Click **Save record settings** in **File**.

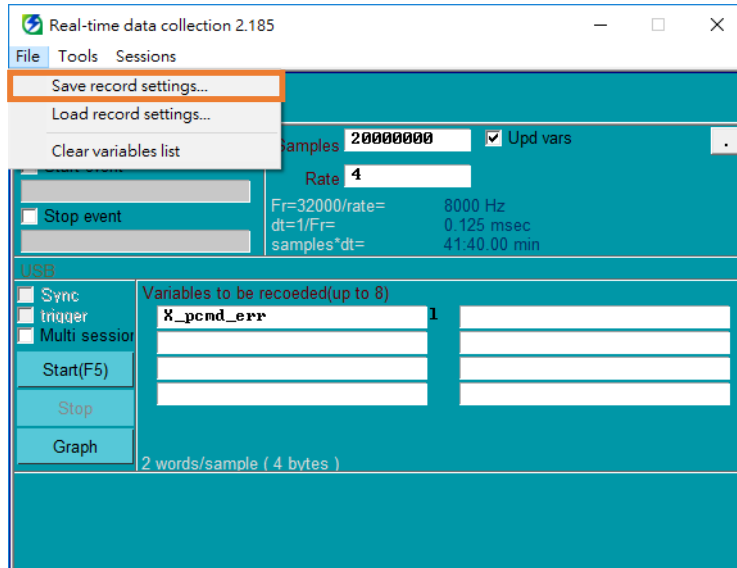

Figure 7.6.1.1.1

2. Key in file name of settings file (*.rcw), select archive path, and click **Save**.

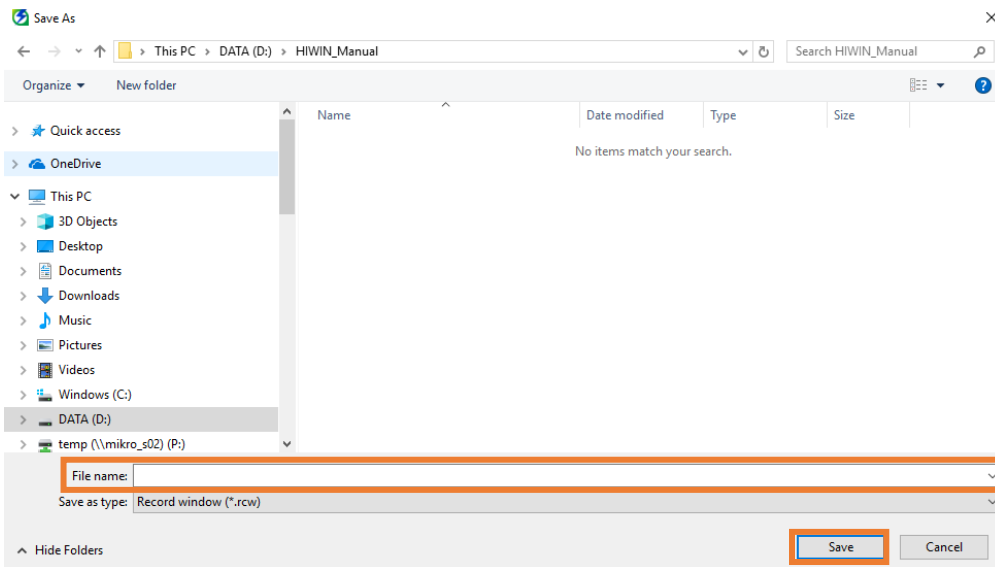

Figure 7.6.1.1.2

7.6.1.2 Load record settings

Follow the procedure below to complete loading record settings.

1. Click **Load record settings** in **File**.

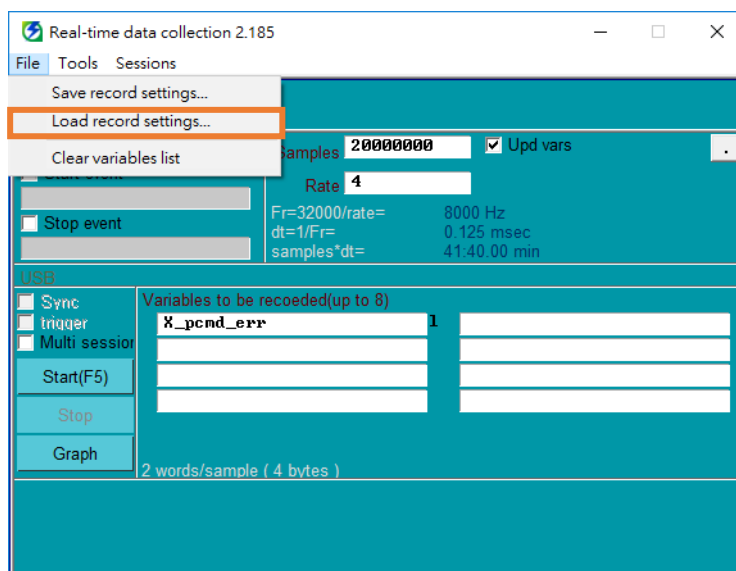

Figure 7.6.1.2.1

2. Select settings file (*.rcw), and click **Open**.

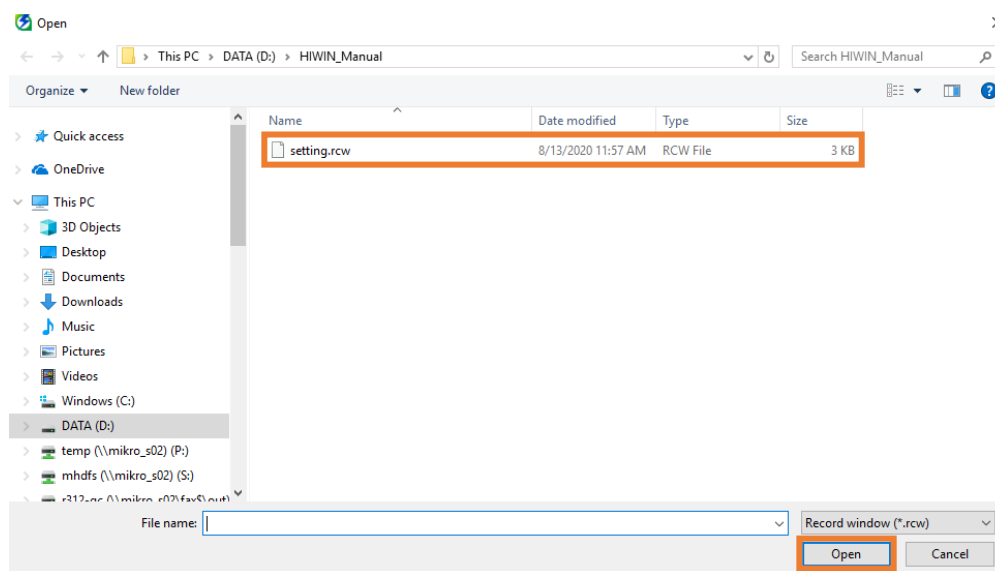

Figure 7.6.1.2.2

7.6.1.3 Operation and settings for collection

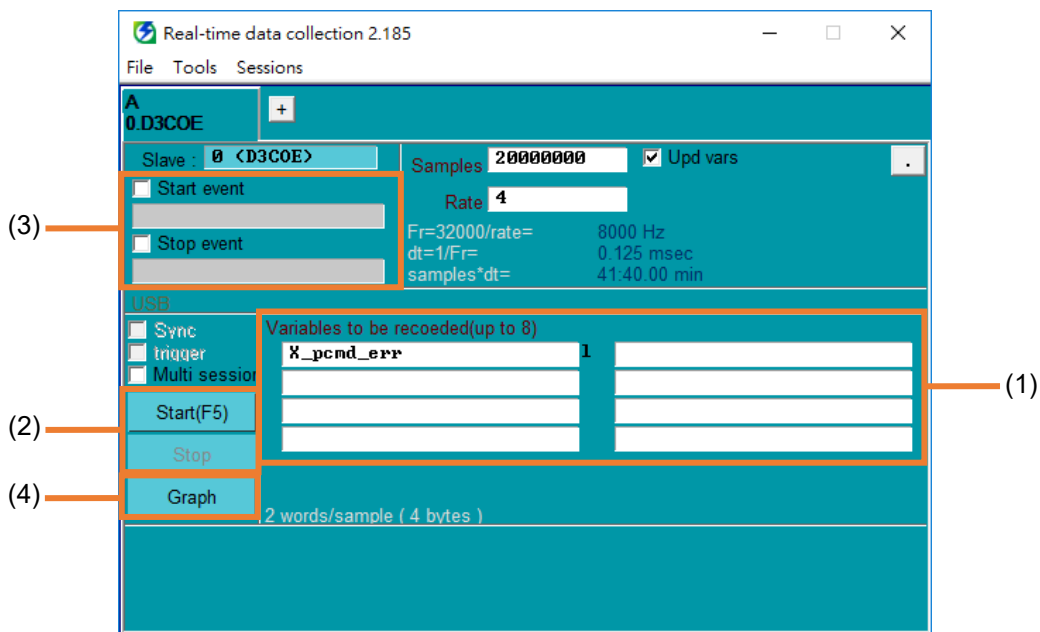

Figure 7.6.1.3.1

Table 7.6.1.3.1

No.	Item	Description	Reference
(1)	Collect variables	Users can key in the desired variables or Scope brings in the current monitoring items.	Collect variables
(2)	Start and stop collection	Click the button to start or stop collecting waveform.	Start and stop collection
(3)	Start event and stop event for collection	Users can set start event and stop event for collection.	Start event and stop event for collection
(4)	Display waveform	Click the button to display the collected waveform.	Display waveform

■ Collect variables

Users can key in the desired variables or Scope brings in the current monitoring items.

◆ Method 1: Users key in the desired variables.

1. Click the column to key in the variable.

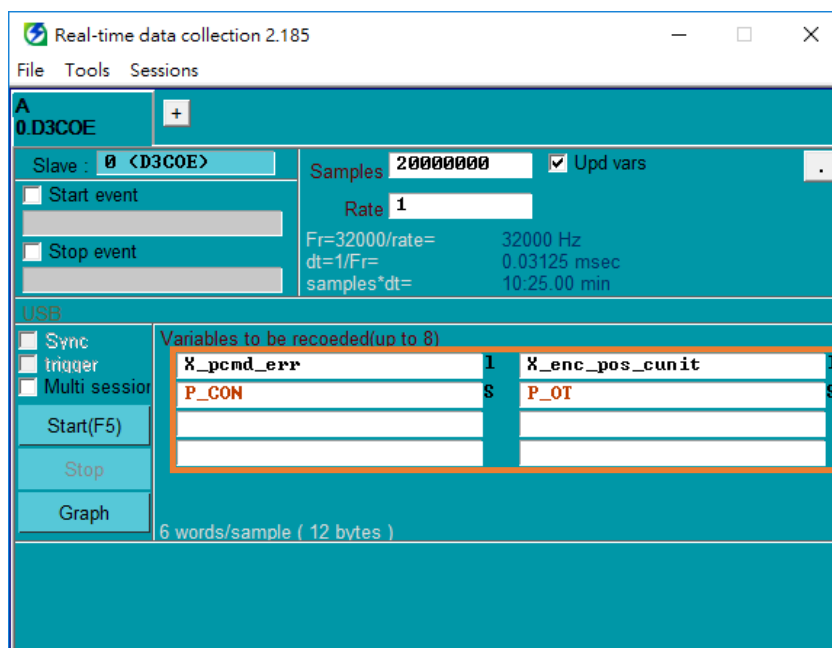

Figure 7.6.1.3.2

2. After users key in the variable, the background of the column will display yellow. At this time, it is not effective. To make it be effective, press Enter key on the keyboard.

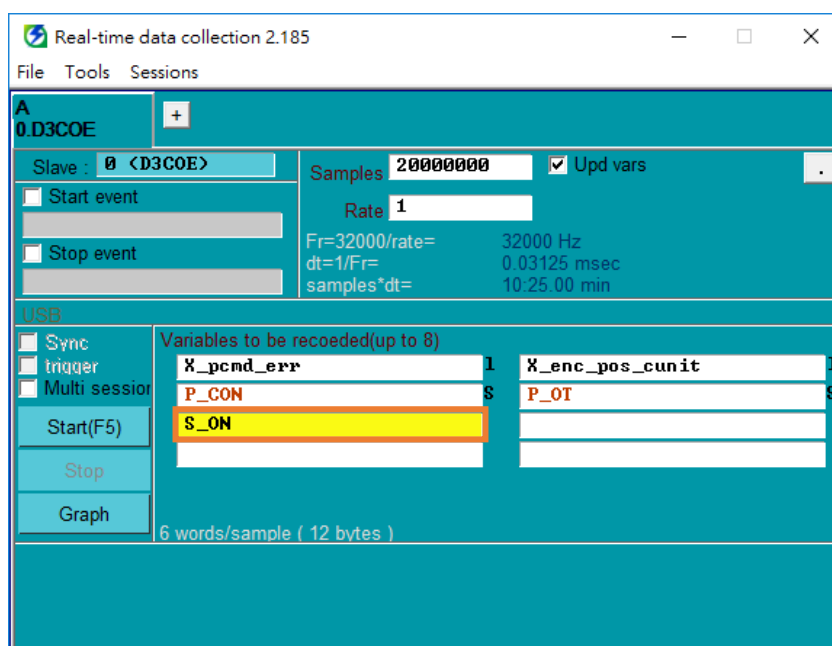

Figure 7.6.1.3.3

◆ Method 2: Scope brings in the current monitoring items.

1. Click **D** to open “Real-time data collection” window.

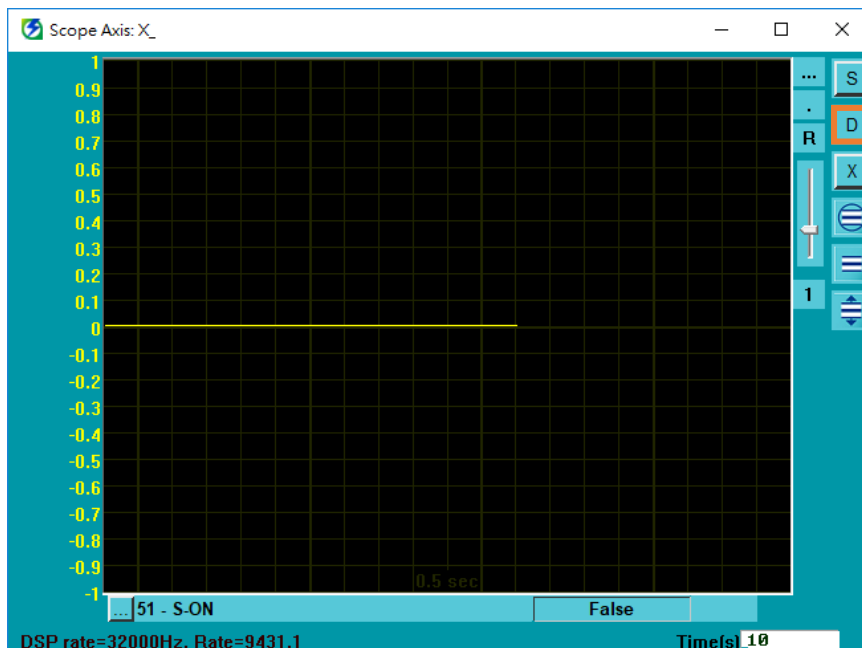

Figure 7.6.1.3.4

2. Thunder will send the current item observed by Scope (51-servo on input signal) to the column (S_ON).

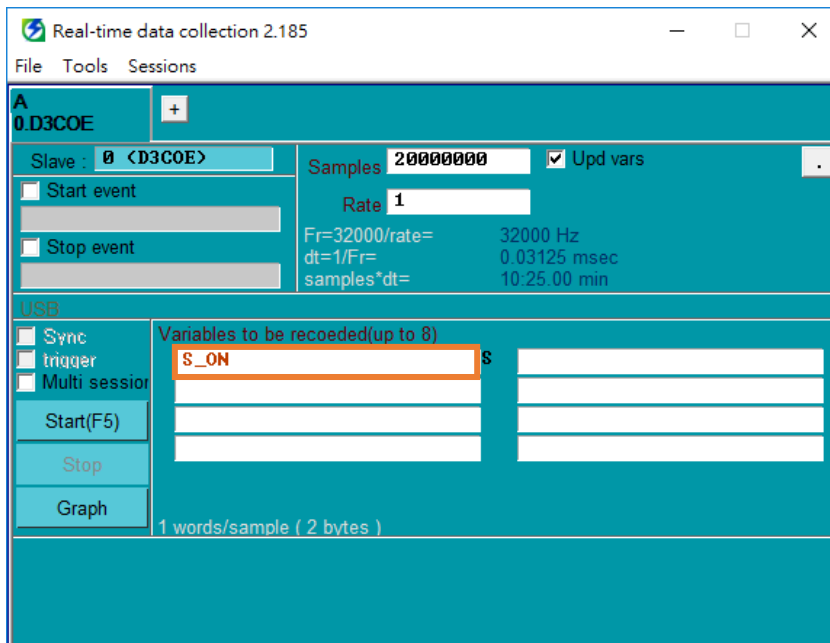

Figure 7.6.1.3.5

■ Start and stop collection

1. Click **Start(F5)**.

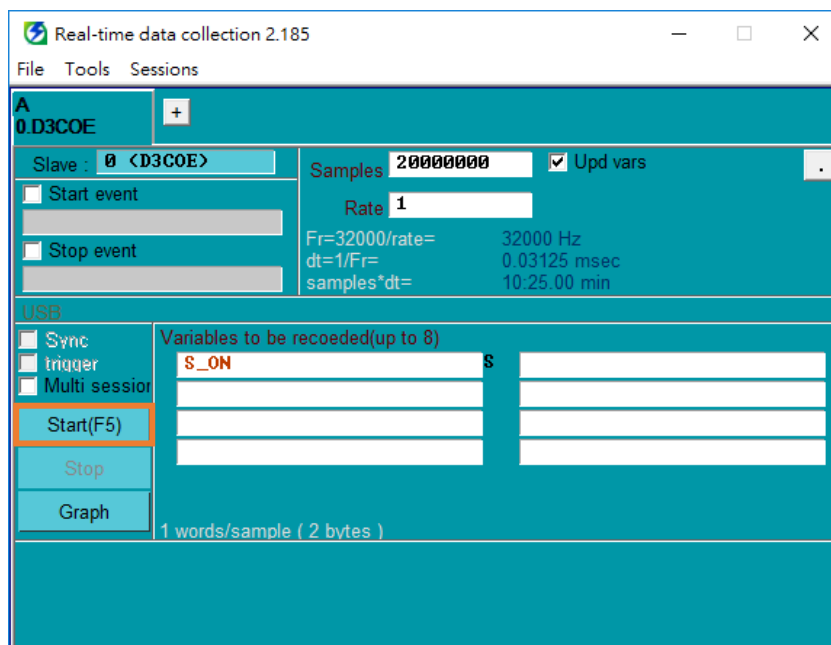

Figure 7.6.1.3.6

2. Start collecting waveform.

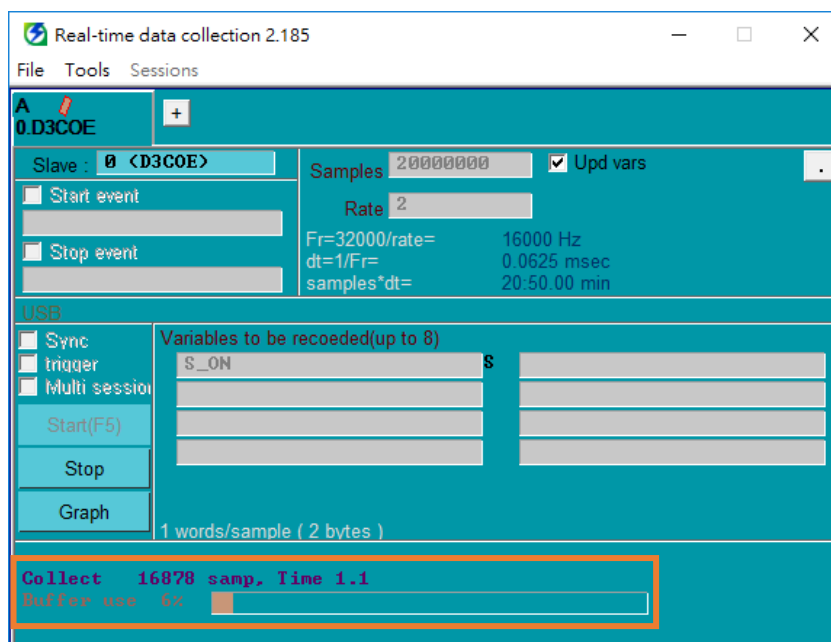

Figure 7.6.1.3.7

- To stop collecting waveform, click **Stop** or wait until the collection time ends. At this time, **Data Collection ended successfully** will appear at the bottom of the window.

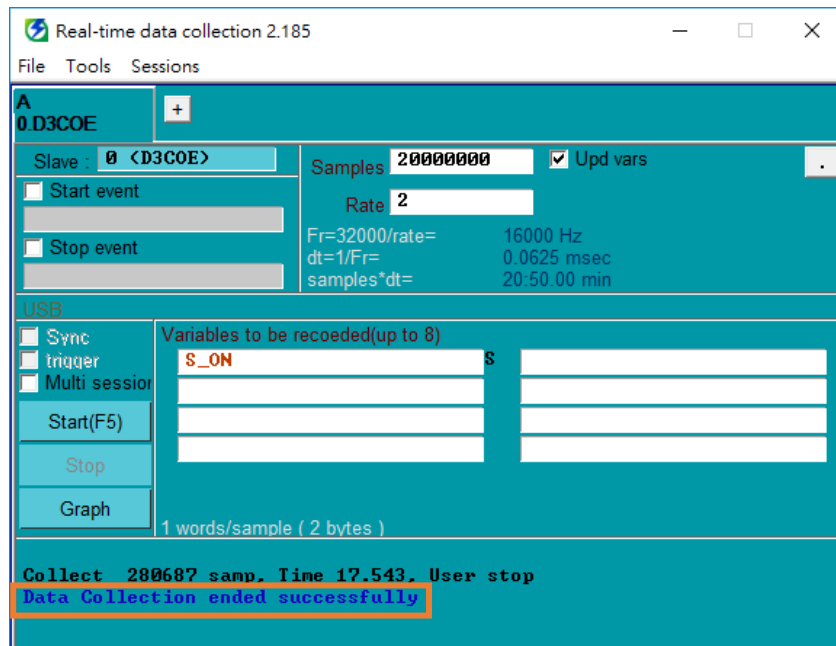

Figure 7.6.1.3.8

■ Start event and stop event for collection

Users can trigger or modify the event to record waveform.



Start event is **trigger S_ON** and stop event is **release S_ON**.

Example

1. Check **Start event** and **Stop event**, and key in the event-related variable.

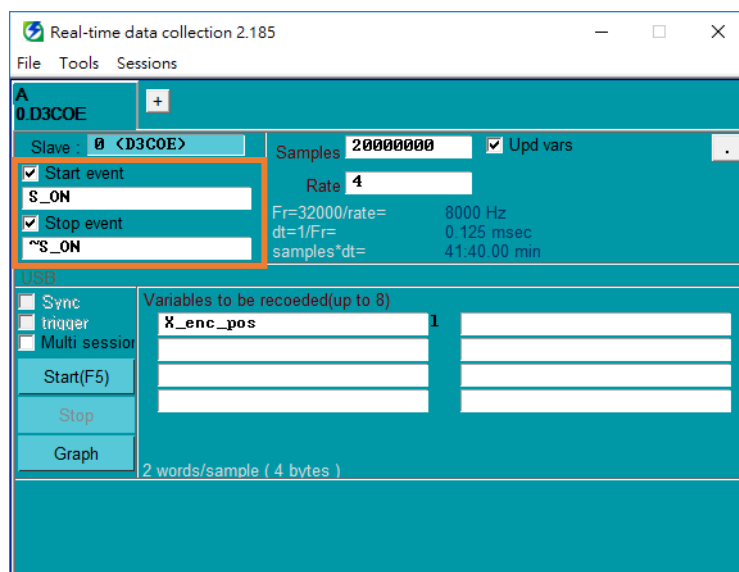

Figure 7.6.1.3.9

2. After users click **Start(F5)**, **Waiting to event** will appear. The waveform will not be collected until start event is triggered.

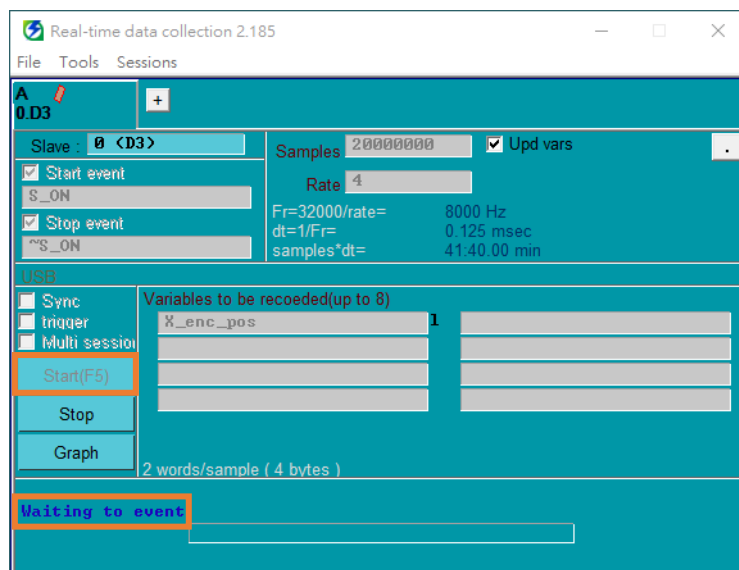

Figure 7.6.1.3.10

- S_ON is triggered, which satisfies start event for collection. Start collecting waveform.

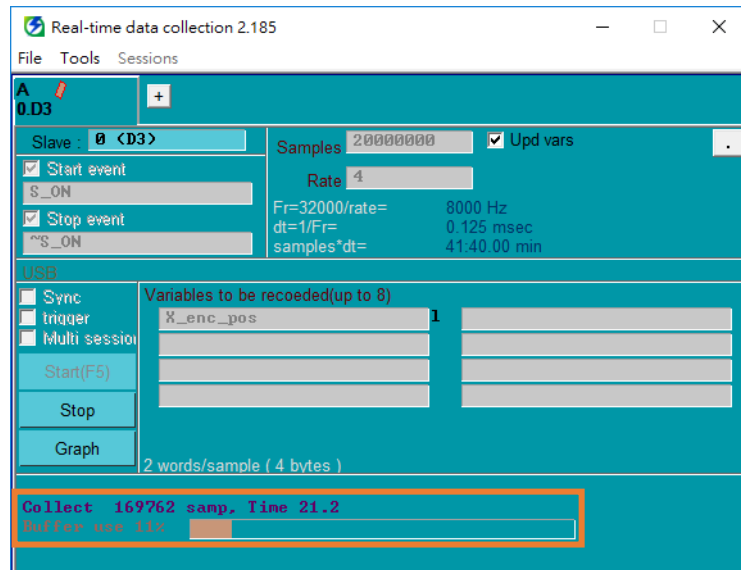

Figure 7.6.1.3.11

- S_ON is released, which satisfies stop event for collection. Stop collecting waveform.

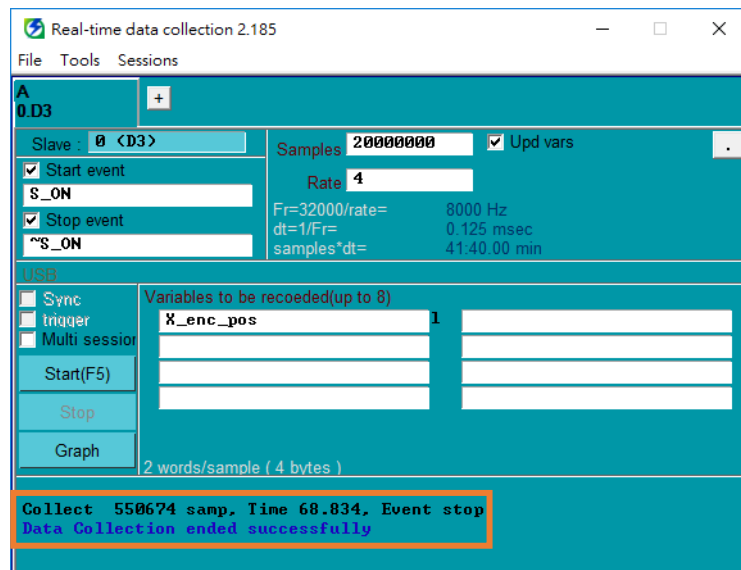

Figure 7.6.1.3.12

■ Display waveform

1. After the waveform is collected, click **Graph** or **Graph plot view** in **Tools**.

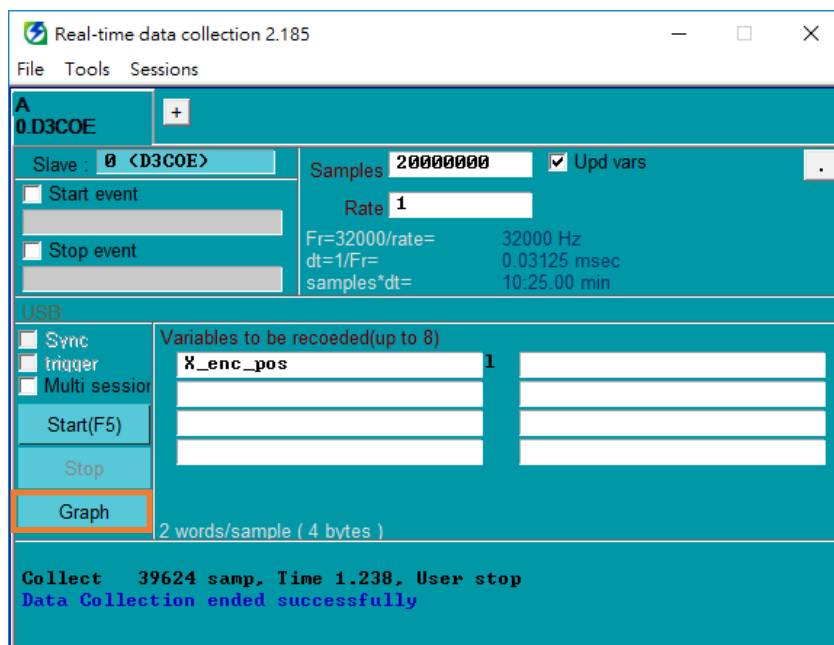

Figure 7.6.1.3.13

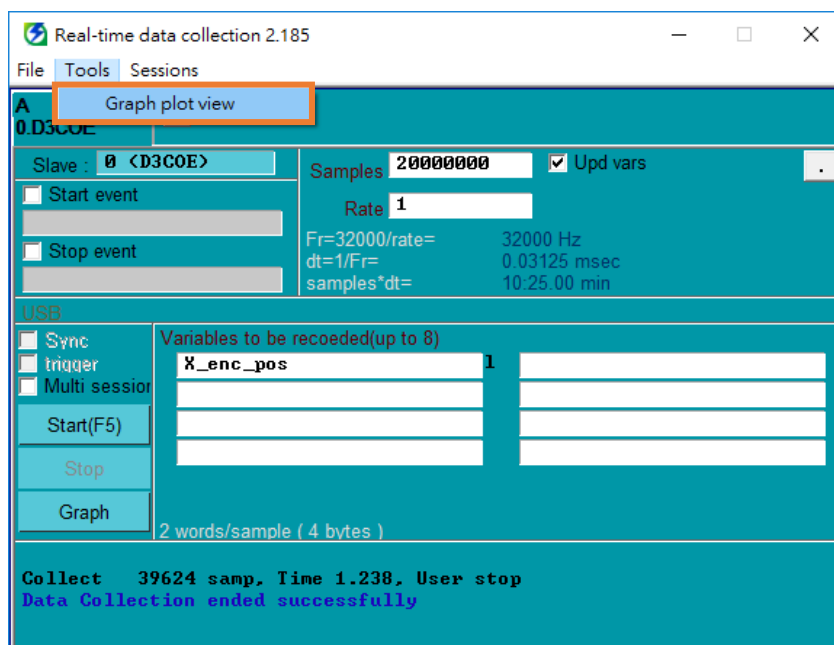

Figure 7.6.1.3.14

- Open “Plot view” window and display waveform. Refer to section 7.6.2 for the related information of “Plot view” window.

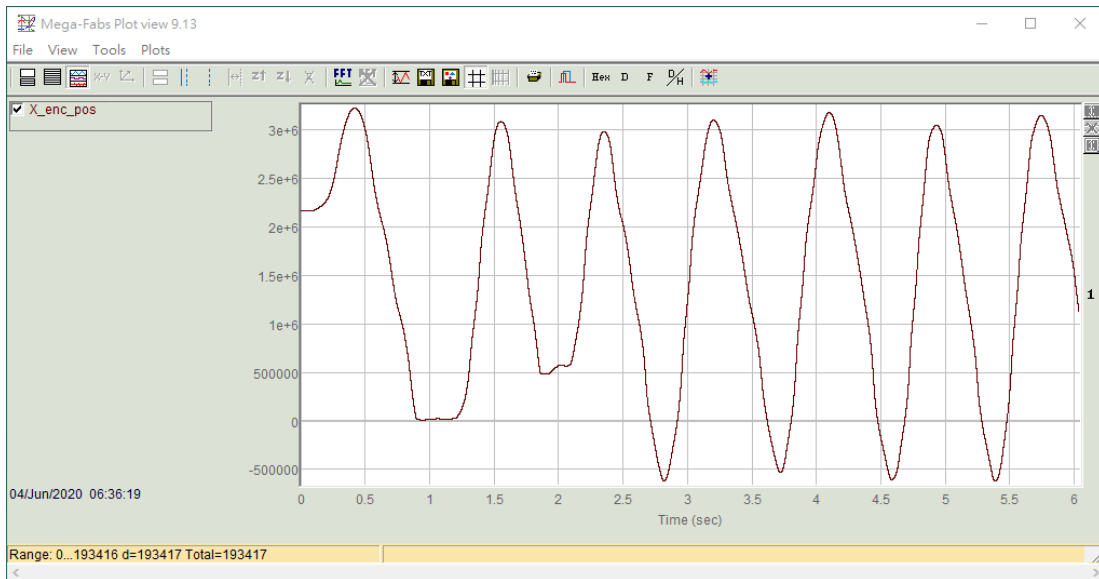

Figure 7.6.1.3.15

7.6.1.4 Add new tab

Follow the procedure below to add new tab.

- Click  to add new tab.

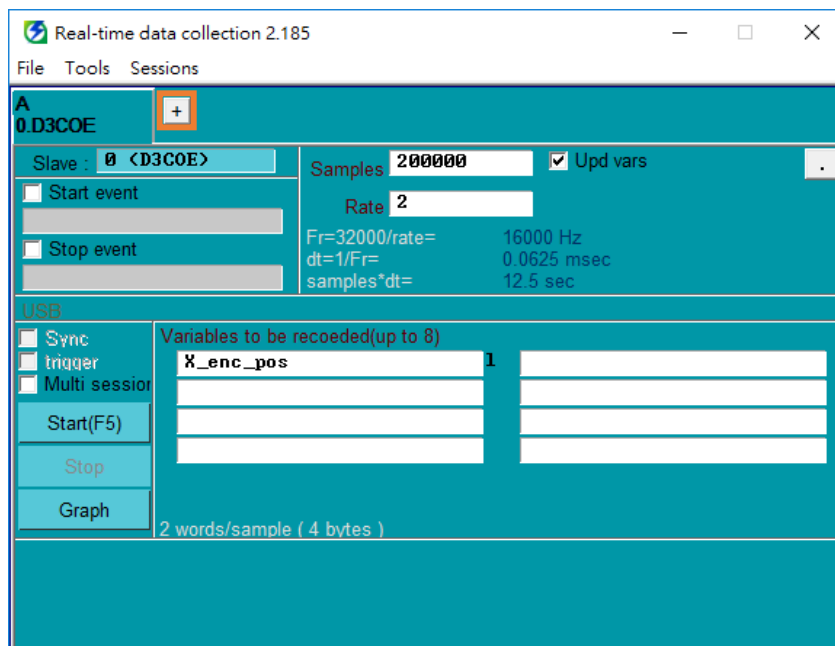

Figure 7.6.1.4.1

2. Complete adding new tab.

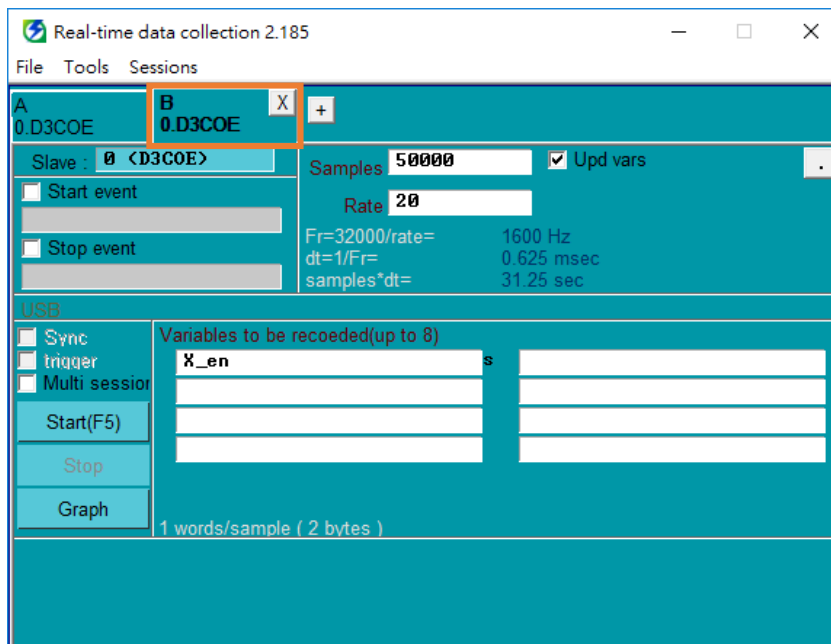

Figure 7.6.1.4.2

7.6.1.5 Sampling settings

Users can set sampling number and sampling rate based on requirement, and perform background updating.

■ Sampling number and sampling rate

Table 7.6.1.5.1

Item	Description
Sampling number	Sampling number of each variable.
Sampling rate	Sample a data every number of interrupts decided by users.

1. Set sampling number and sampling rate to decide collection frequency, collection cycle and collection time.



Example

If users set sampling number as 200000 and sampling rate as 2, the following results will be automatically calculated by Thunder: collection frequency is 16000 Hz, collection cycle is 0.0625 msec and collection time is 12.5 sec.

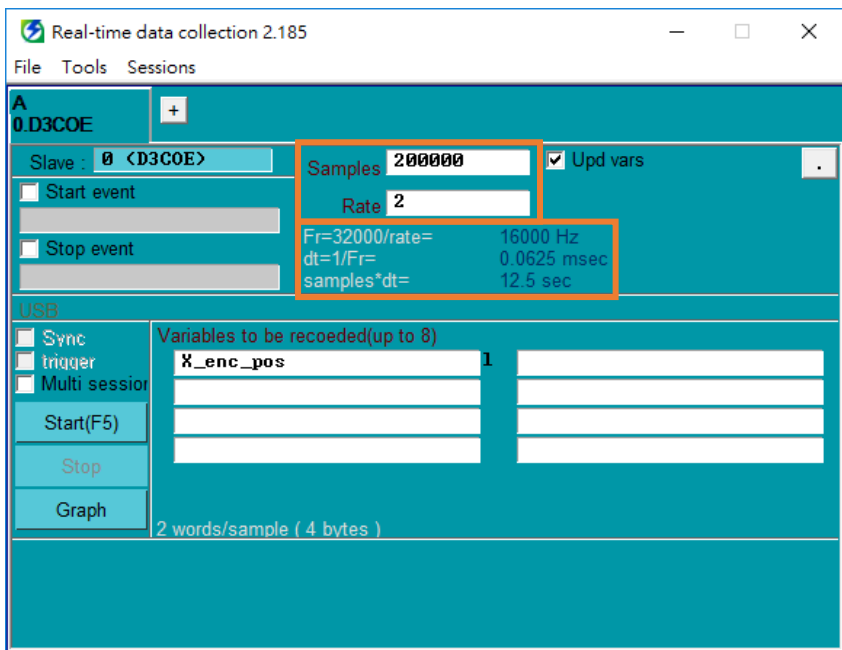

Figure 7.6.1.5.1

2. Click **Start(F5)** to collect waveform. After 12.5 seconds, 200000 samples are collected and waveform collection is done.

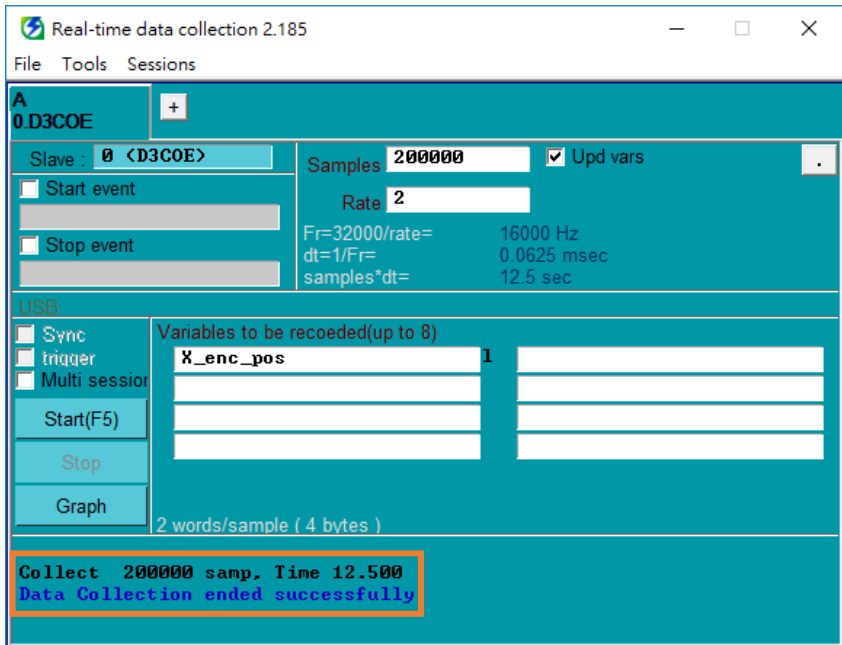

Figure 7.6.1.5.2

■ Background updating

If users check **Upd vars**, the values or waveform outside “Real-time data collection” window will still be updated in real-time during data collection.

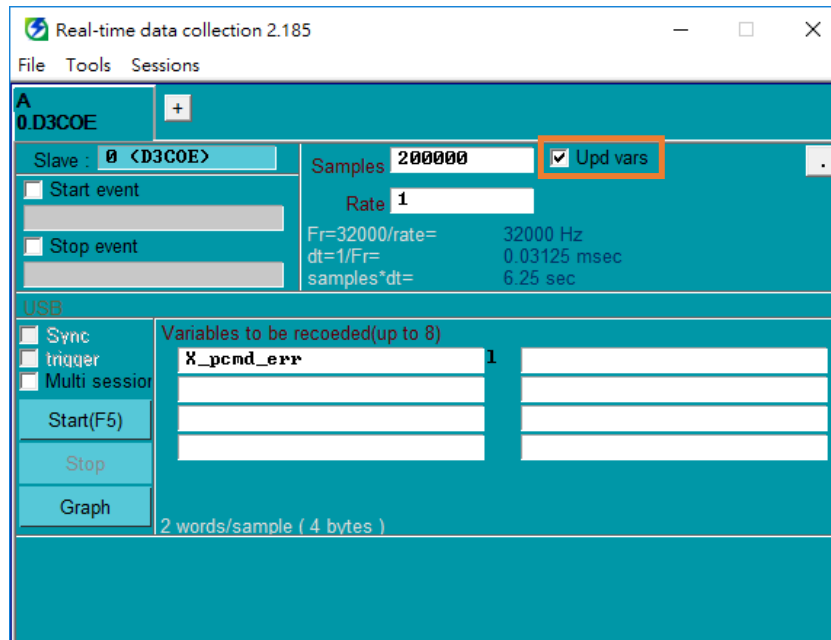

Figure 7.6.1.5.3

7.6.2 Plot view

“Plot view” window displays the waveform generated by real-time data collection. Refer to **Display waveform** to open “Plot view” window.

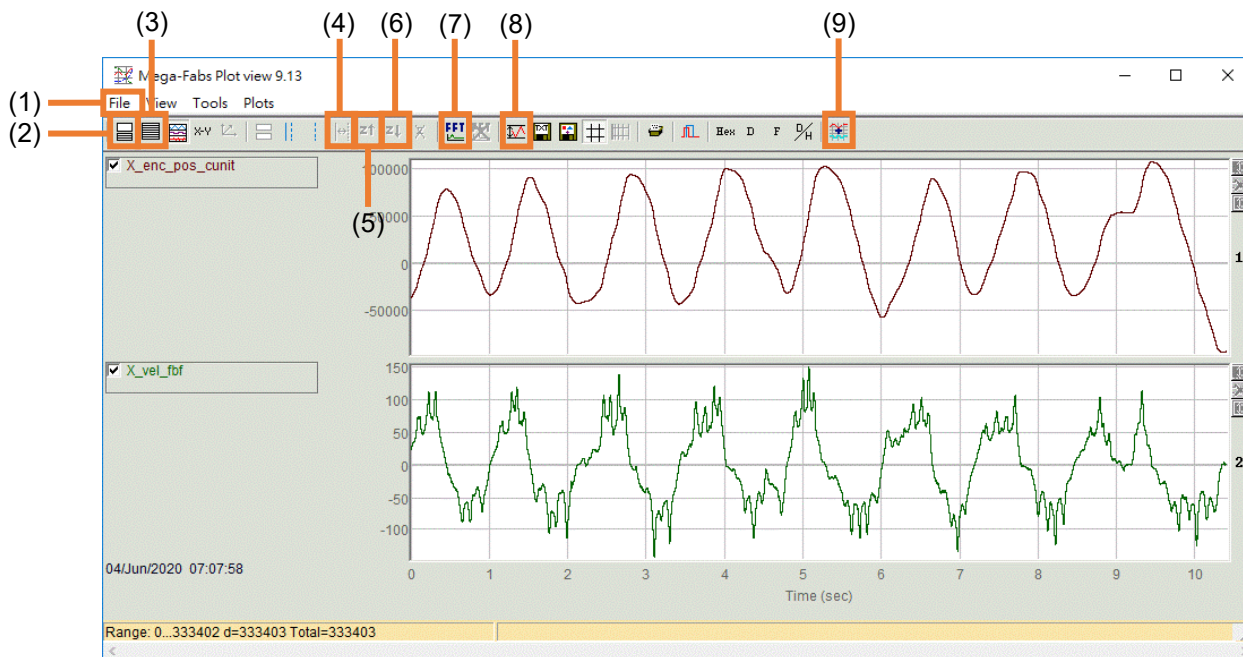

Figure 7.6.2.1

Table 7.6.2.1

No.	Item	Description	Reference	
(1)	File	Open	Users can load waveform file (*.gpp) to “Plot view” window.	section 7.6.2.1
		Save	Users can save waveform as waveform file (*.gpp).	section 7.6.2.2
(2)	Set show mode	Users can set the waveforms to be displayed in “Plot view” window.	section 7.6.2.3	
(3)	Set maximum number of graph views	Users can set the channels to be displayed in “Plot view” window.	section 7.6.2.4	
(4)	Zoom the area between cursors	Users can zoom in the area between cursors.	section 7.6.2.5	
(5)	Undo zoom	Cancel zoom in the area between cursors.	section 7.6.2.6	
(6)	Redo zoom	Zoom in the area between cursors again.	section 7.6.2.7	
(7)	FFT	Users can perform FFT calculation on waveform.	--	
(8)	Statistics table	It is the column which displays the status of waveform.	section 7.6.2.8	
(9)	Math operation	Users can perform math operation on waveform.	--	

7.6.2.1 Open

1. Click **Open** in **File**.

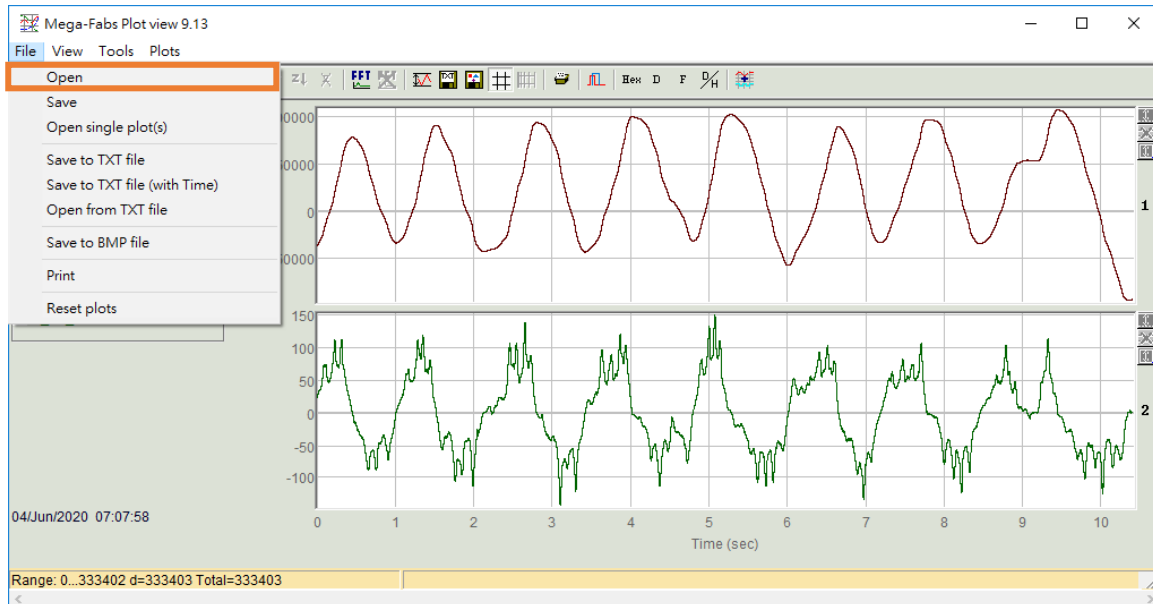

Figure 7.6.2.1.1

2. Select waveform file (*.gpp), and click **Open**.

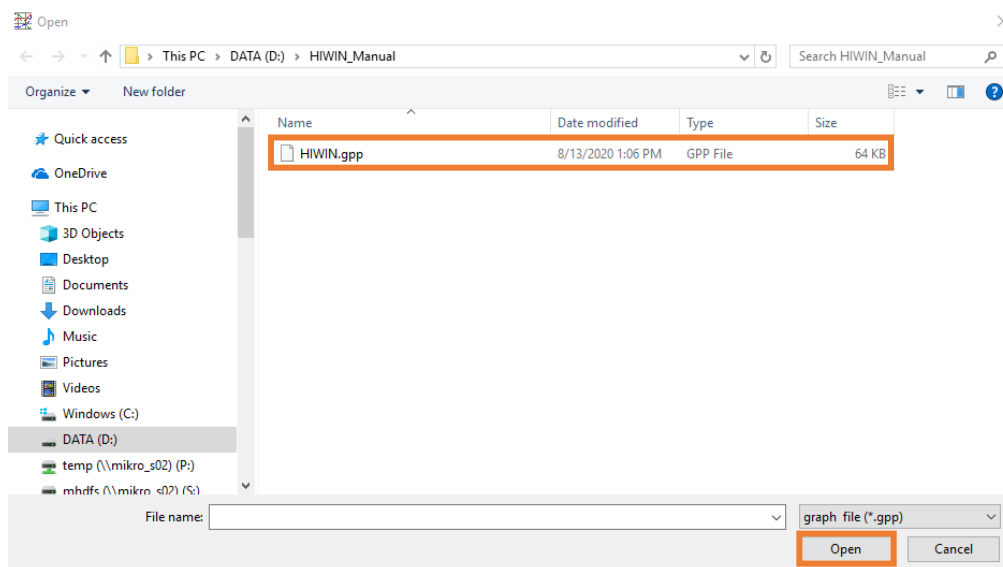

Figure 7.6.2.1.2

7.6.2.2 Save

1. Click **Save** in **File**.

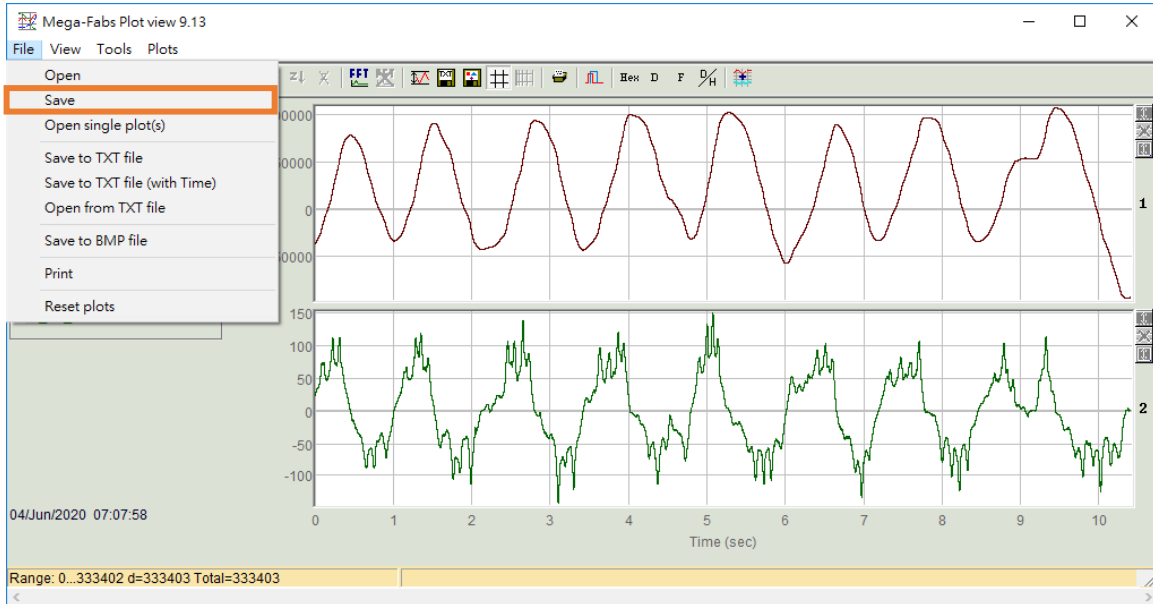

Figure 7.6.2.2.1

2. Key in file name of waveform file (*.gpp), select archive path, and click **Save**.

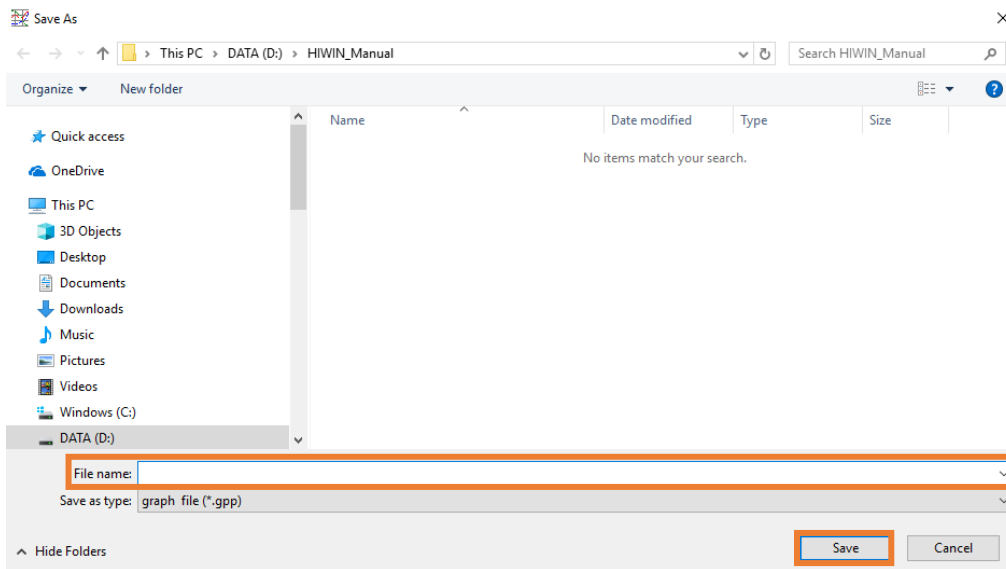

Figure 7.6.2.2.2

7.6.2.3 Set show mode

1. Click “Set show mode” icon.

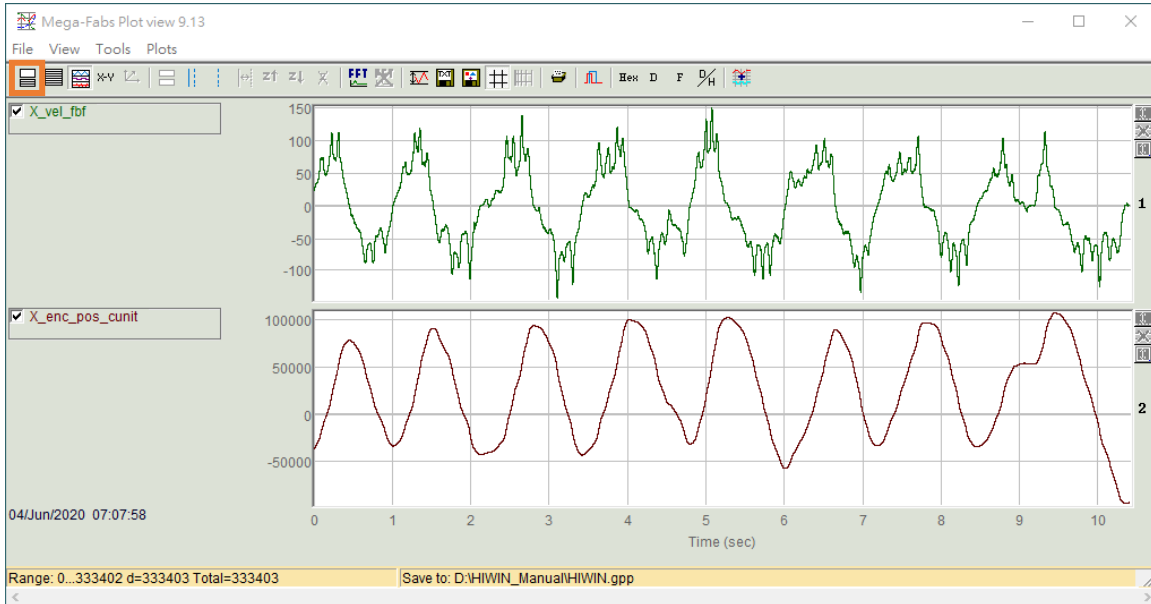

Figure 7.6.2.3.1

2. Select **All graphs** to observe all recorded waveforms.

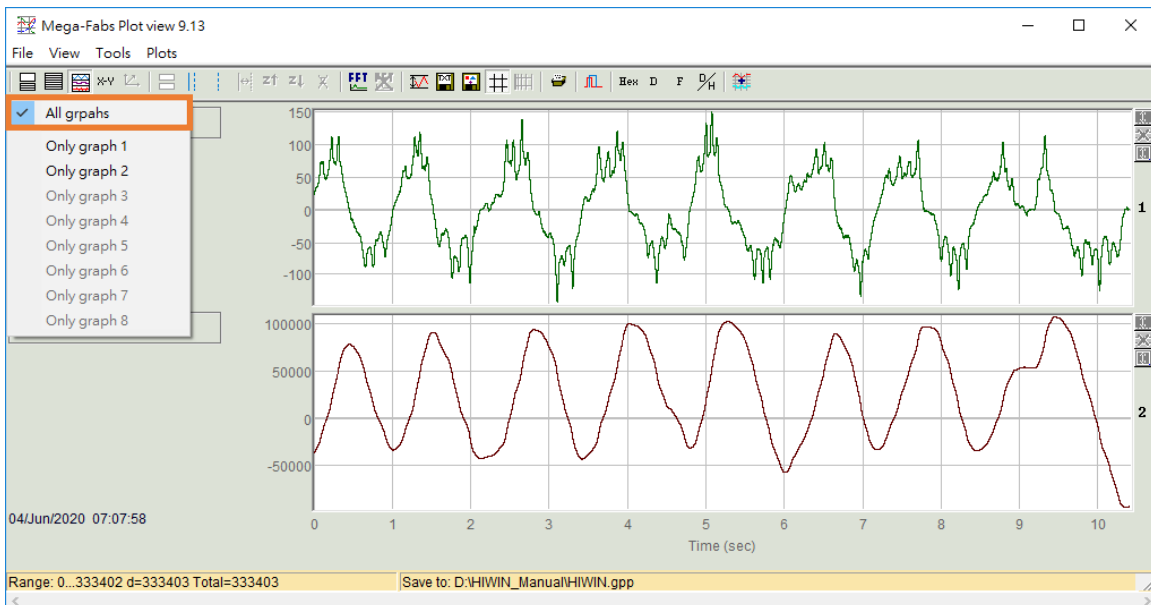

Figure 7.6.2.3.2

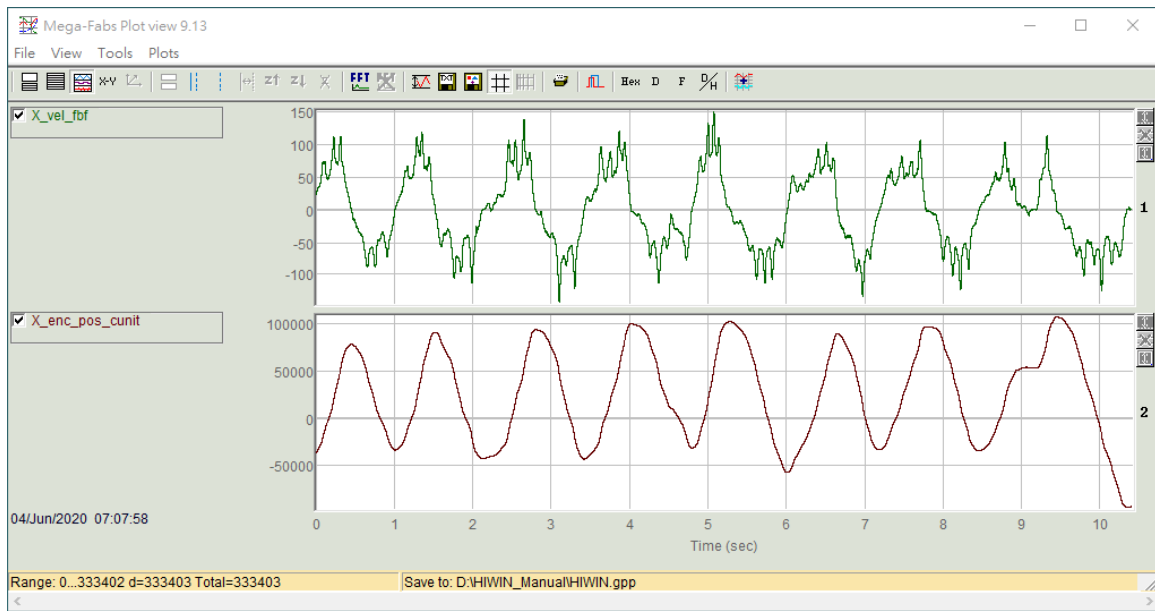

Figure 7.6.2.3.3

3. Select **Only graph** to observe the desired waveform.

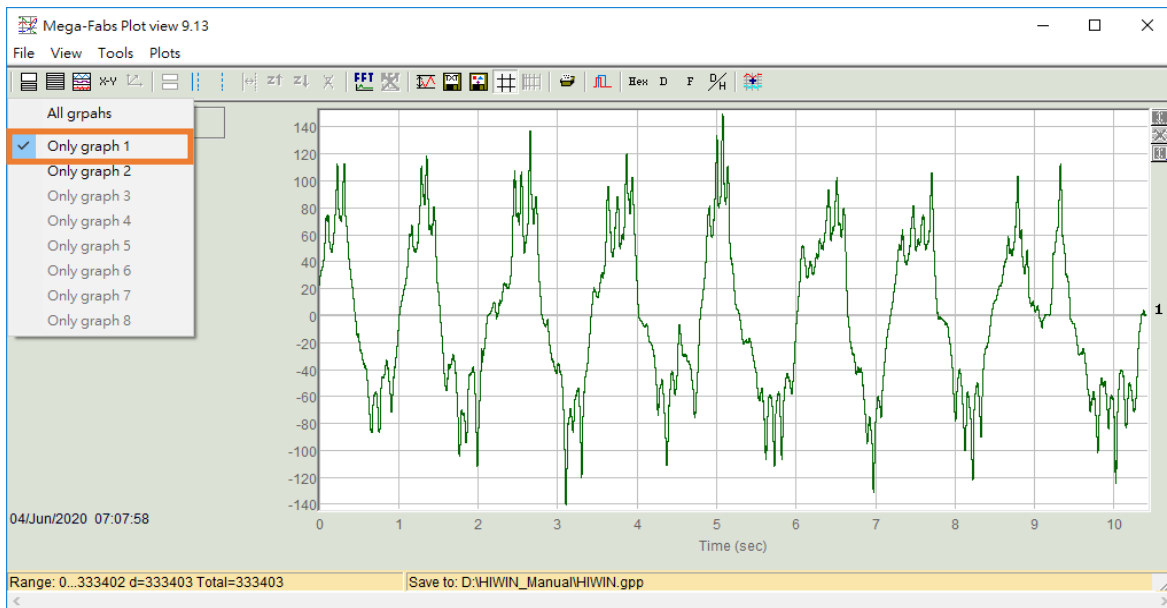

Figure 7.6.2.3.4

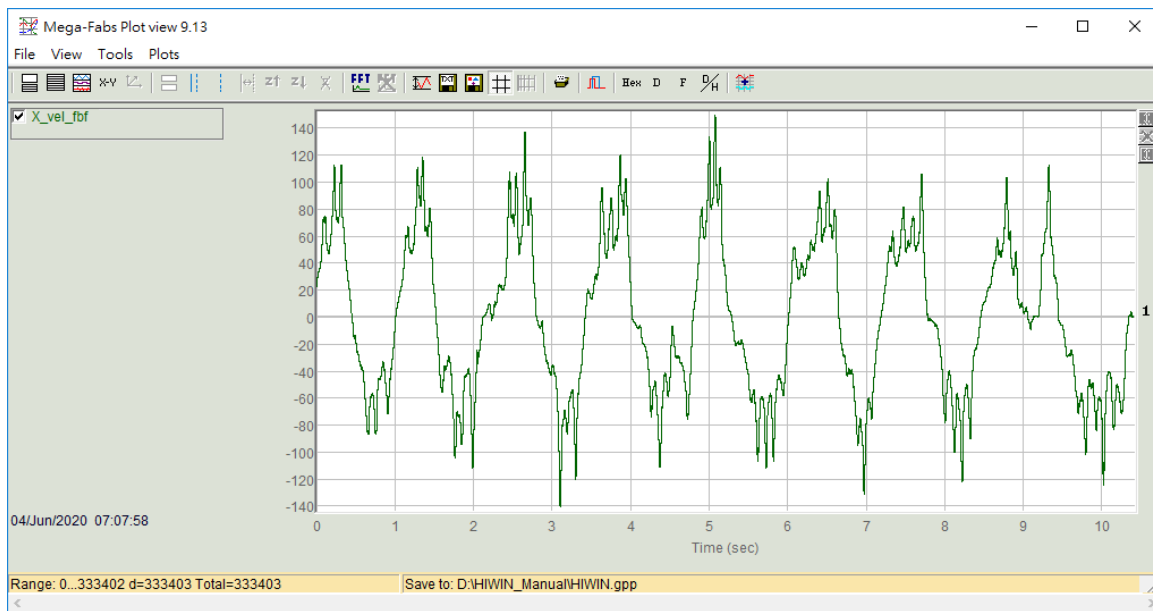

Figure 7.6.2.3.5

7.6.2.4 Set maximum number of graph views

1. After clicking “Set maximum number of graph views” icon, users can select the maximum number of displayed waveforms.

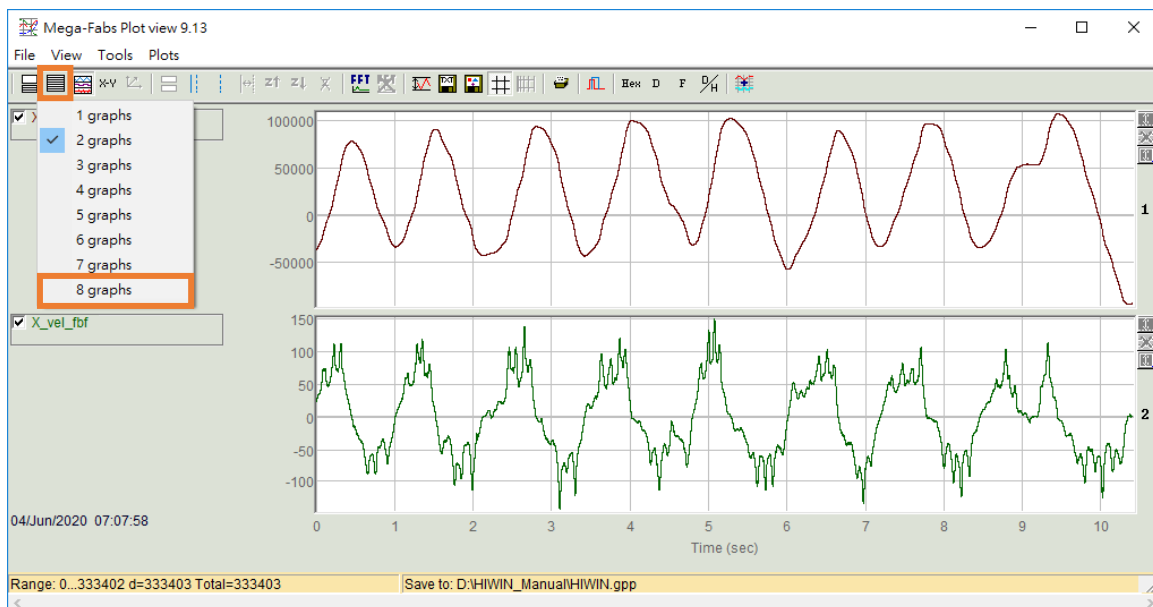

Figure 7.6.2.4.1

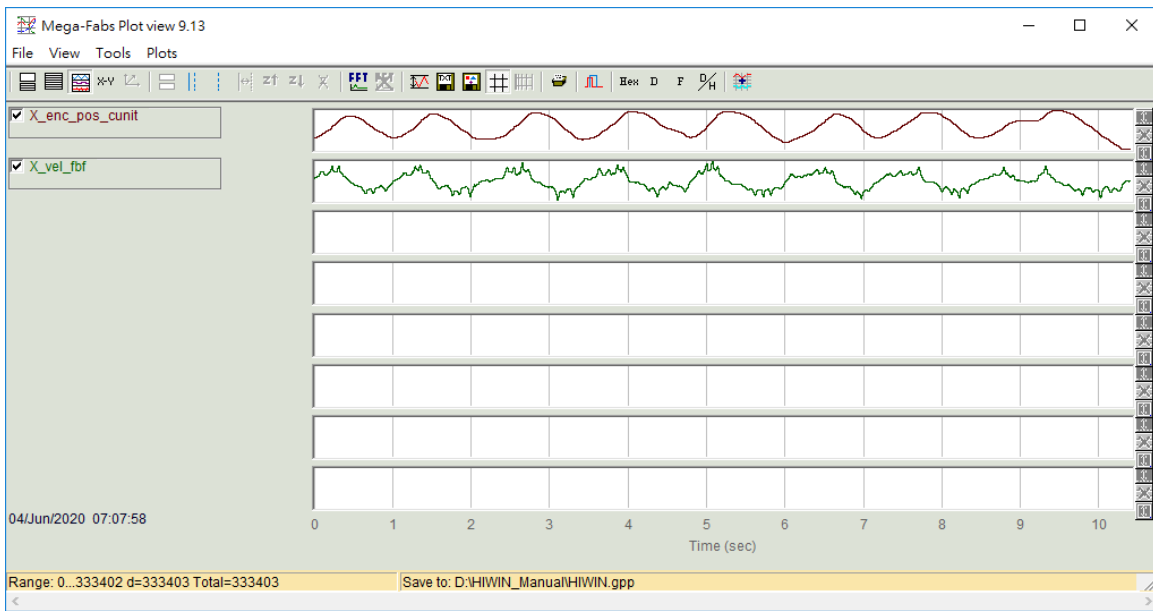

Figure 7.6.2.4.2

2. To put the variable to another channel, hold the variable box and drag it.

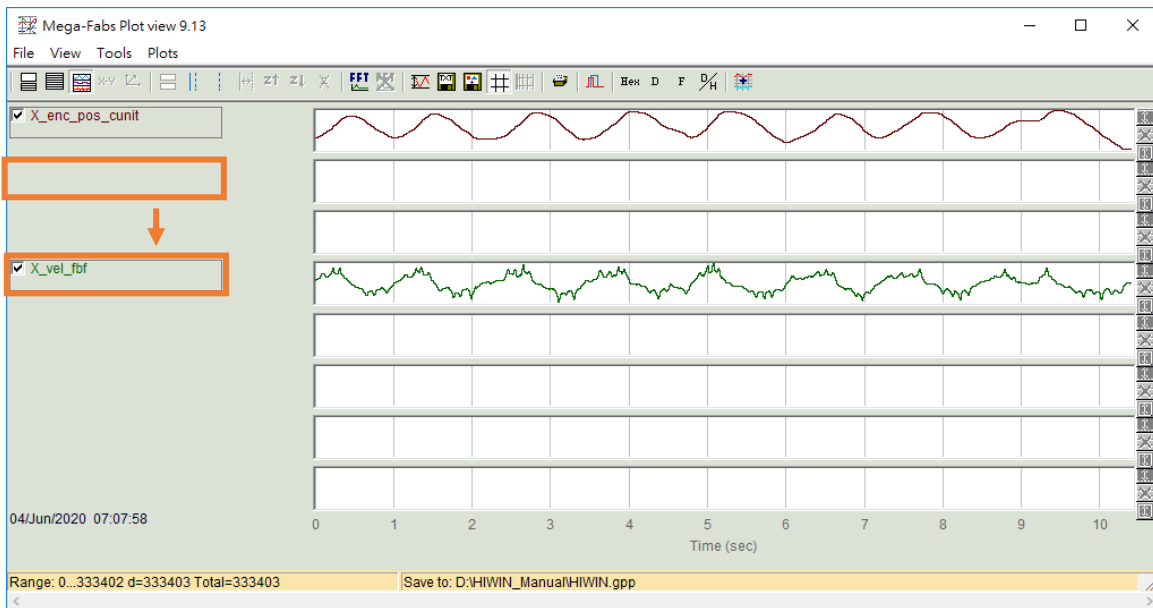

Figure 7.6.2.4.3



Information

- (1) If the maximum number of displayed waveforms is less than the actual number of waveforms, the window will display the top waveforms.
- (2) To observe two waveforms at the same channel, check the box in front of the variable.

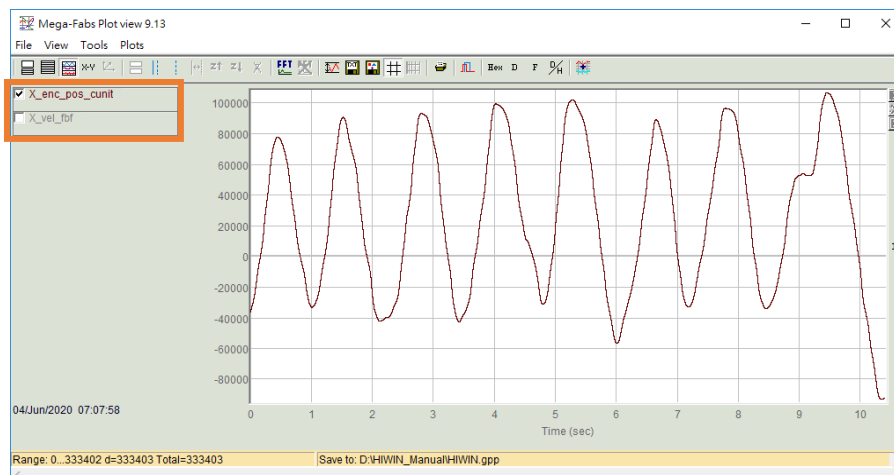

Figure 7.6.2.4.4

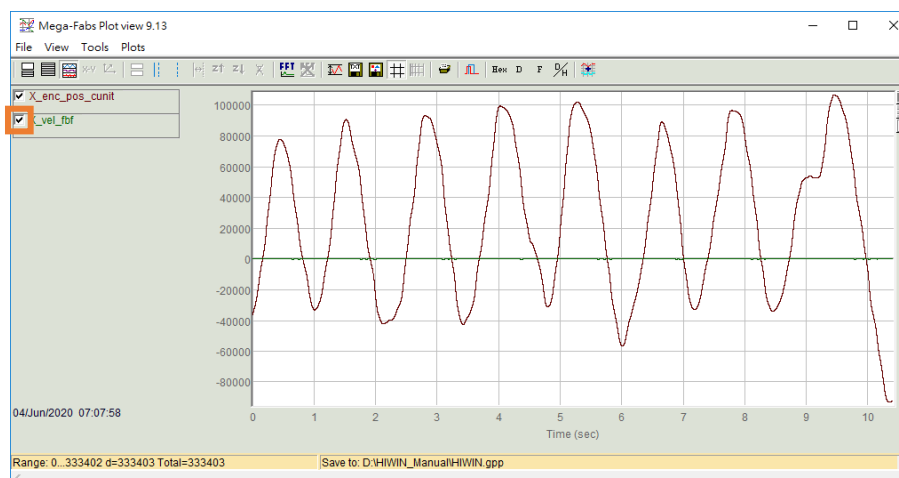

Figure 7.6.2.4.5

7.6.2.5 Zoom the area between cursors

1. To observe the waveform of a certain area, get blue solid line (left-click) and get blue dashed line (right-click) to frame the area to be observed.



Figure 7.6.2.5.1

2. Click "Zoom the area between cursors" icon to zoom in the framed waveform.

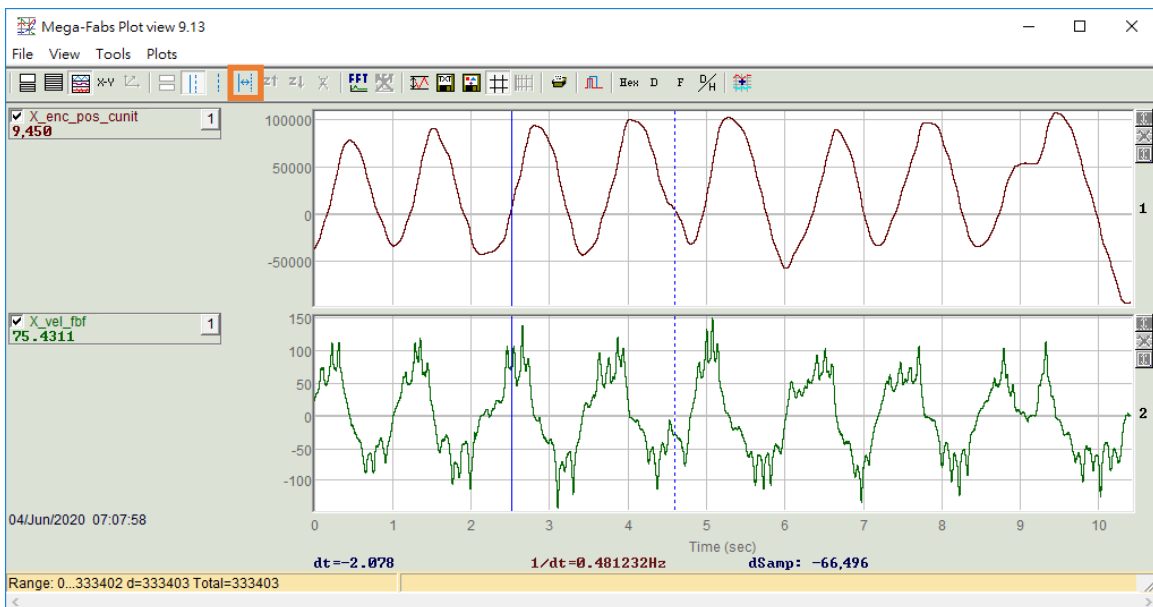

Figure 7.6.2.5.2



Figure 7.6.2.5.3

7.6.2.6 Undo zoom

Click “Undo zoom” icon to cancel zoom in the waveform.



Figure 7.6.2.6.1

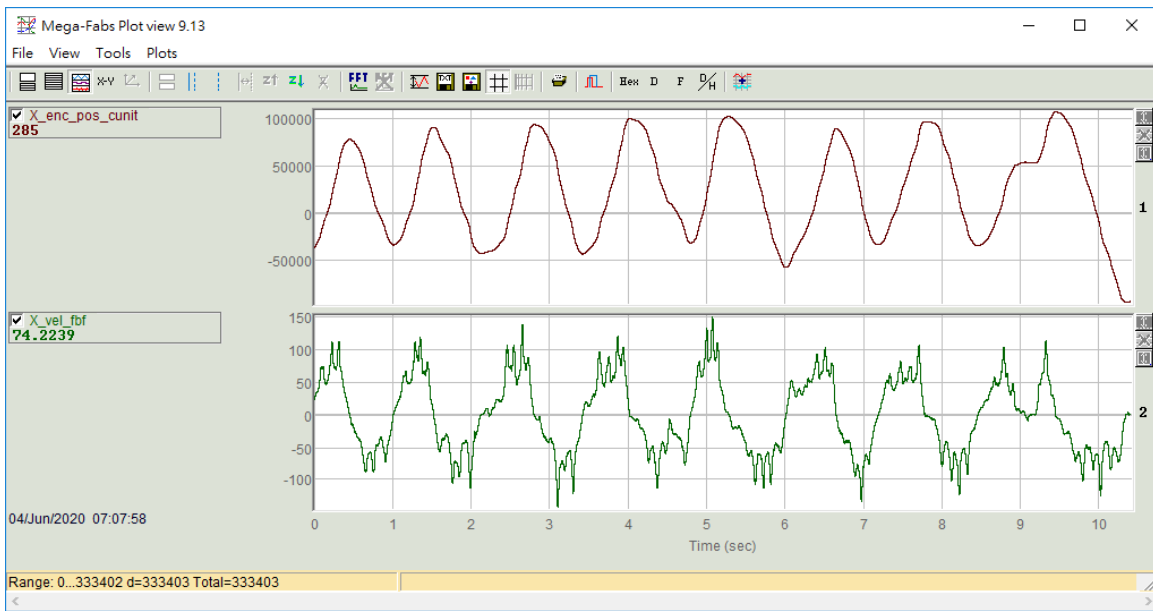

Figure 7.6.2.6.2

7.6.2.7 Redo zoom

If “Undo zoom” function has been used, users can click “Redo zoom” icon to zoom in the waveform again.

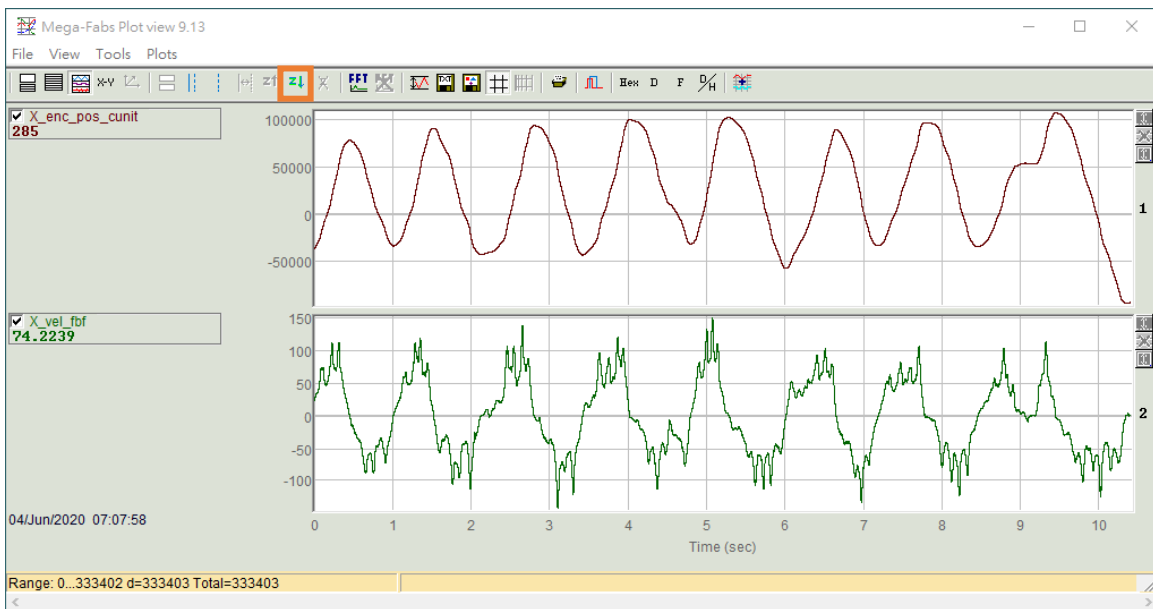

Figure 7.6.2.7.1

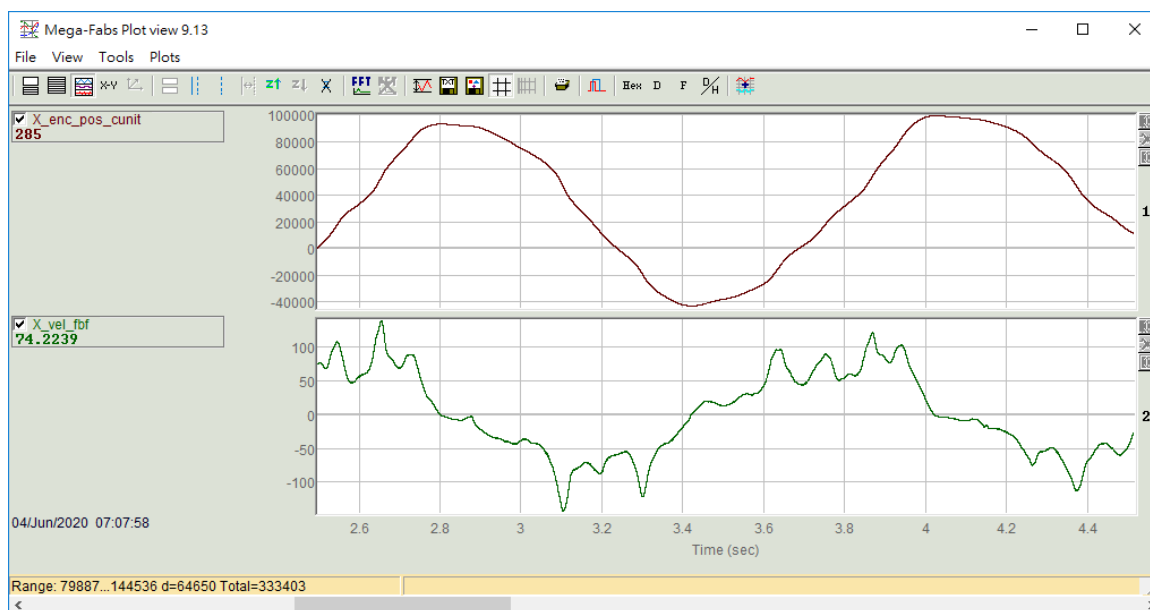

Figure 7.6.2.7.2

7.6.2.8 Statistics table

Click “Statistics table” icon to observe the related information of waveform.

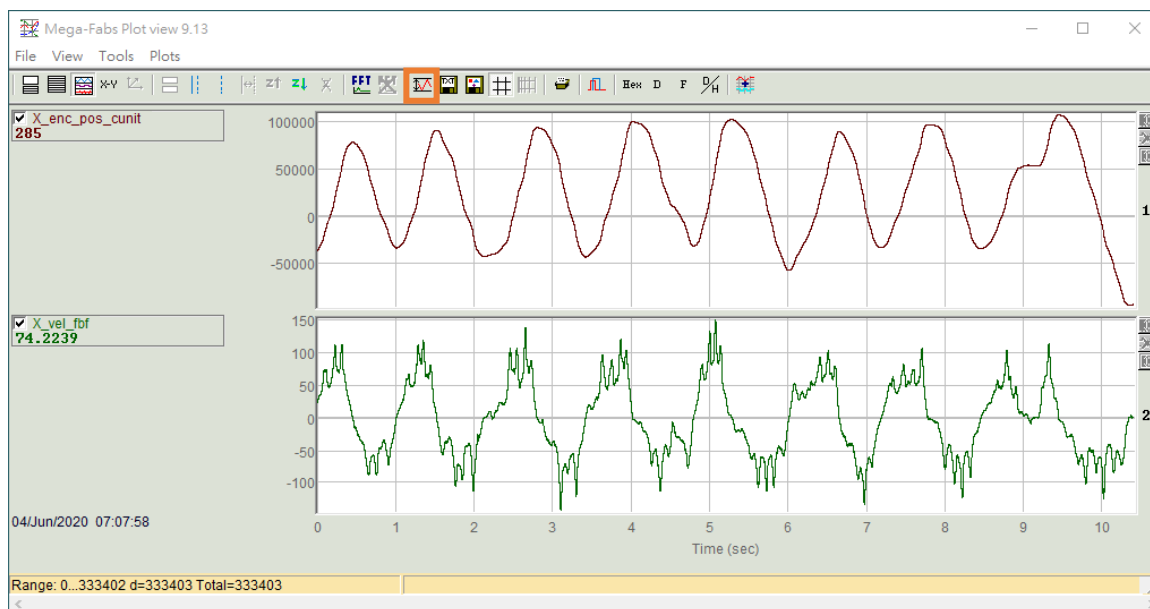

Figure 7.6.2.8.1

Plot statistics		
	X_enc_pos_cunit	X_vel_fbf
Type:	Long(32 bit)	Float(32 bit)
Maximum:	106,557	149.664
Maximum at sample:	302,362	162,476
Minimum:	-92,854	-140.354
Minimum at sample:	330,986	99,348
Average:	25310.1	-1.24263
p2p = max-min:	199,411	290.018
ripA=p2p/Average:	787.872%	-23339%
rms (sigma):	49524.9	56.473
Ripple=rms/Average:	195.673%	-4544.63%
Range: 0...333402, delta=333403, total 333403 Ts=3.125e-5		

Figure 7.6.2.8.2

8. Troubleshooting

8.	Troubleshooting.....	8-1
8.1	Brief introduction.....	8-2
8.2	Real-time monitoring.....	8-3
8.2.1	Brief introduction	8-3
8.2.2	Alarm monitoring.....	8-3
8.2.3	Warning monitoring.....	8-4
8.3	Error log.....	8-5

8.1 Brief introduction

When an alarm or a warning occurs, Thunder main window will respond in real-time. Besides, it records the past alarm messages, elaborates the possible causes, and provides manual troubleshooting methods in Error log.

Real-time monitoring

When an alarm or a warning occurs, Thunder main window will monitor and respond in real-time.

Error log

Error log provides the detailed descriptions of alarm, possible causes and corrective actions. Besides, it can also save and track the history of alarm.

8.2 Real-time monitoring

8.2.1 Brief introduction

Real-time monitoring mainly checks if there are abnormal signals triggered in servo drive. Some are alarm signals must be immediately dealt with; some are warning signals do not need to be immediately dealt with but with high risk. The differences of these two kinds of signals, phenomena, causes and corrective actions.

Alarm monitoring

Alarm monitoring will stop the motor when an alarm is triggered, and the alarm will be displayed in Thunder main window in real-time.

Warning monitoring

Although warning monitoring will not immediately stop the motor when a warning is triggered, some warning types may trigger alarm signals. Compared to alarms, warnings are the notifications do not need to be immediately dealt with.

8.2.2 Alarm monitoring

When servo drive triggers an alarm signal, Thunder main window will display a flashing red message in real-time. The motor will be immediately disabled. At this time, users must deal with it immediately. Refer to section 13.2 in “E1 Series Servo Drive User Manual” for the detailed alarm types, phenomena and corrective actions. As for motor stopping methods for alarm, refer to section 6.9.2 “E1 Series Servo Drive User Manual”.

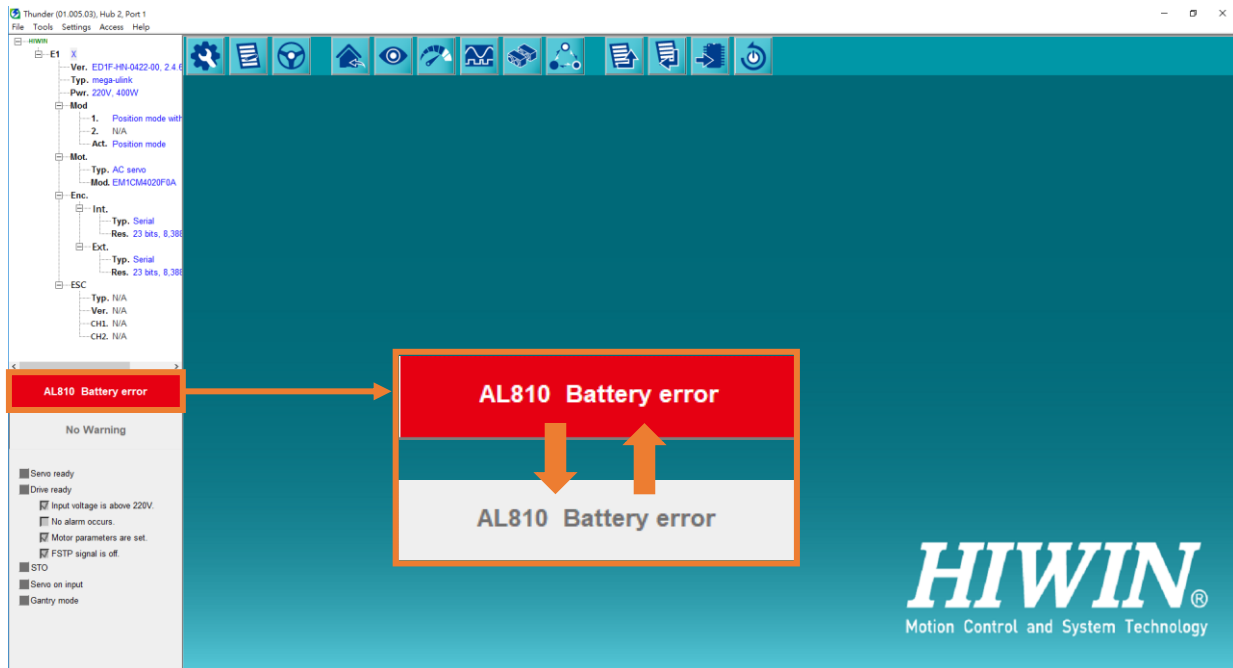

Figure 8.2.2.1

8.2.3 Warning monitoring

When servo drive triggers a warning signal, Thunder main window will display a flashing yellow message in real-time. Compared to triggering an alarm signal, triggering a warning signal belongs to the notification does not need to be immediately dealt with. However, high-risk abnormal phenomenon may still occur. Refer to section 13.3 in “E1 Series Servo Drive User Manual” for the detailed warning types, phenomena and corrective actions.

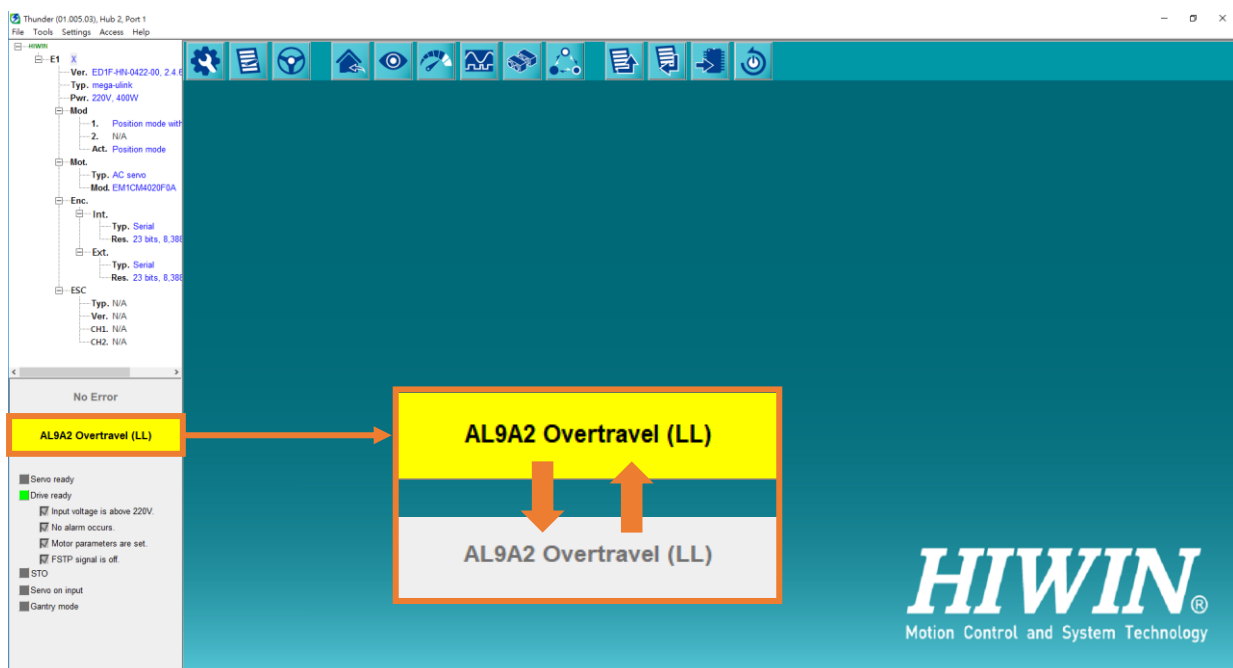

Figure 8.2.3.1

8.3 Error log

Follow the procedure below to open “Error log” window and learn how to perform the functions in the interface.

1. To open “Error log” window, select **Tools** in the menu bar and click **Error log**, or directly click the flashing red message in Thunder main window.

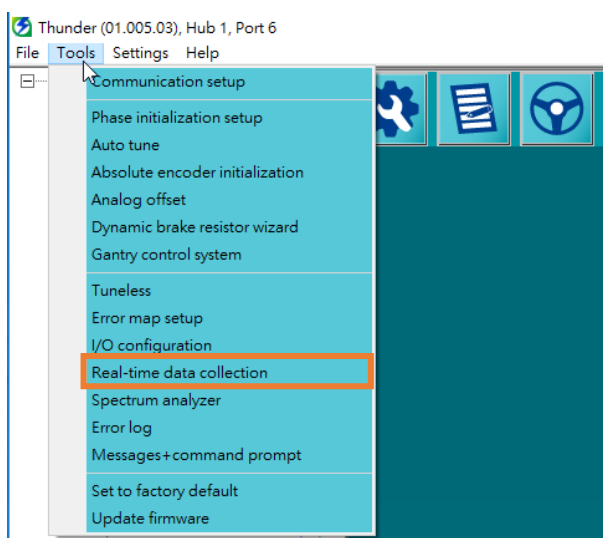

Figure 8.3.1

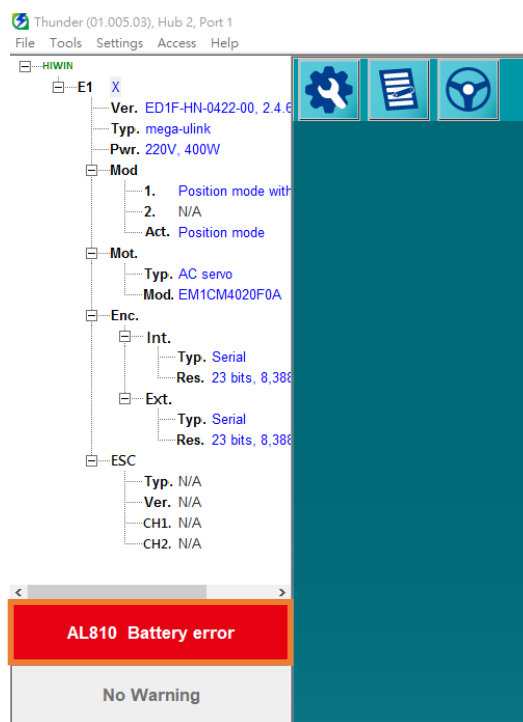

Figure 8.3.2

2. Each triggered alarm will be recorded in “Error log” window. If the interval of the same triggered alarm is less than one hour, the alarm will only be recorded once; if the interval exceeds one hour, the alarm will be recorded in History.

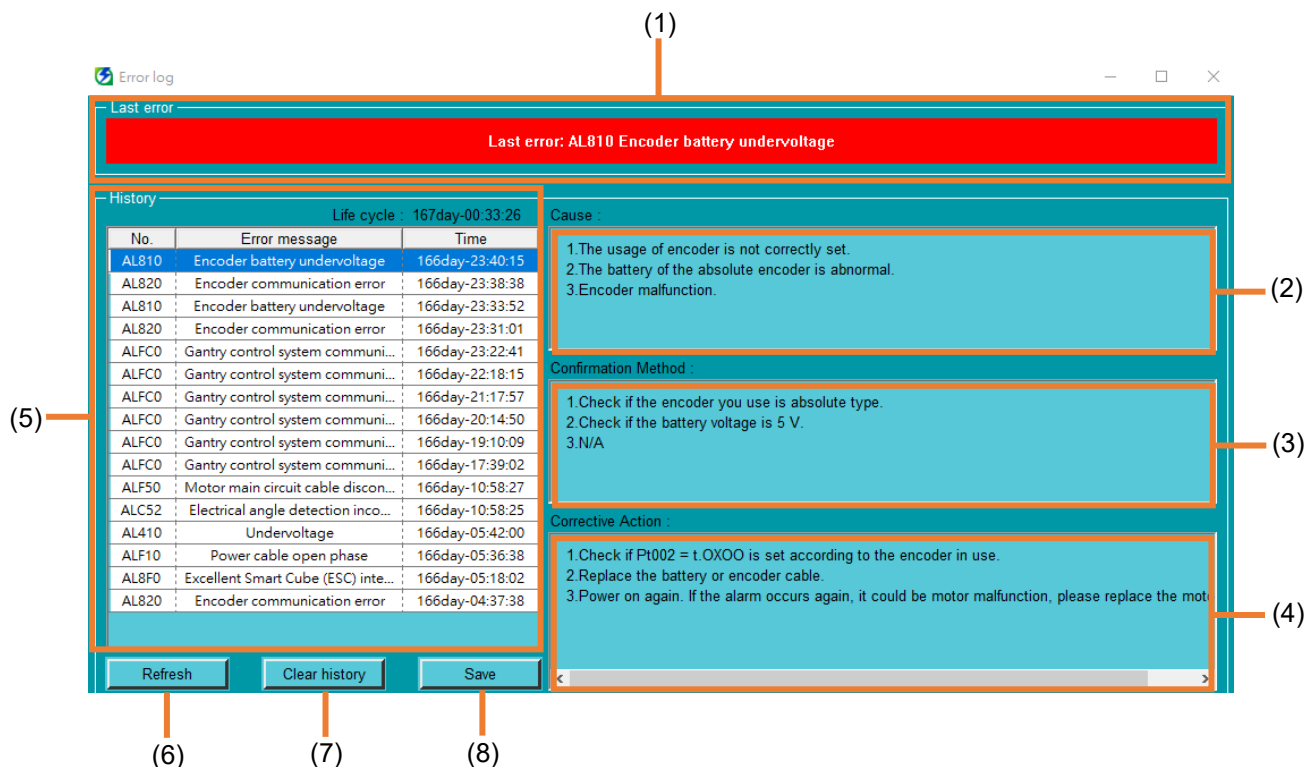



Figure 8.3.3

Table 8.3.1

No.	Item	Description
(1)	Last error	Display the current alarm code.
(2)	Cause	Show all the causes which may trigger the alarm.
(3)	Confirmation method	Users should check if software or hardware is correctly set based on Cause.
(4)	Corrective action	If the alarm still cannot be eliminated after confirmation, follow the corrective actions here to eliminate the alarm.
(5)	History	<p>Life cycle: Record the total time cumulated during the power-on time of servo drive.</p> <p>No.: The alarm code displayed in servo drive.</p> <p>Error message: The message of alarm code.</p> <p>Time: The time that the alarm is triggered.</p> <p> History can only display the latest 16 alarm messages at most.</p> <p>Information</p>

(6)	Refresh	Update the information of History.
(7)	Clear history	Clear all the alarm messages in History.
(8)	Save	Save the current alarm messages as a text file.



Example

Take Figure 8.3.3 as an example:

Life cycle : 167day-00:33:26

The cumulative power-on time of servo drive is 167 days, 0 hours, 33 minutes and 26 seconds.

No.	Error message	Time
AL810	Encoder battery undervoltage	166day-23:40:15

Alarm code (No.): AL810

Alarm message (Error message): Encoder battery undervoltage

Trigger time (Time):

The cumulative power-on time of servo drive is 166 days, 23 hours, 40 minutes and 15 seconds.

(This page is intentionally left blank.)

9. Advanced Functions

9.	Advanced Functions.....	9-1
9.1	Brief introduction.....	9-3
9.2	Multi-motion setting.....	9-3
9.2.1	Brief introduction	9-3
9.2.2	Preparation.....	9-5
9.2.3	Set multi-motion parameters.....	9-6
9.2.4	Send multi-motion parameters to servo drive and activate multi-motion function	9-11
9.2.5	Read multi-motion parameters from servo drive.....	9-12
9.2.6	Load multi-motion parameters file (*.mtk).....	9-13
9.2.7	Save multi-motion parameters file (*.mtk).....	9-14
9.2.8	Clear multi-motion parameters and disable multi-motion function.....	9-15
9.2.9	Instructions for customized motion	9-16
9.3	Absolute encoder initialization	9-19
9.3.1	Brief introduction	9-19
9.3.2	Interface introduction	9-20
9.3.2.1	Message field.....	9-21
9.4	Analog offset.....	9-22
9.4.1	Brief introduction	9-22
9.4.2	Interface introduction	9-22
9.5	PDL.....	9-24
9.5.1	Brief introduction	9-24
9.5.2	Open PDL	9-25
9.5.3	Compile and save PDL	9-26
9.6	Error map setup	9-28
9.6.1	Brief introduction	9-28
9.6.2	Error map setup	9-29
9.6.2.1	Error map information setting	9-30
9.6.2.2	Load error map	9-32
9.6.2.3	Save / Read error map	9-33
9.6.3	Activate error map.....	9-35
9.7	Gantry control system.....	9-36
9.7.1	Brief introduction	9-36
9.7.2	Preparation.....	9-37
9.7.3	Gantry setting.....	9-38
9.8	Dynamic brake resistor wizard	9-41
9.8.1	Brief introduction	9-41

9.8.2	Motor parameters setting	9-42
9.8.2.1	Motor parameters	9-44
9.8.2.2	HIWIN motor	9-45
9.8.2.3	Read parameters	9-46
9.8.2.4	Other brand motor	9-47
9.8.3	Application parameters setting	9-48
9.8.4	Calculation results	9-50
9.8.5	Save / Load	9-54

9.1 Brief introduction

The special functions supported by Thunder are introduced in this chapter. Users can use them based on different situation. The setting methods and timing of usage will be explained as below.

9.2 Multi-motion setting

9.2.1 Brief introduction

Multi-motion applications, such as food filling and food sorting, can be achieved by this function. With a few input signals, multi-motion movement can be performed. “Multi-motion setting” window allows users to set motion number, the corresponding input pin of each motion, type and other parameters. After the setting is done, users can save multi-motion parameters to servo drive or as multi-motion parameters file (*.mtk), read multi-motion parameters from servo drive, or load multi-motion parameters file (*.mtk) from file.



Important

- (1) This function is available for direct drive motor (DM), torque motor (TM) and linear motor (LM).
- (2) It is applicable to Thunder 1.4.8.1 and firmware version 2.4.6 or above.
- (3) After the function is used, **PDL** can only support up to 1 task.

The steps to set multi-motion parameters and activate multi-motion function are given as below.

Table 9.2.1.1

Step	Description	Reference
1	Preparation Configure input pins and set electronic gear ratio and control mode.	section 9.2.2
2	Set multi-motion parameters Set motion number, type and motion parameters.	section 9.2.3
3	Send to drive Save parameters to servo drive and activate multi-motion function.	section 9.2.4

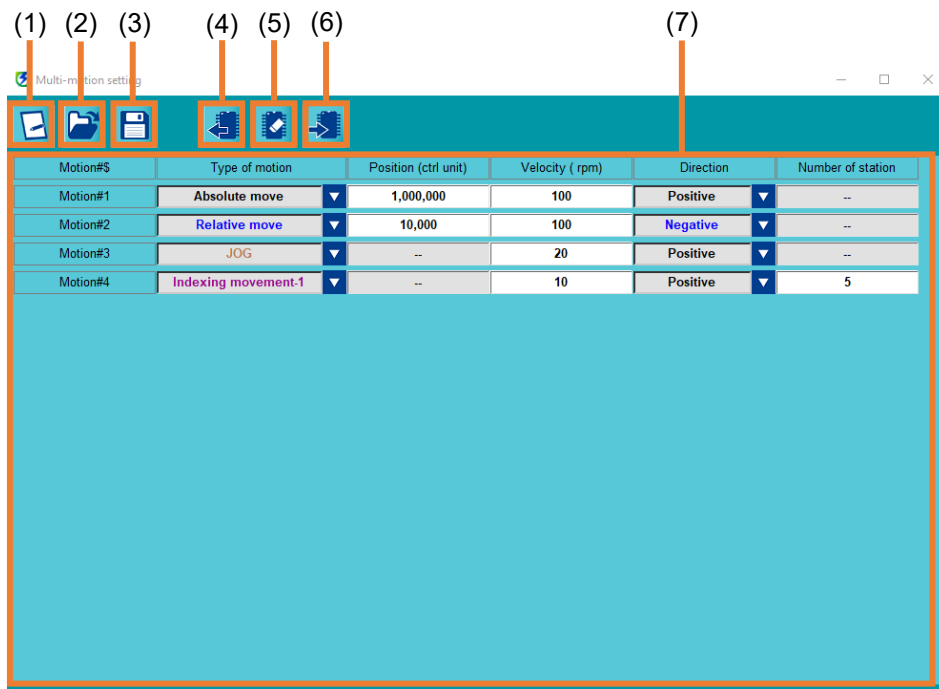

Figure 9.2.1.1

Table 9.2.1.2

No.	Item	Description	Reference
(1)	New or Modify	Add or modify motion number and the configuration of input pins.	section 9.2.3
(2)	Load from file	Load multi-motion parameters file (*.mtk).	section 9.2.6
(3)	Save as a file	Save the set multi-motion parameters as multi-motion parameters file (*.mtk).	section 9.2.7
(4)	Read from drive	Read and display the multi-motion parameters saved in servo drive.	section 9.2.5
(5)	Clear data	Clear the multi-motion parameters saved in servo drive and disable multi-motion function.	section 9.2.8
(6)	Send to drive	Save the set multi-motion parameters to servo drive and activate multi-motion function.	section 9.2.4
(7)	Multi-motion parameters setting	Users can set type of motion and parameters here.	section 9.2.3

9.2.2 Preparation

Follow the procedure below to complete preparation.

- Once motion number is decided, users can get the number of input pins to be set. The following table shows the relationship of motion number and the number of input pins to be set.

Table 9.2.2.1

Motion number	Number of input pins to be set
1	2
2 ~ 3	3
4 ~ 7	4
8 ~ 15	5
16 ~ 31	6
32 ~ 63	7
64	8

- Go to “I/O configuration” window and set all the input pins for multi-motion function as **Not configure**. Refer to **I/O configuration** or section 15.2.6 in “E1 Series Servo Drive User Manual” for the setting method.

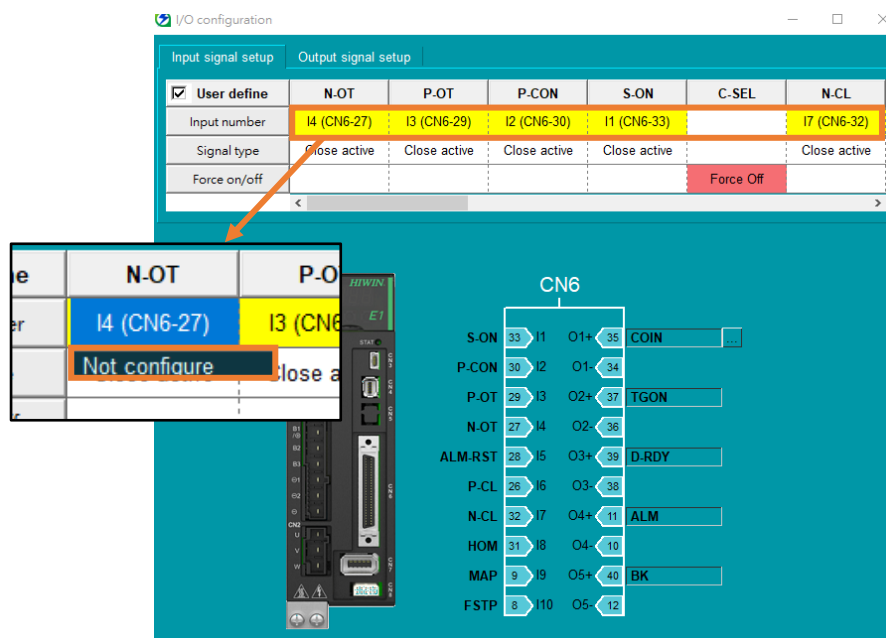

Figure 9.2.2.1



Important

This function can only be operated when the motor is enabled. Therefore, users must save an input pin for **S-ON**.

- Set both numerator and denominator of electronic gear ratio (Pt20E, Pt210) as **1**, and set control mode (Pt000.□□X□) as **A (Internal position mode)**. Refer to Parameters Setup for the setting method.

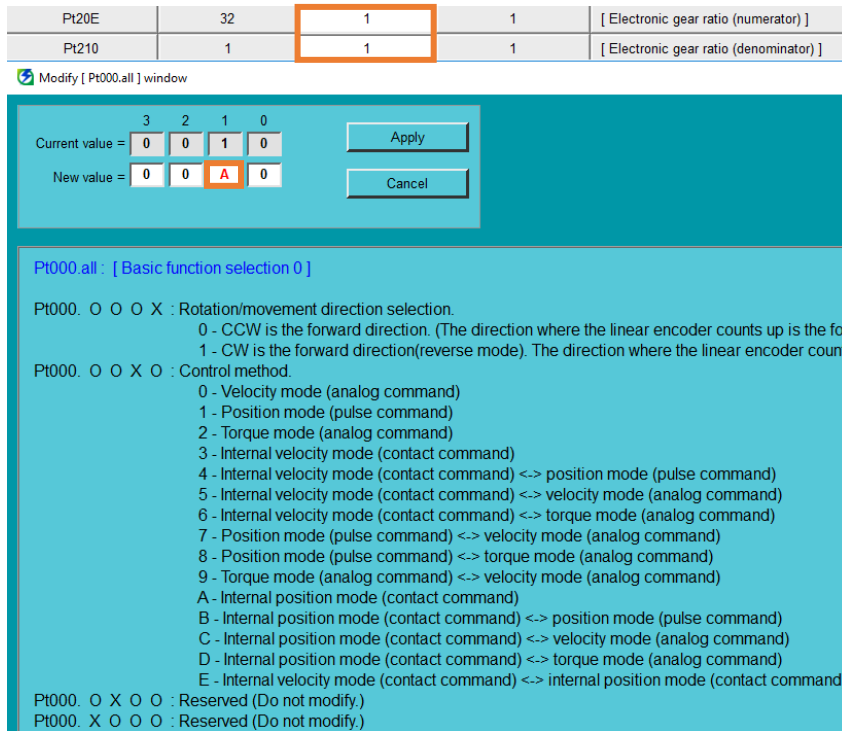

Figure 9.2.2.2

9.2.3 Set multi-motion parameters

Follow the procedure below to set multi-motion parameters.

- Click “Open multi-motion setting” icon in the toolbar.

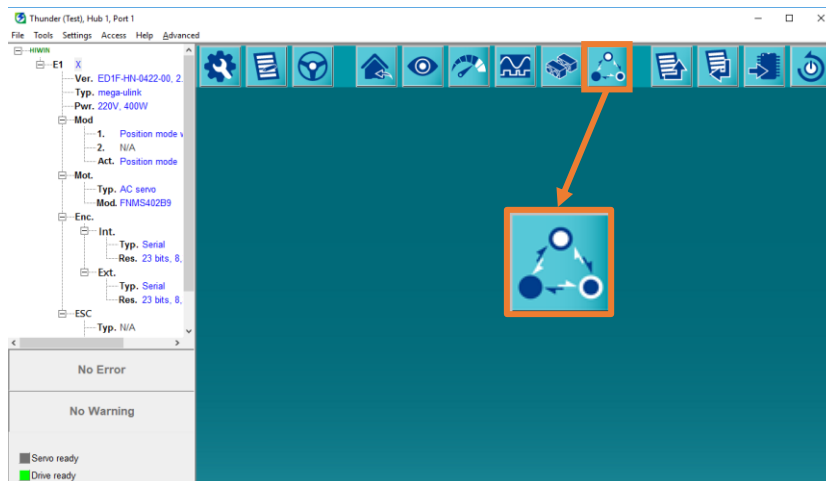



Figure 9.2.3.1

- Click “New or Modify” icon  to open “Set motion number and specify input signal” window. After keying in “Motion number”, the signal configuration corresponding to each motion will be automatically generated.

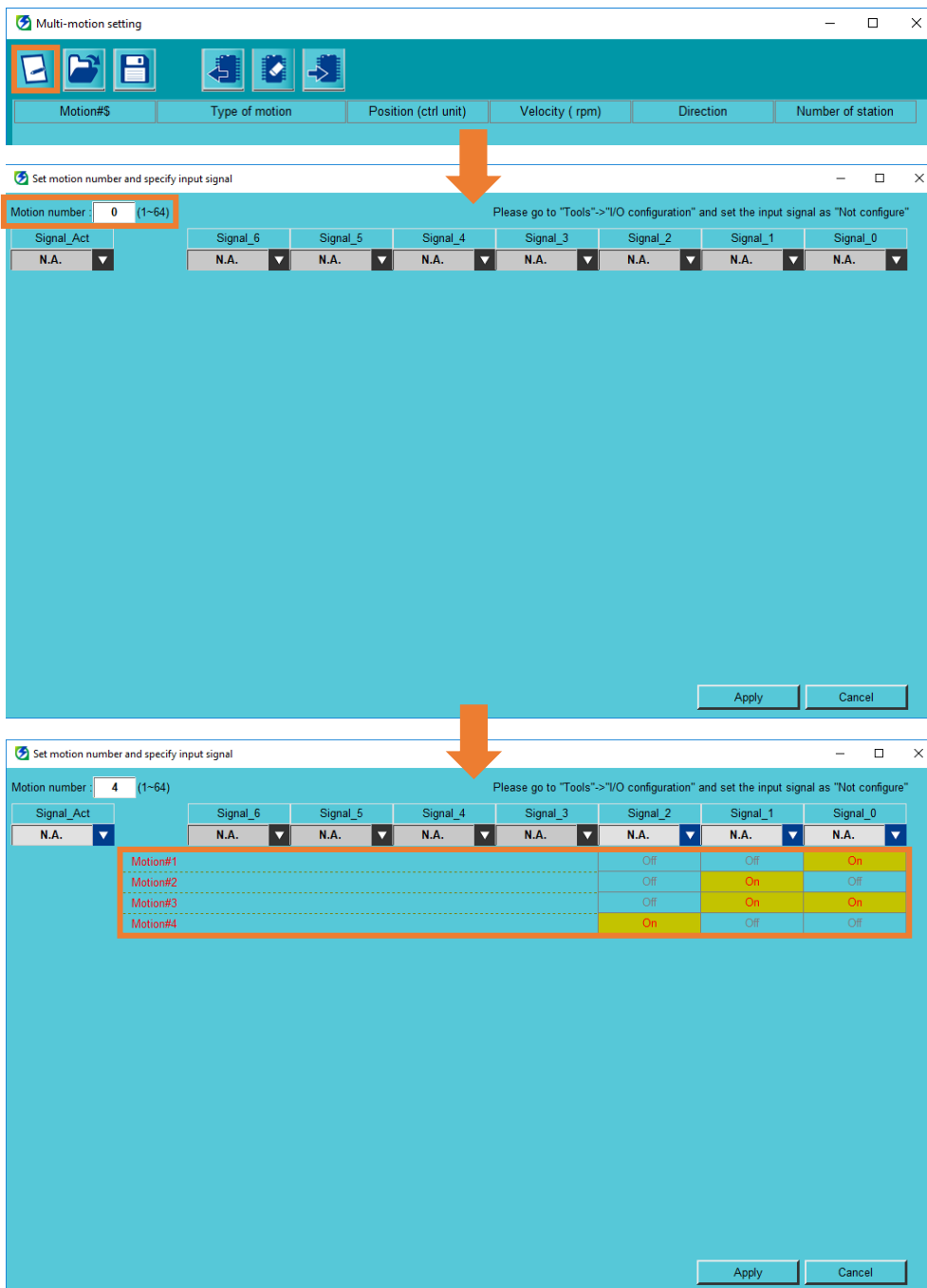

Figure 9.2.3.2

- Assign input pins of “Signal_Act” and “Signal_0~6”.

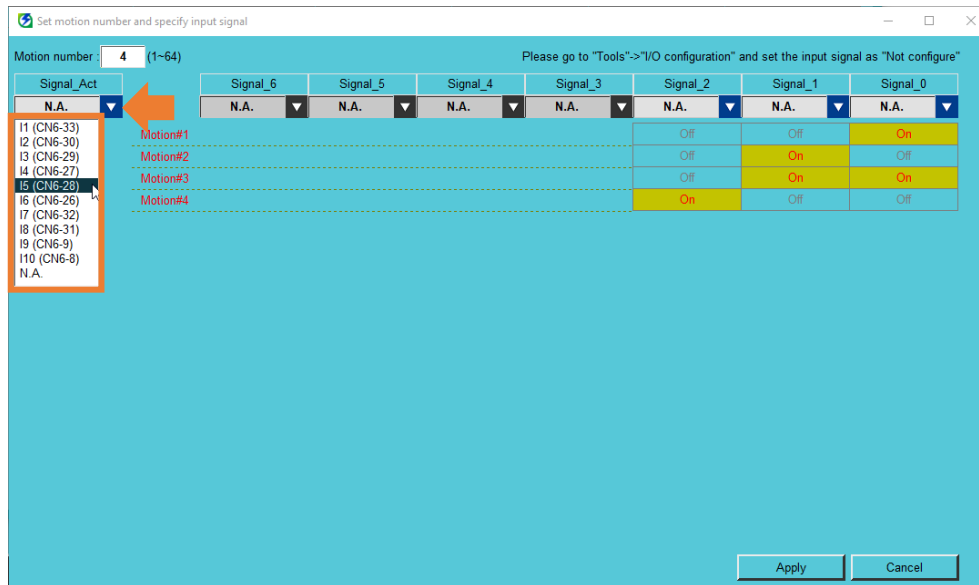

Figure 9.2.3.3

4. After the setting is done, click **Apply**.

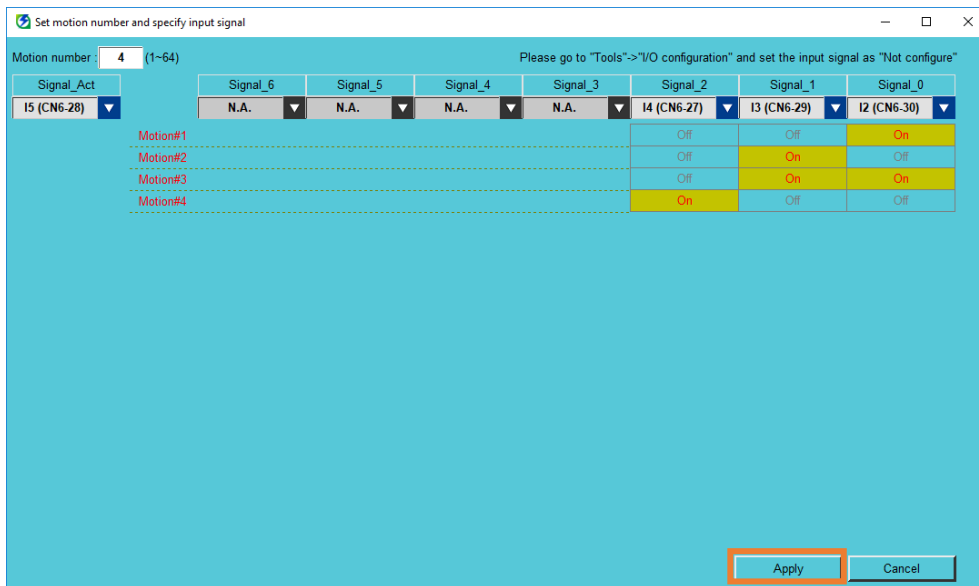

Figure 9.2.3.4

5. An information window will pop up. Click **OK** and check if there is a conflict in input signal configuration.

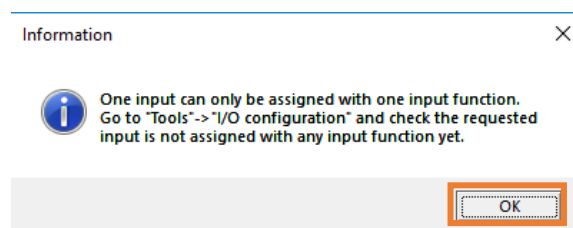

Figure 9.2.3.5

6. After the signal configuration is done, the window will generate the corresponding motion number. The default of each motion is **N.A.**.

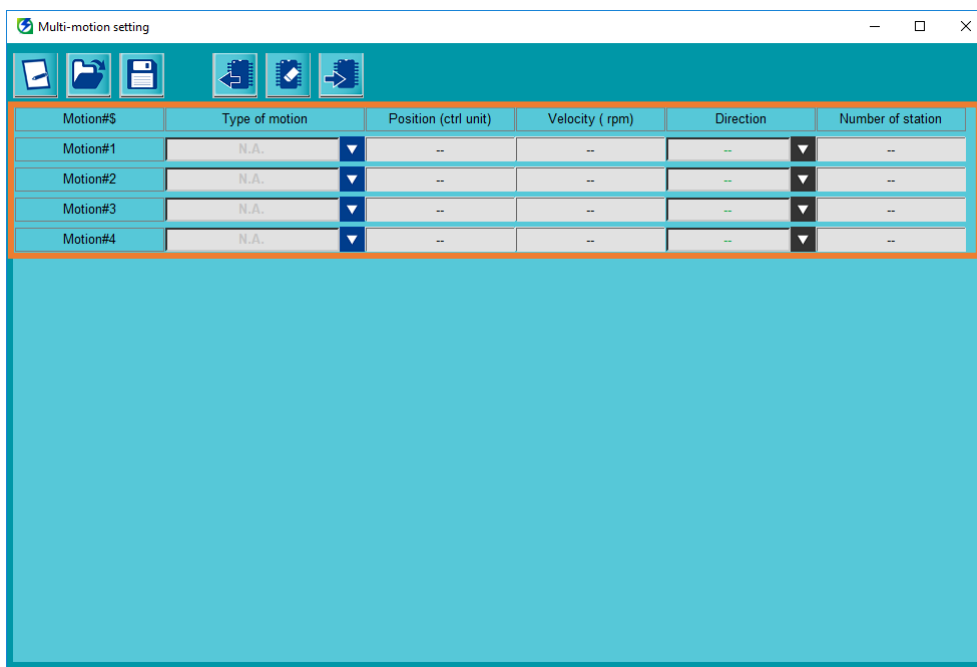

Figure 9.2.3.6

7. Select type of motion and set the corresponding parameters.

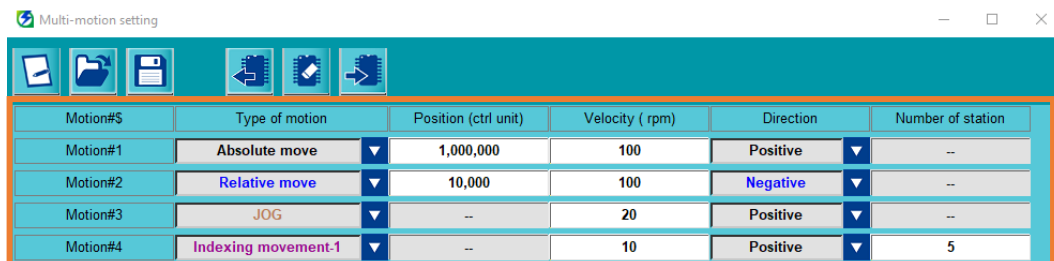

Figure 9.2.3.7

Table 9.2.3.1

Type of motion	Position	Velocity	Direction	Number of station
Absolute move	V	V	V	--
Relative move	V	V	V	--
Indexing movement-1	--	V	V	V
Indexing movement-2	--	V	V	V
JOG	--	V	V	--
Homing	--	--	--	--
Customized motion	--	--	--	--

V: Need to key in or select the parameter.

--: No need to key in or select the parameter.



Important

- (1) JOG is “high level trigger”, while others are “rising edge trigger”.
- (2) Linear motor only supports Absolute move, Relative move, JOG, Homing and Customized motion; it does not support Indexing movement.



Information

Position and velocity support **Display unit setting** function. The corresponding values will be displayed based on the display unit selected by users.



Term

- (1) **Absolute move:** Move the motor to the position specified by users with the velocity and direction specified by users.
- (2) **Relative move:** Move the motor for a distance specified by users with the velocity and direction specified by users.
- (3) **Indexing movement:** The position of each station will be automatically calculated by the number of station specified by users. After the command is triggered, the motor will move to the next station with the velocity and direction specified by users.
- (4) **Indexing movement-1:** If the motor is disabled and moved to other position during indexing movement, the first command after the motor is re-enabled will move the motor to the last target station.
- (5) **Indexing movement-2:** If the motor is disabled and moved to other position during indexing movement, the first command after the motor is re-enabled will move the motor to the next station closest to the current position.
- (6) **Homing:** If incremental encoder is used, its homing method is the same as the homing method set in section 5.3.
- (7) **Customized motion:** Users can edit motion process in user.pdl based on the example format (refer to section 9.2.9). After the command is triggered, the motor will do the movement based on the motion process designed by users.



Example

Take four stations and 90 degrees movement as the motion planning. When the servo drive receives the command and moves the motor from 0 degree to 90 degrees, the motor is disabled due to an error. During troubleshooting, the motor is accidentally moved to the range between 90 to 180 degrees. When the motor is re-enabled and the command is given:

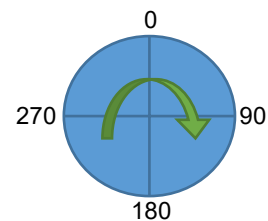

- ◆ Indexing movement-1 will remember the last target station, so it will go back to 90 degrees.
- ◆ Indexing movement-2 will move to 180 degrees, the next station for the current position.

9.2.4 Send multi-motion parameters to servo drive and activate multi-motion function

Follow the procedure below to save the set multi-motion parameters to servo drive and activate multi-motion function.

1. Click "Send to drive" icon .

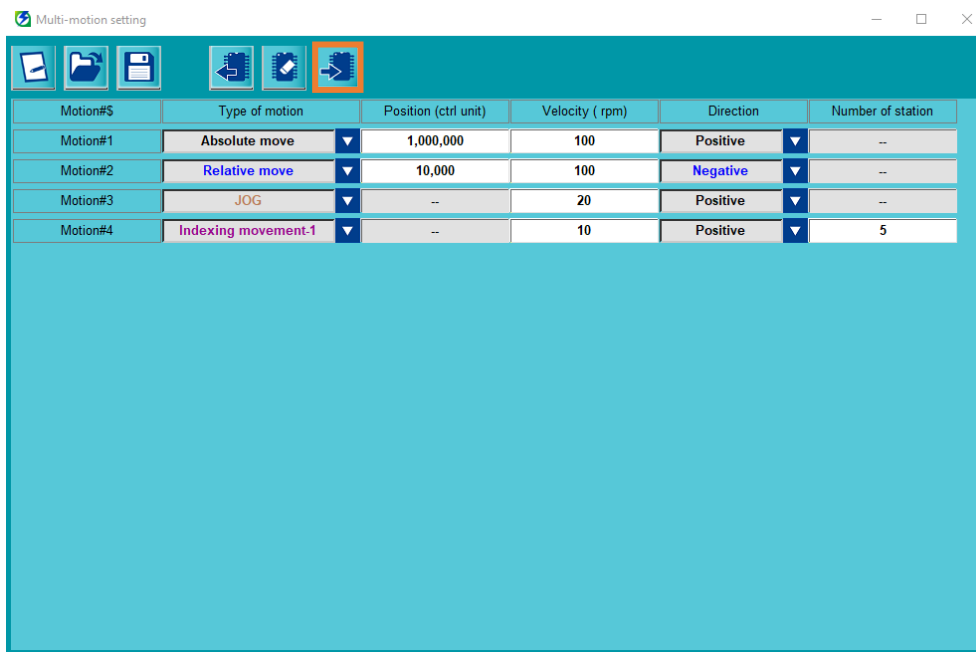

Figure 9.2.4.1

2. Read the message window and click **Yes**. At this time, the servo drive will automatically change electronic gear ratio to **1:1** and control mode to **Internal position mode**.

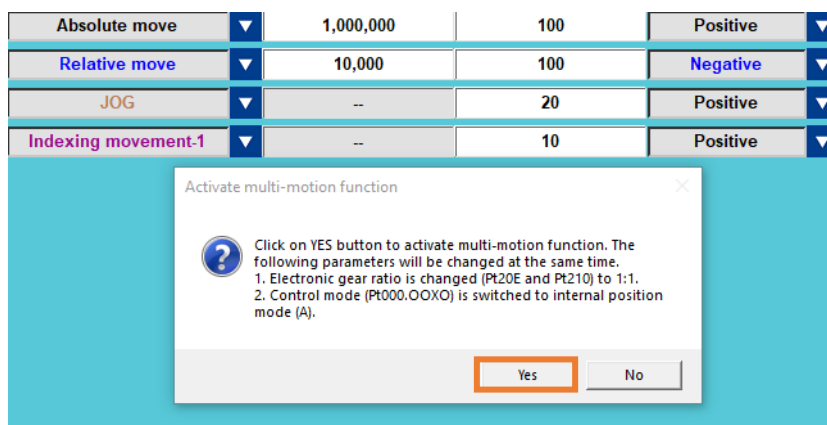

Figure 9.2.4.2

- After the servo drive is power cycled, “Activate multi-motion function success!” window will pop up. After users click **OK**, the data will be successfully saved to servo drive and multi-motion function will be activated.

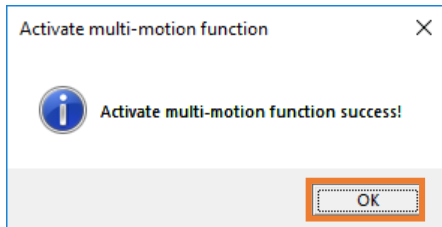



Figure 9.2.4.3

9.2.5 Read multi-motion parameters from servo drive

Click “Read from drive” icon  to read and display the multi-motion parameters saved in servo drive. Users can modify motion number, the configuration of input pins, type of motion and other motion parameters before saving them to servo drive again.

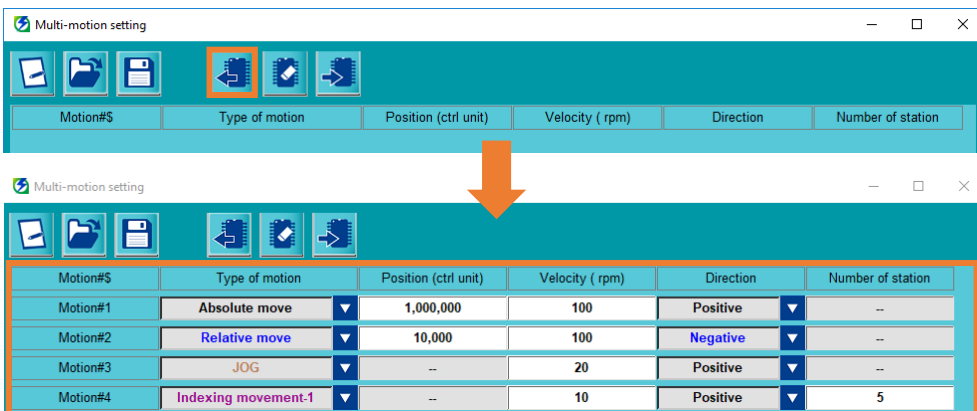

Figure 9.2.5.1

9.2.6 Load multi-motion parameters file (*.mtk)

Load multi-motion parameters and display them on “Multi-motion setting” window.

1. Click “Load from file” icon .

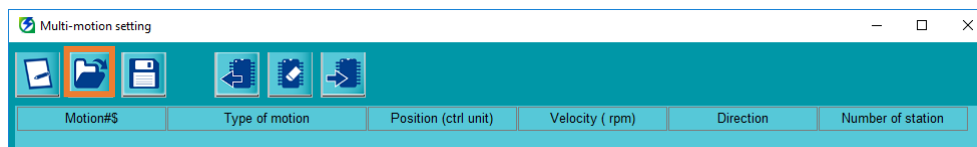

Figure 9.2.6.1

2. Select multi-motion parameters file (*.mtk), and click **Open**.

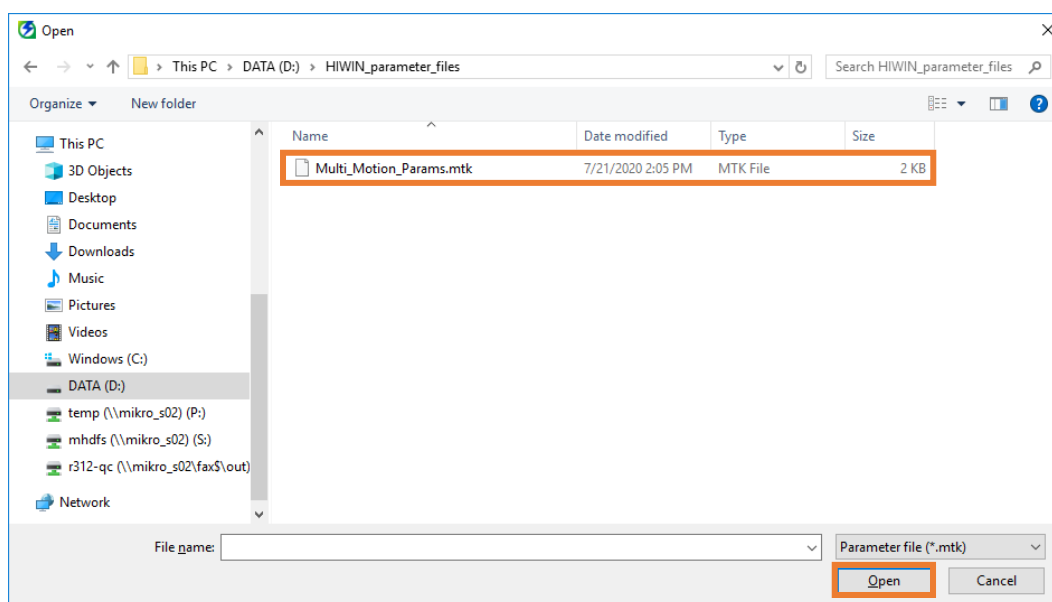



Figure 9.2.6.2

9.2.7 Save multi-motion parameters file (*.mtk)

Save the set multi-motion parameters as multi-motion parameters file (*.mtk).

1. Click "Save as a file" icon .

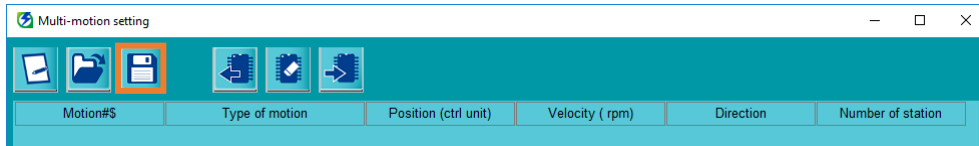

Figure 9.2.7.1

2. Key in file name of multi-motion parameters file (*.mtk), select archive path, and click **Save**.

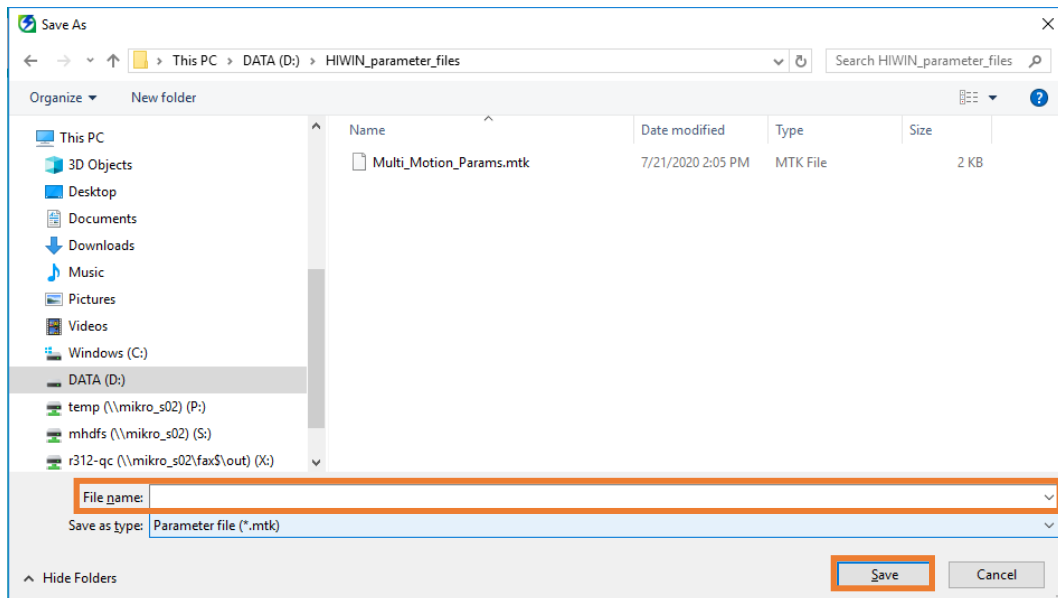



Figure 9.2.7.2

9.2.8 Clear multi-motion parameters and disable multi-motion function

Clear the multi-motion parameters saved in servo drive and disable multi-motion function.

1. Click “Clear data” icon .

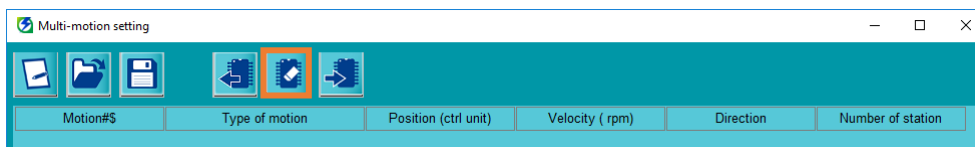

Figure 9.2.8.1

2. Read the message window and click **Yes**. At this time, the servo drive will be power cycled.

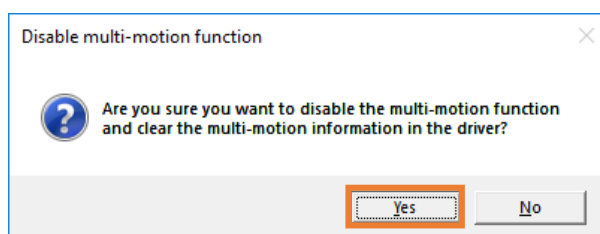

Figure 9.2.8.2

3. After the servo drive is power cycled, “Disable multi-motion function success!” window will pop up. After users click **OK**, the multi-motion parameters saved in servo drive will be successfully cleared and multi-motion function will be disabled.

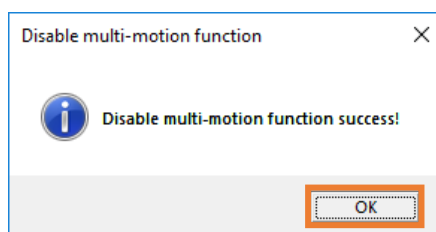

Figure 9.2.8.3

9.2.9 Instructions for customized motion

Follow the procedure below to use customized motion.



Important

It is applicable to Thunder 1.6.11.0 and firmware version 2.6.11 or above.

1. Refer to section 9.2.3 and 9.2.4 to activate multi-motion function.
2. Copy the example format below to **PDL** editing window.

```

/*The customized PDL sample for multi-motion function*/
#define INIT 0
#define RUN 1
#define END 2
/*Each motion number should be the same as the multi-motion setting in Thunder.*/
#define motion1 1
#define motion2 2
#define motion3 3
#define motion4 4
/*-----main-----*/
#task/01;
MotionSample:
    till(CsMotion_Flag = RUN);
    if(MotionSel = motion1)do
        /*Motion process
        Do something*/
        CsMotion_Flag = END;
    end;
    if(MotionSel = motion2)do
        /*Motion process
        Do something*/
        CsMotion_Flag = END;
    end;
    if(MotionSel = motion3)do
        /*Motion process
        Do something*/
        CsMotion_Flag = END;
    end;

```

```

if(MotionSel = motion4)do
  /*Motion process
  Do something*/
  CsMotion_Flag = END;
end;
goto MotionSample;
ret;

```



- (1) CsMotion_Flag is the flag to judge the motion status; 0 indicates no motion, 1 indicates in motion, and 2 indicates motion ends.
- (2) MotionSel is the motion number set in “Multi-motion setting” window.

3. Modify #define motion1 1 and so on in sequence to make them be the same as the motion number in “Multi-motion setting” window.

Motion#s	Type of motion	Position (ctrl unit)	Velocity (rpm)	Direction	Number of station
Motion#1	Absolute move	10,000	60	Shortest path	--
Motion#2	Relative move	5,000	60	Positive	--
Motion#3	JOG	--	--	--	--
Motion#4	Homing Operation	--	--	--	--
Motion#5	Indexing movement-1	--	--	--	--
Motion#6	Indexing movement-2	--	--	--	--
Motion#7	Customized motion	--	--	--	--
Motion#8	Customized motion	--	--	--	--
Motion#9	Customized motion	--	--	--	--
Motion#10	Customized motion	--	--	--	--

```

user.pdl
/*The customized PDL sample for multi-motion function*/
#define INIT 0
#define RUN 1
#define END 2
/*Each motion number should be the same as the multi-motion setting in Thunder.*/
#define motion7 7
#define motion8 8
#define motion9 9
#define motion10 10
/*-----main-----*/
#task/01;
MotionSample:
  till(CsMotion_Flag = RUN);
  if(MotionSel = motion7)do
    /*Motion process
    Do something*/
    CsMotion_Flag = END;
  end;
  if(MotionSel = motion8)do
    /*Motion process
    Do something*/
    CsMotion_Flag = END;
  end;
  if(MotionSel = motion9)do
    /*Motion process
    Do something*/
    CsMotion_Flag = END;
  end;
  if(MotionSel = motion10)do
    /*Motion process
    Do something*/
    CsMotion_Flag = END;
  end;
goto MotionSample;
ret;

```

Figure 9.2.9.1

4. Edit motion process based on the requirement.

```
user_pdl *
/*The customized PDL sample for multi-motion function*/
#define INIT 0
#define RUN 1
#define END 2
/*Each motion number should be the same as the multi-motion setting in Thunder.*/
#define motion7 7
#define motion8 8
#define motion9 9
#define motion10 10
/*-----main-----*/
#task/01:
MotionSample:
till(CsMotion_Flag = RUN);
if(MotionSel = motion7)do
/*Motion process
Do something*/
CsMotion_Flag = END;
end;
if(MotionSel = motion8)do
/*Motion process
Do something*/
CsMotion_Flag = END;
end;
if(MotionSel = motion9)do
/*Motion process
Do something*/
CsMotion_Flag = END;
end;
if(MotionSel = motion10)do
/*Motion process
Do something*/
CsMotion_Flag = END;
end;
goto MotionSample;
ret;|
```

Figure 9.2.9.2

5. Refer to section 9.5.3 to compile and save PDL. After that, customized motion can be used.

9.3 Absolute encoder initialization

9.3.1 Brief introduction

When a system installed with absolute encoder is used for the first time, the absolute encoder must be initialized. After the absolute encoder has been initialized, encoder data and the related alarms will be reset.

In the following occasions, absolute encoder must be initialized.

- ◆ Perform tuning for the first time after a machine is installed. Or encoder extension cable has been removed from motor.
- ◆ Alarm AL800 (Encoder data backup error) occurs.
- ◆ Multi-turn absolute encoder is reset or its battery has been replaced.

CAUTION

- ◆ After multi-turn absolute encoder has been initialized, the home position of the machine will change. Therefore, the home position must be readjusted. If the home position is not readjusted, false operation may occur and cause injury or damage to the machine.



Important

- (1) Before performing encoder initialization, ensure the motor is disabled.
- (2) In the following occasions, there will be no multi-turn data (The multi-turn data is usually 0.). Initializing absolute encoder is not required. Alarms related to absolute encoder (AL800) will not occur.
 - ◆ Use single-turn absolute encoder or absolute optical (magnetic) scale.
 - ◆ Use multi-turn absolute encoder as single-turn absolute encoder (Pt002.□X□□ = 2).



Information

- (3) This function only supports EM1 series of AC servo motor.
- (4) This function will completely clear the multi-turn information of encoder. However, it will save the single-turn position and consider the rotary direction of motor. Therefore, users must pay attention to the setting value of the rotary direction of motor (Pt000.□□□X).

9.3.2 Interface introduction

Select **Tools** in the menu bar and click **Absolute encoder initialization** to open “Absolute encoder initialization” window.

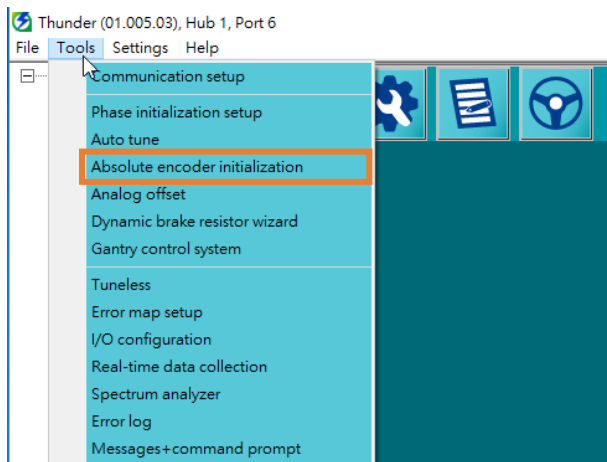

Figure 9.3.2.1

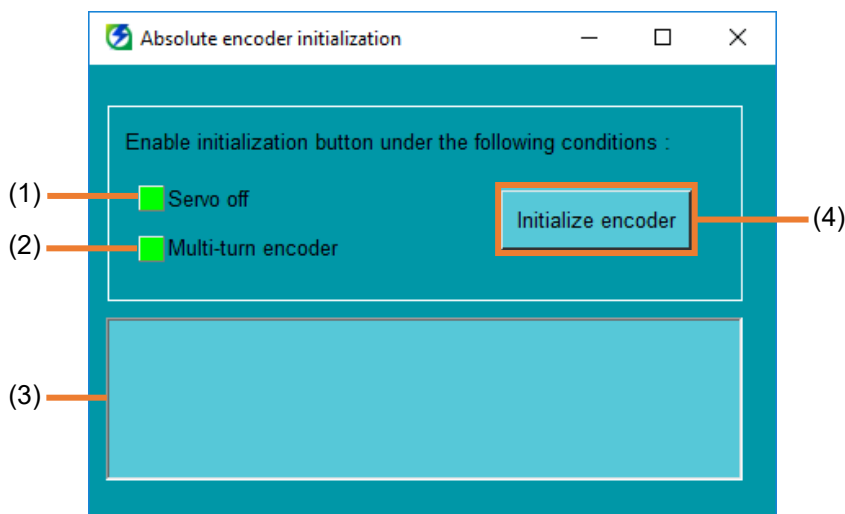

Figure 9.3.2.2

Table 9.3.2.1

No.	Item	Description	Reference
(1)	Servo off	When it lights up in green, the servo drive is at “Servo OFF” state.	--
(2)	Multi-turn encoder	When it lights up in green, the encoder type is multi-turn encoder.	--
(3)	Message field	Display the messages for the process of encoder initialization.	section 9.3.2.1
(4)	Initialize encoder	Click Initialize encoder to perform encoder initialization.	--

9.3.2.1 Message field

After users click **Initialize encoder** and encoder initialization succeeds, **Ok. Encoder is already initialized.** will be displayed in message field.

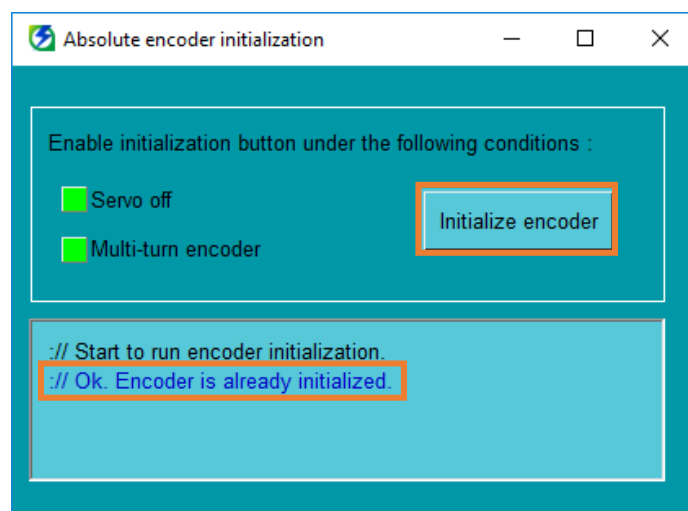

Figure 9.3.2.1.1

9.4 Analog offset

9.4.1 Brief introduction

On velocity or torque mode, even if velocity or torque command is 0 V, the motor may slightly move. The reason is that a deviation occurs during the voltage detection in servo drive. This kind of deviation is called offset. When it happens, users can adjust the offset with this function. Refer to section 8.3.2 in “E1 Series Servo Drive User Manual” for the detailed descriptions.

9.4.2 Interface introduction

Follow the procedure below to adjust analog offset.

1. Select **Tools** in the menu bar and click **Analog offset** to open “Analog offset” window.

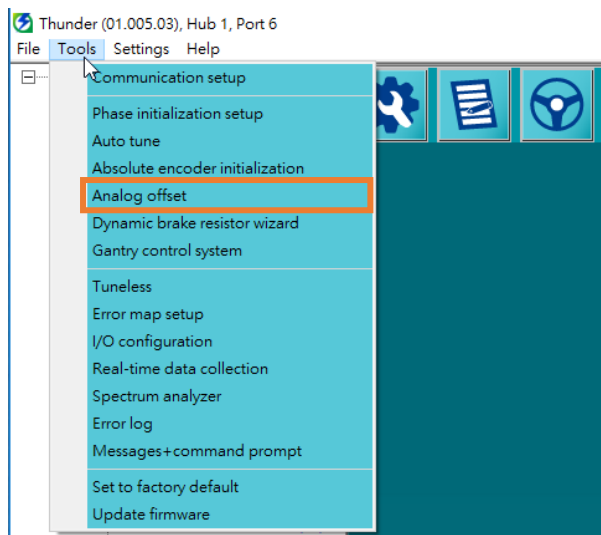

Figure 9.4.2.1

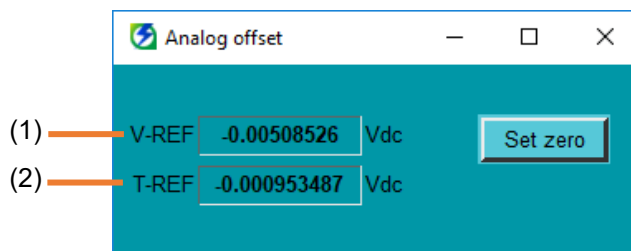

Figure 9.4.2.2

Table 9.4.2.1

No.	Item	Description	Reference
(1)	V-REF	Velocity command input signal	section 8.3.1 in "E1 Series Servo Drive User Manual"
(2)	T-REF	Torque command input signal	section 8.5.1 in "E1 Series Servo Drive User Manual"



Important

The measured offset must be saved to servo drive (Save to drive). Otherwise, users must adjust the offset again after servo drive is power-on again.



Important

The conditions for adjusting the offset:

- (1) The motor is disabled.
- (2) Host controller does not send any signal.

2. Click **Set zero**. The offset will be automatically adjusted.

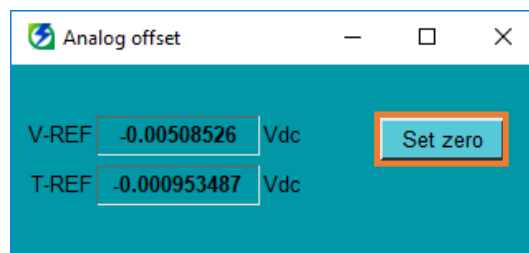

Figure 9.4.2.3

9.5 PDL

PDL (Process Description Language) is a programming language for users to develop motion control in servo drive. Users can edit self-defined motion control procedure (*.pdl) with PDL development-dedicated software, and download the examples from official website for reference.

9.5.1 Brief introduction

This section explains how to open PDL, compile PDL and save PDL to servo drive.

Open PDL

Open PDL development-dedicated software via Thunder.

Compile and save PDL

Compile and save PDL development-dedicated software.

9.5.2 Open PDL

Follow the procedure below to open PDL development-dedicated software.

Click “Open PDL” icon in the toolbar to open PDL editing window.

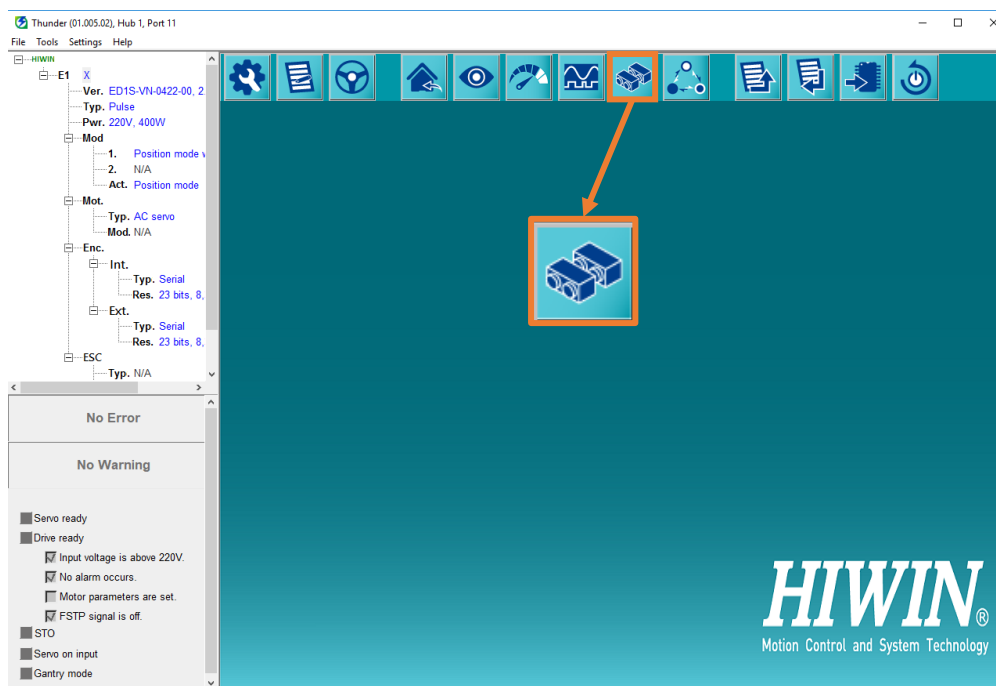

Figure 9.5.2.1

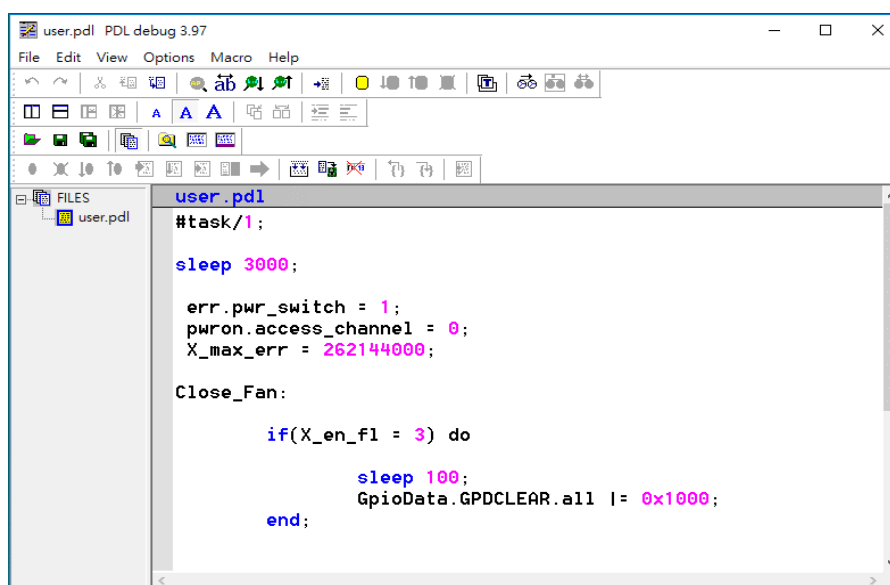

Figure 9.5.2.2

9.5.3 Compile and save PDL

After users complete self-defined motion control procedure (*.pdl), follow the procedure below to compile and save PDL.

1. Click "Compile" icon  to perform program compiling.

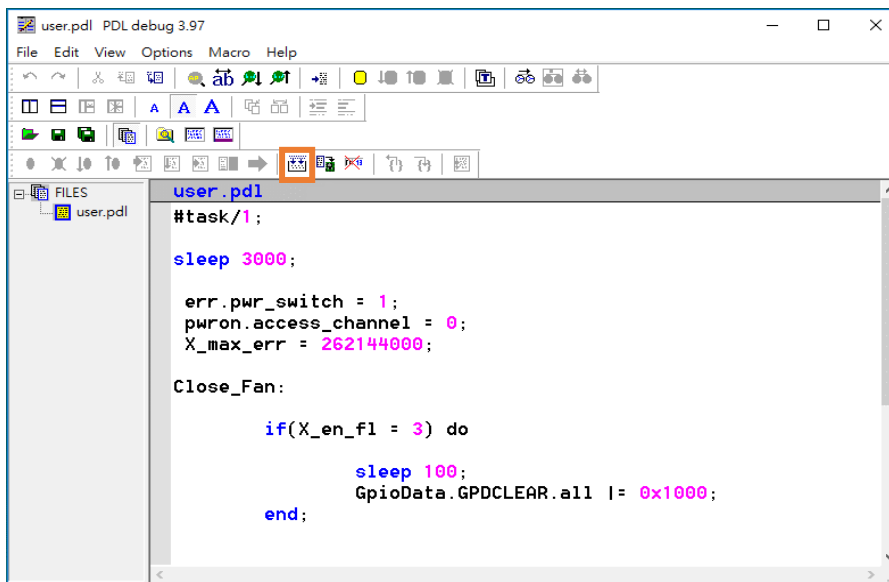

Figure 9.5.3.1

2. During the compiling process, a new window will pop up. **Compilation ended successfully** will appear after the compilation is successfully done.

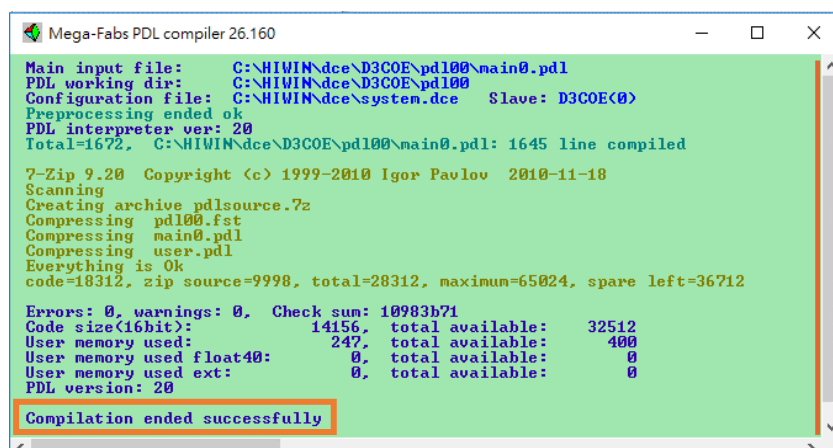

Figure 9.5.3.2



Information

If the compilation fails, the new window will display the error information with red words.

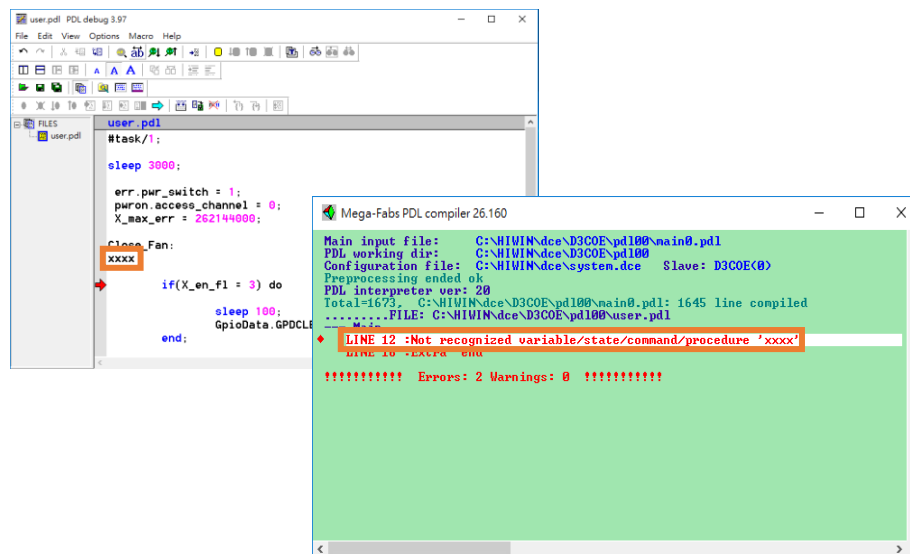

Figure 9.5.3.3

- After the compilation is successfully done, click “Save to slave” icon to save PDL to servo drive.

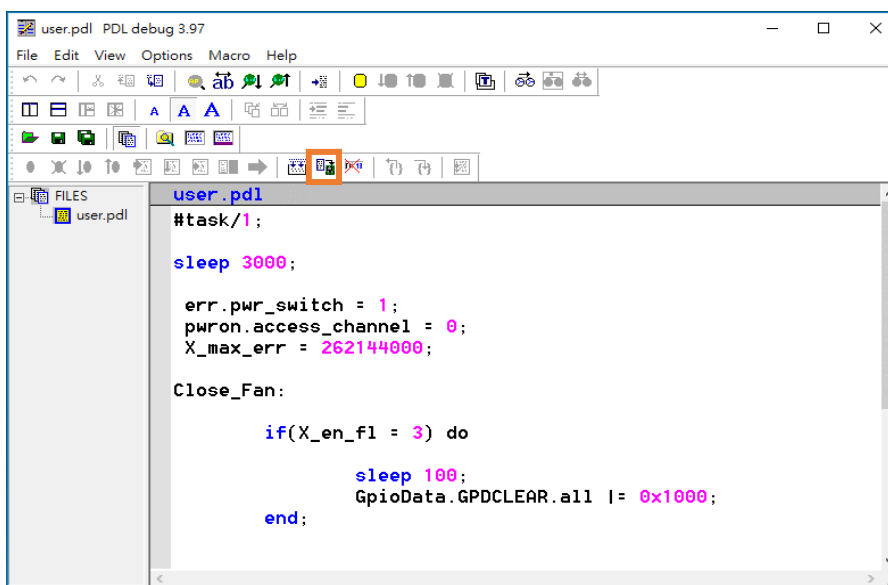

Figure 9.5.3.4

- Click **OK** in the new pop-up window. After the servo drive is power cycled, the saving is done.

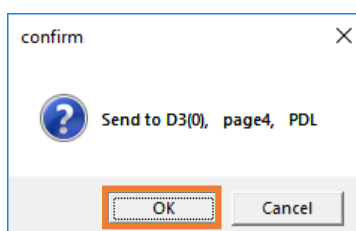

Figure 9.5.3.5

9.6 Error map setup

9.6.1 Brief introduction

The accuracy of positioning platform usually depends on the encoder in use. The accuracy is measured by laser interferometer and an error map can be obtained afterwards. E1 series servo drive provides error map function for users to save error map to servo drive via Thunder and load error map from servo drive.

DANGER

◆ To avoid unexpected actions, ensure the motor is disabled and remains static before saving error map to servo drive.



Information

- (1) Error map function can only be activated after homing is completed.
- (2) The servo drive calculates compensation values between fixed intervals by linear interpolation to increase positioning accuracy.

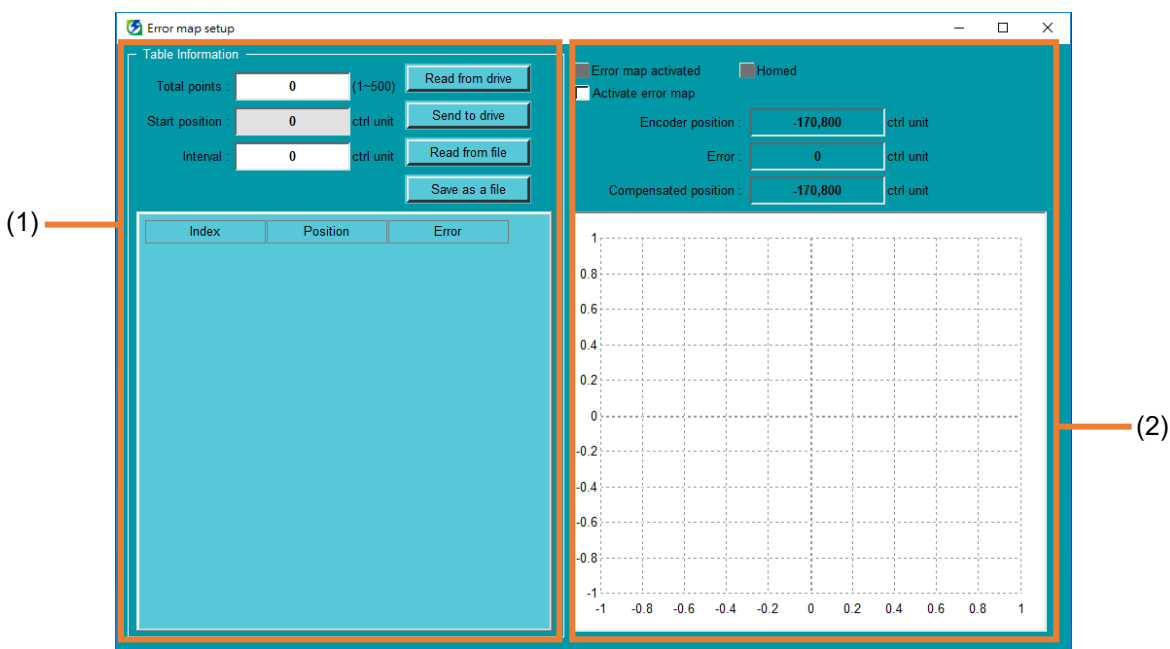

Figure 9.6.1.1

Table 9.6.1.1

No.	Item	Description	Reference
(1)	Information of error map	Set the information of error map.	section 9.6.2
(2)	Activate error map	Activate error map and observe error line chart.	section 9.6.3

9.6.2 Error map setup

Introduce the way to set, load, save and read error map.

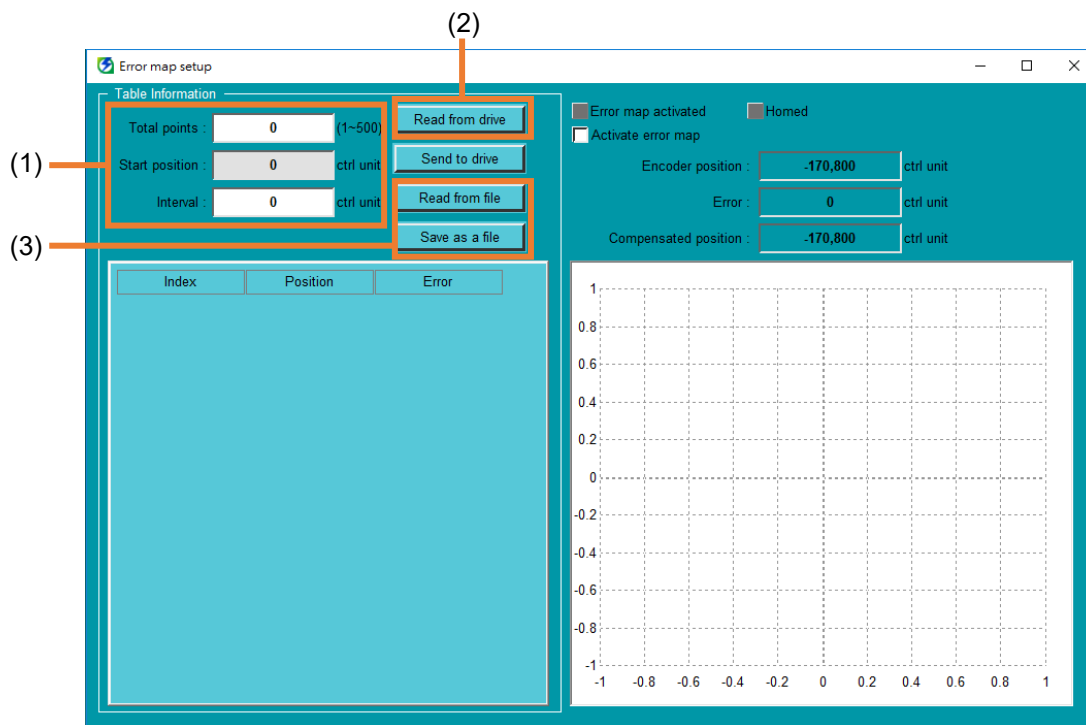

Figure 9.6.2.1

Table 9.6.2.1

No.	Item	Description	Reference
(1)	Error map setting	Set the information of error map.	section 9.6.2.1
(2)	Load error map	Load error map from servo drive.	section 9.6.2.2
(3)	Save / Read error map	Save or read error map.	section 9.6.2.3

9.6.2.1 Error map information setting

Follow the procedure below to complete error map information setting.

1. Select **Tools** in the menu bar and click **Error map setup** to open “Error map setup” window.

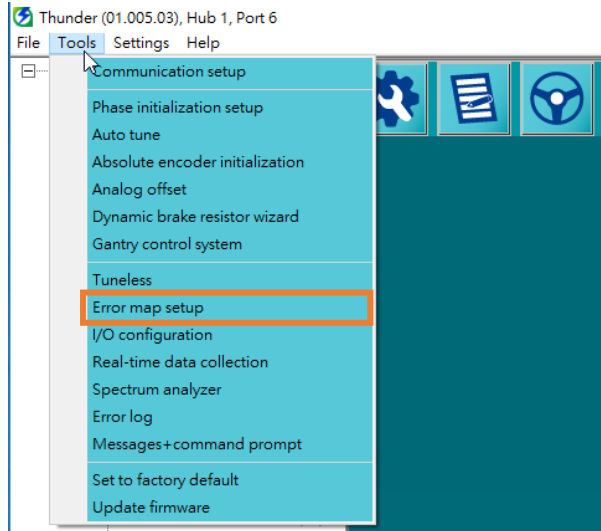

Figure 9.6.2.1.1

2. Key in **Total points** and **Interval**. The more the points, the better the positioning accuracy.

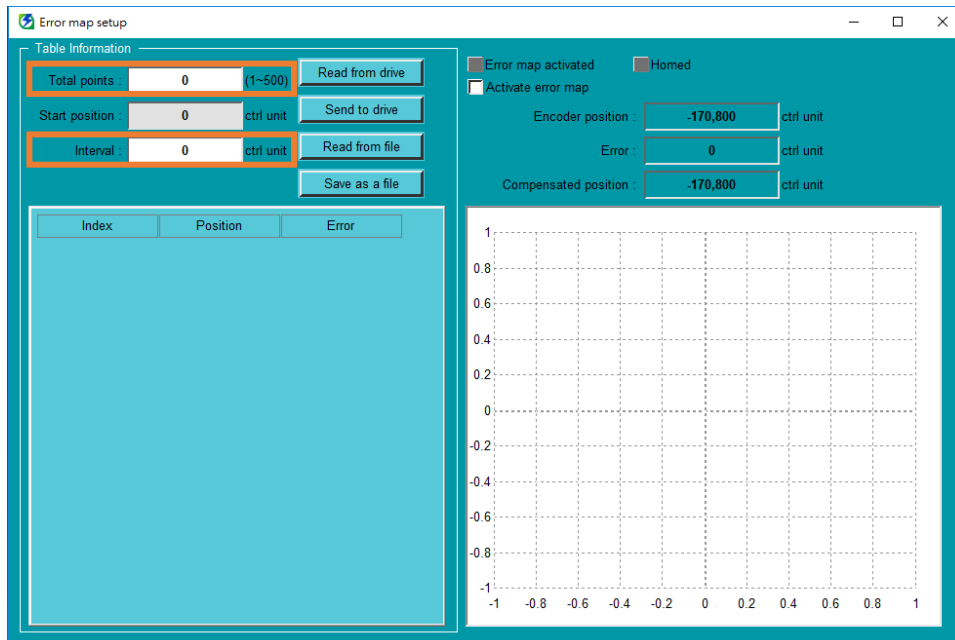

Figure 9.6.2.1.2



Information

- (1) If absolute encoder is used, interval will be automatically allocated based on total points. Therefore, users do not need to key in the value.
- (2) Only AC servo motor and linear motor support the setting of **Start position**.

3. Key in the compensation values in **Error** column.

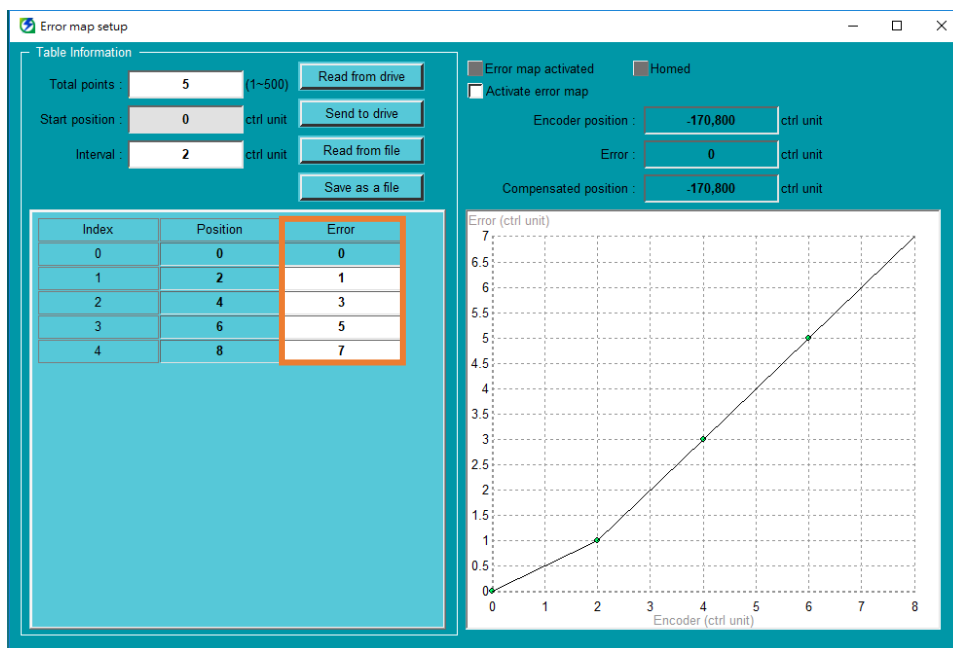

Figure 9.6.2.1.3

4. After users click **Send to drive**, servo drive will be automatically power cycled. After that, users can activate error map.

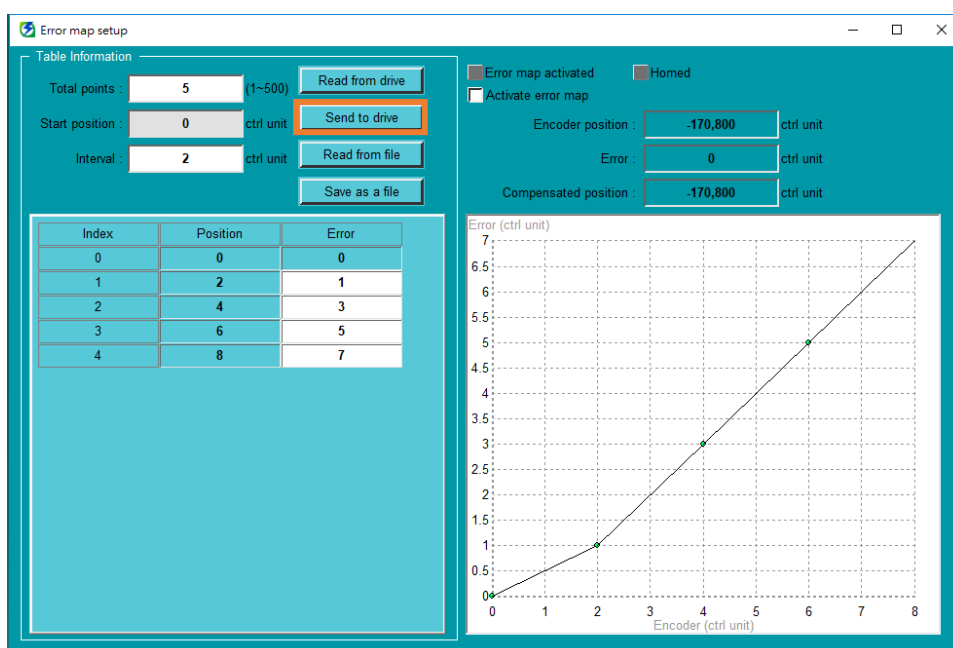

Figure 9.6.2.1.4

9.6.2.2 Load error map

If there has been error map in servo drive's memory, users can click **Read from drive** to load error map from servo drive.

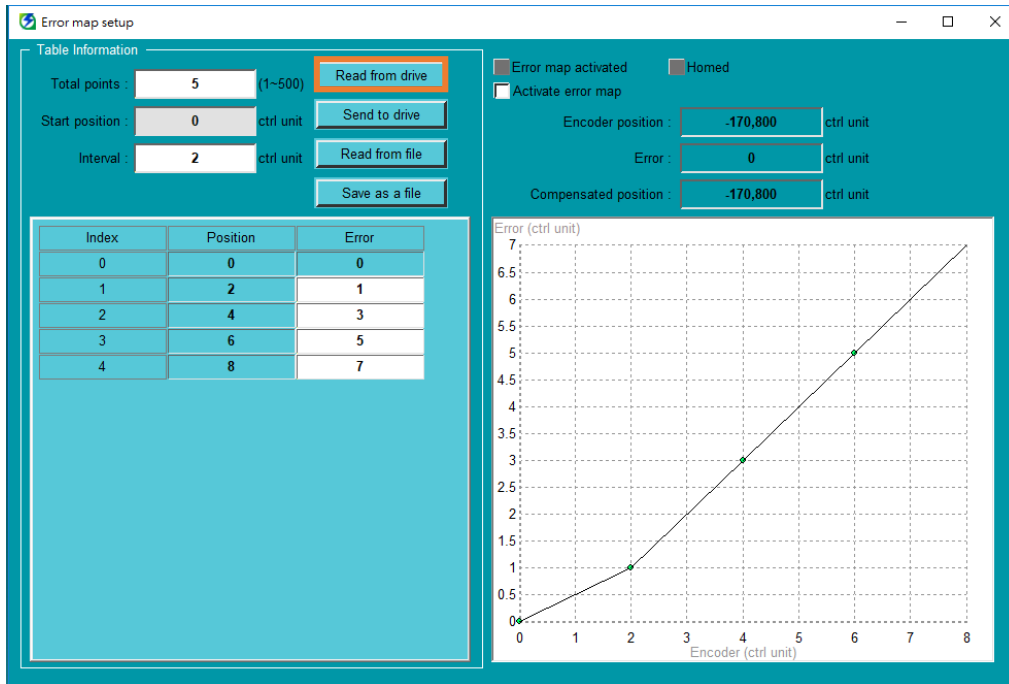

Figure 9.6.2.2.1

9.6.2.3 Save / Read error map

■ Save as a file

1. Click **Save as a file** to save error map file (*.emp) to personal computer.

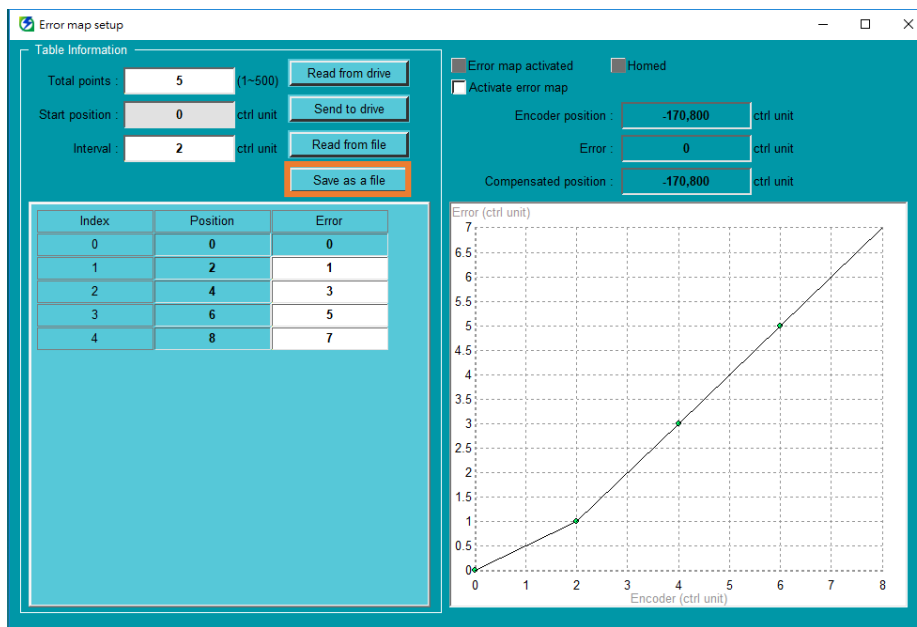

Figure 9.6.2.3.1

2. Key in file name of error map file (*.emp), select archive path, and click **Save**.

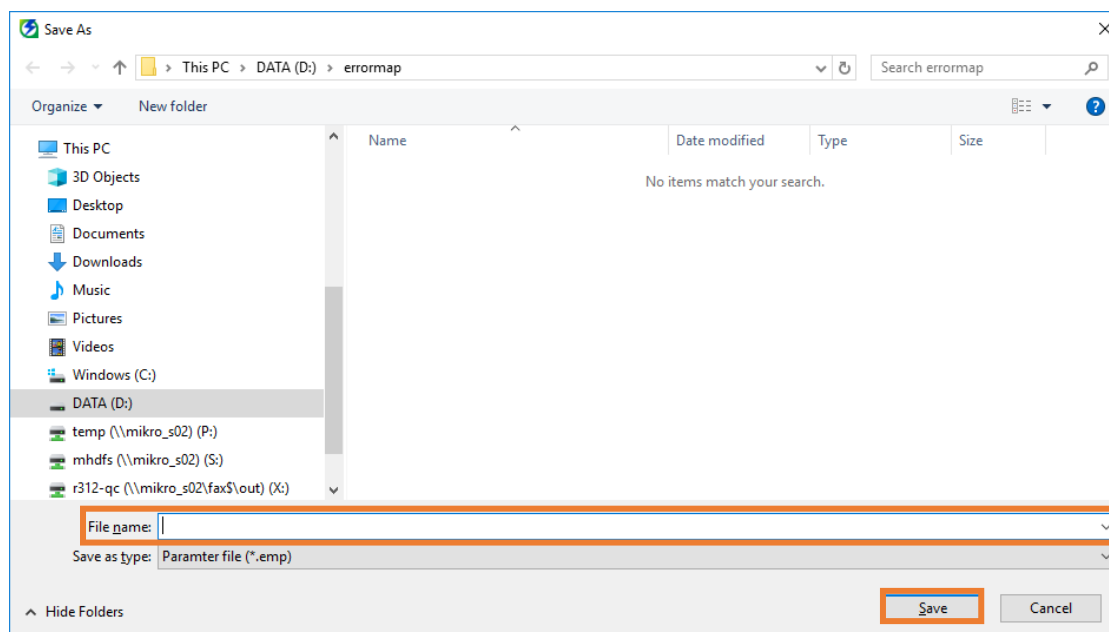

Figure 9.6.2.3.2

■ Read from file

1. Click **Read from file** to read error map file (*.emp) from personal computer.

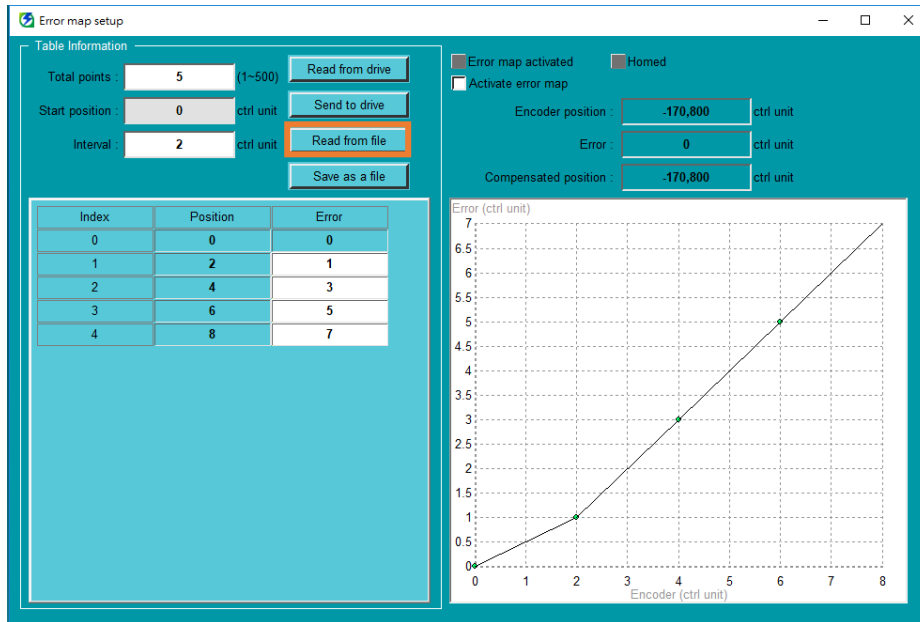

Figure 9.6.2.3.3

2. Select error map file (*.emp), and click **Open**.

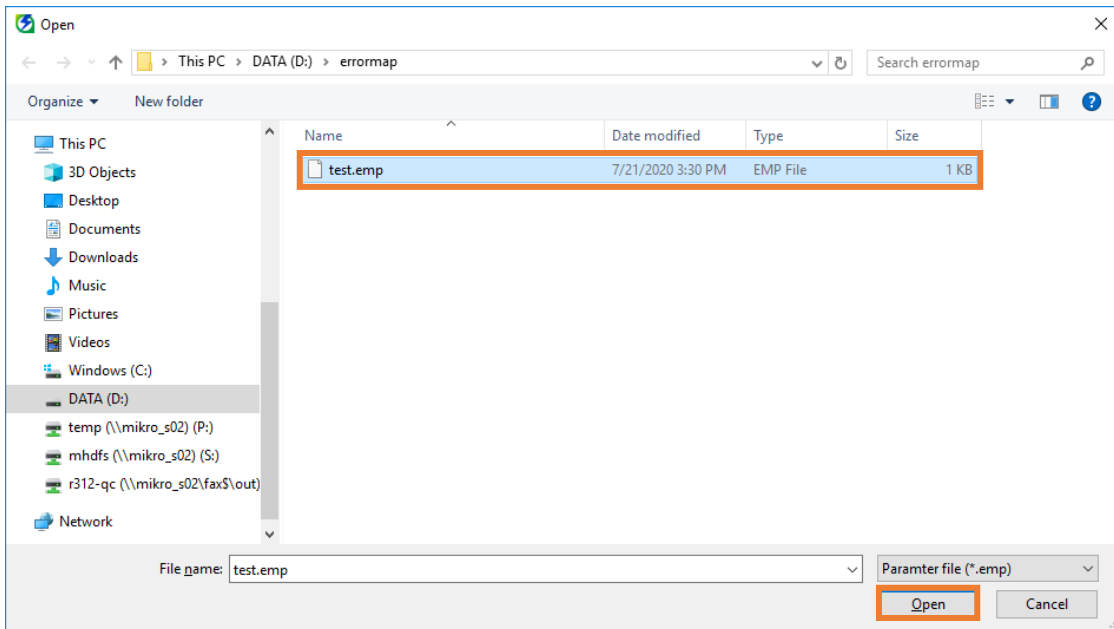

Figure 9.6.2.3.4

9.6.3 Activate error map

Users can activate error map and observe error line chart here.

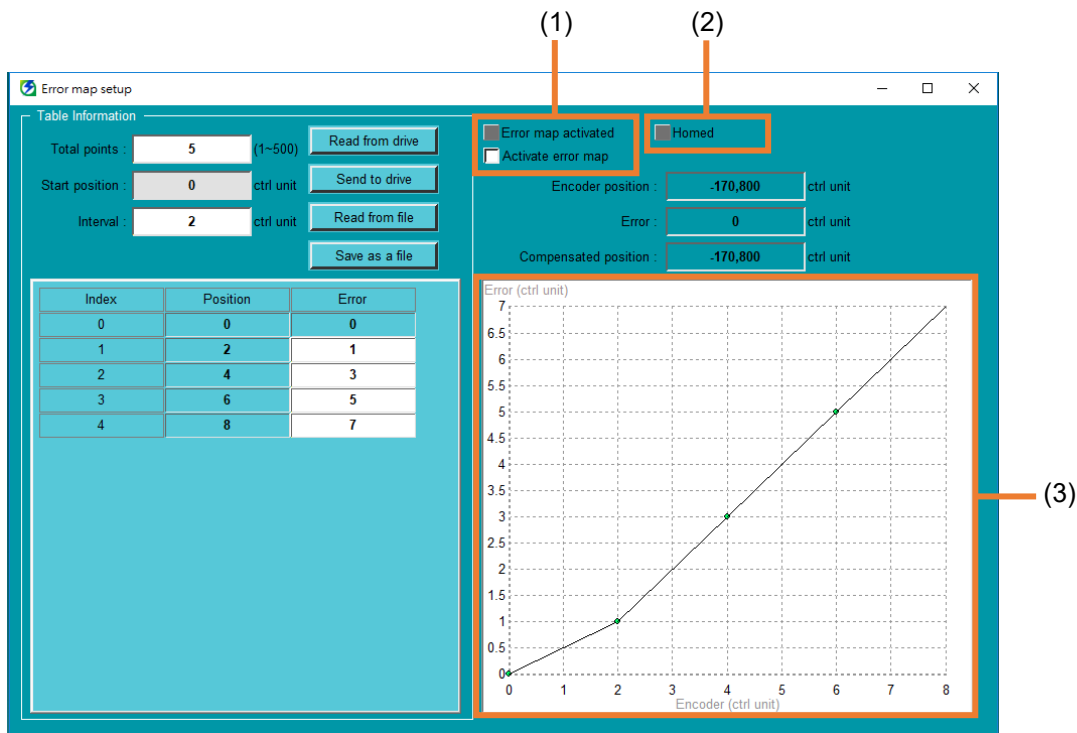

Figure 9.6.3.1

Table 9.6.3.1

No.	Item	Description	
(1)	Error map	Error map activated	No light: Error map is not activated.
			Lights up in green: Error map is activated.
		Activate error map	Unchecked: Do not activate error map.
			Checked: Activate error map.
(2)	Homed	No light: Homing is not completed.	
		Lights up in green: Homing is completed.	
(3)	Error line chart	Users can observe error line chart here.	



Important

- (1) If incremental encoder is used, complete homing first before activating error map.
- (2) To execute homing, deactivate error map first to avoid abnormal actions.
- (3) **Activate error map** cannot be checked or unchecked when the motor is enabled.

9.7 Gantry control system

9.7.1 Brief introduction

High-performance response gantry synchronized control can be achieved by high-speed data exchange technology between two servo drives. The way to activate gantry function via Thunder software is introduced in this section.

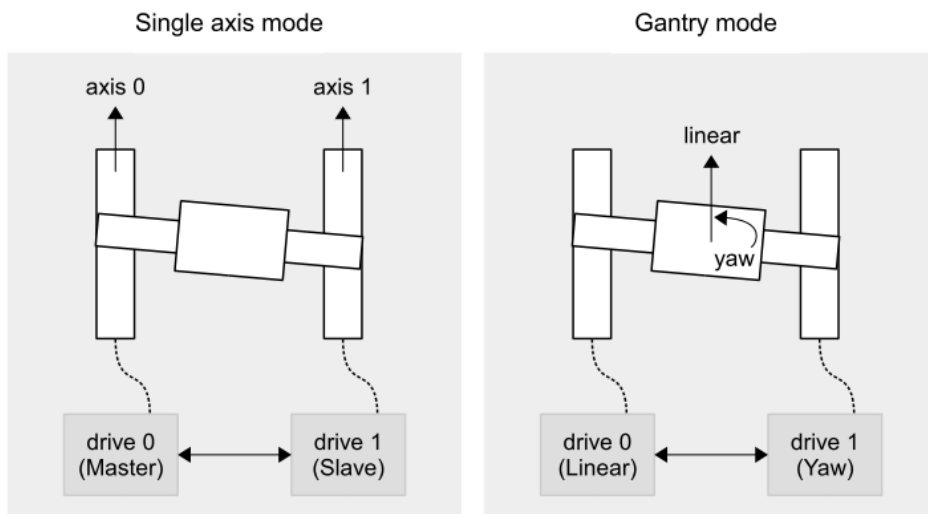

Figure 9.7.1.1



Important

Before gantry function is activated, the two axes are respectively master axis and slave axis. After gantry function is activated, the two axes will respectively become linear axis and yaw axis.

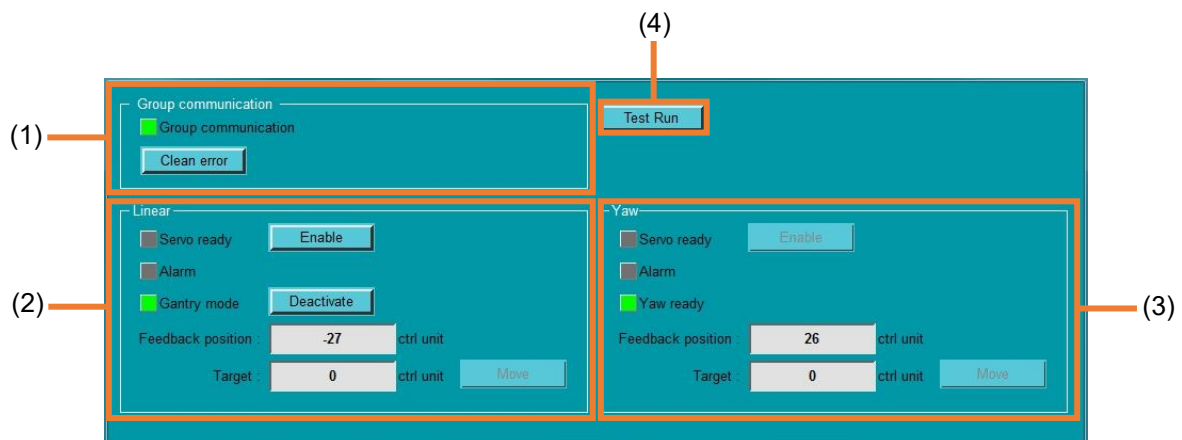



Figure 9.7.1.2

Table 9.7.1.1

No.	Item	Description
(1)	Status field	Besides getting gantry communication status, users can clear gantry-related alarm here if it occurs.
(2)	Status field for linear axis	Users can get linear axis' feedback position and activate/deactivate gantry function here.
(3)	Status field for yaw axis	Users can get yaw axis' feedback position and know whether yaw axis is ready here.
(4)	Test Run	<p>After keying in the target positions in (2) and (3), click Test Run to make the motor move with the velocity set by Pt585 or Pt533.</p> <div style="display: flex; align-items: center;">  <div style="margin-left: 20px;"> <p>Example</p> <ol style="list-style-type: none"> 1. If both master axis and slave axis are linear motors, linear axis' moving velocity is the setting value of Pt585 of master axis, and yaw axis' rotating velocity is the setting value of Pt585 of slave axis. 2. If both master axis and slave axis are AC servo motors, linear axis' moving velocity is the setting value of Pt533 of master axis, and yaw axis' rotating velocity is the setting value of Pt533 of slave axis. </div> </div>

9.7.2 Preparation

1. Select the model supporting gantry function (ED1□-□G-□□□□-□□) and connect two servo drives via CN8 with the communication cable.
2. Initialize the two axes to the level that both of them can be normally operated.



Information

Refer to “E1 Series Servo Drive Gantry Control System User Manual” for the detailed tuning methods and contents.

9.7.3 Gantry setting

Follow the procedure below to complete gantry setting.

1. Click “Open Parameters Setup” icon in the toolbar to open “Parameters Setup” window.

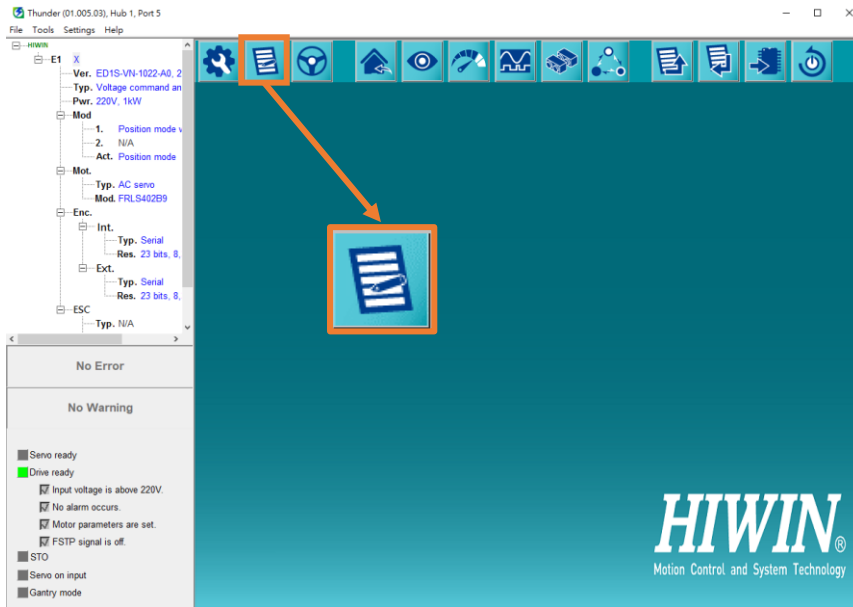

Figure 9.7.3.1

2. Modify Pt00D.□□□X = 2 to Pt00D.□□□X = 1 in master axis, and modify Pt00D.□□□X = 2 to Pt00D.□□□X = 0 in slave axis. After that, save the parameters to Flash and power cycle servo drives.

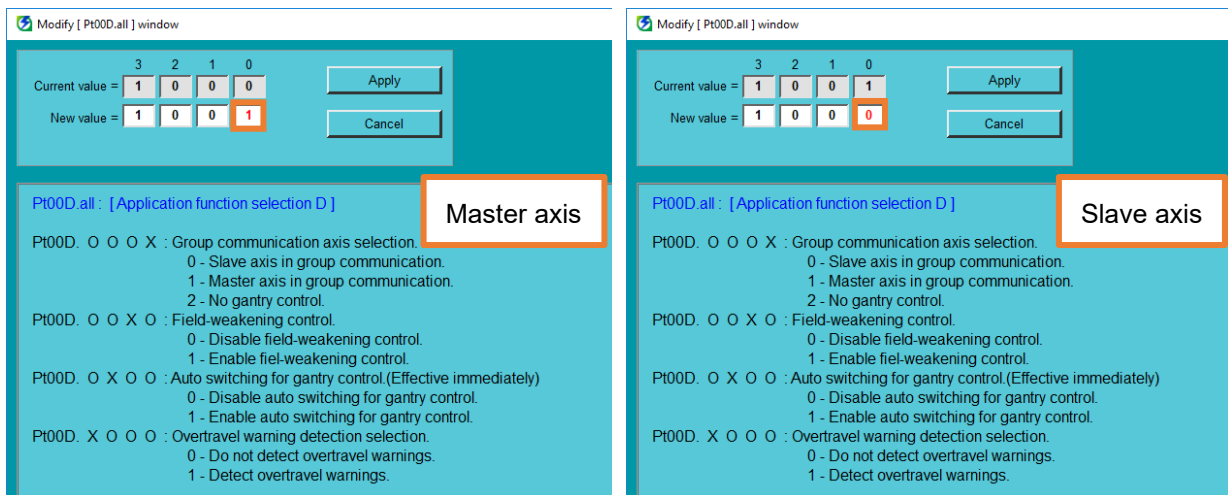

Figure 9.7.3.2

3. Select **Tools** in the menu bar and click **Gantry control system** to open “Gantry control system” window.

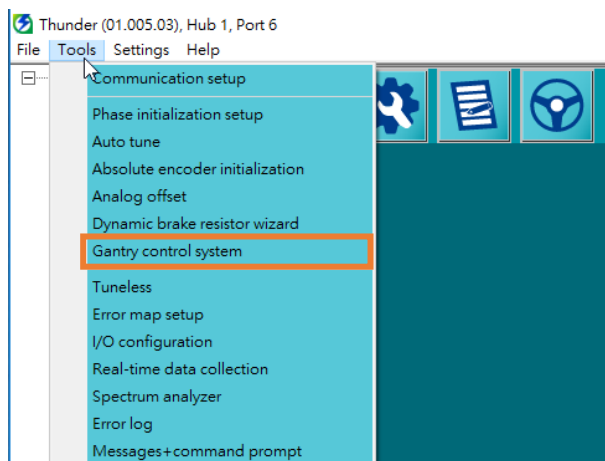

Figure 9.7.3.3

4. Click **Activate** to observe gantry status lights. If they remain green, gantry function is successfully activated.

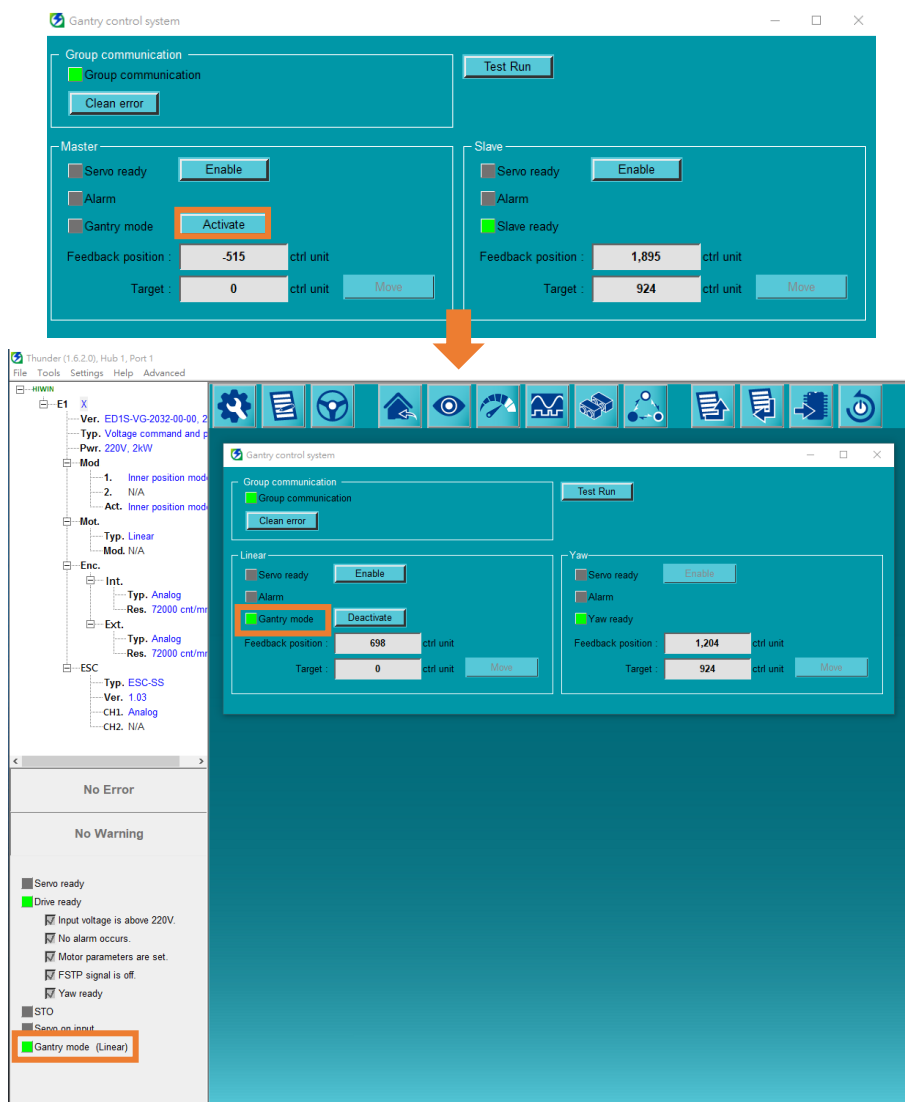

Figure 9.7.3.4

5. Perform test run on gantry mode. After ensuring the motion is normal, open “Parameters Setup” window to modify Pt00D.□X□□ = 0 to Pt00D.□X□□ = 1 in master axis for auto gantry function.

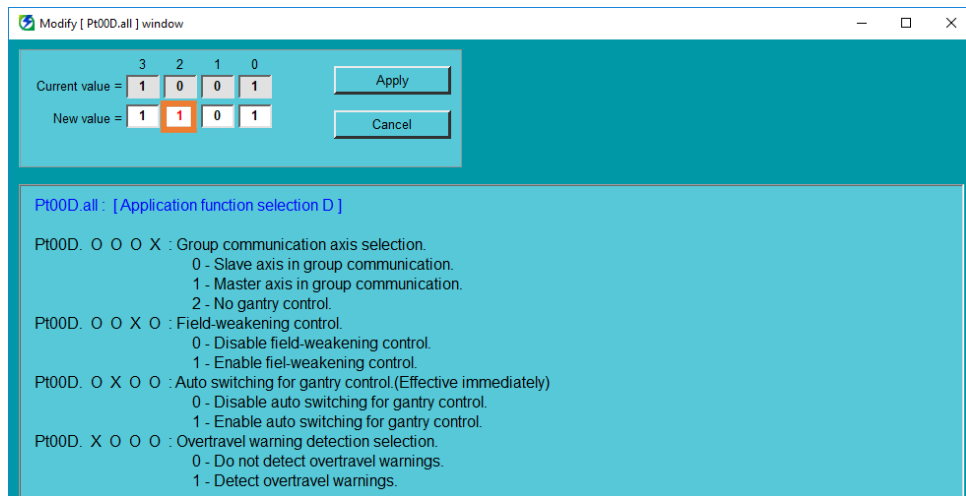

Figure 9.7.3.5

9.8 Dynamic brake resistor wizard

9.8.1 Brief introduction

When the motor operates at high speed with heavy load, the built-in brake resistor may not be able to absorb the kinetic energy in time. Thus longer braking distance is required. Users can follow the procedure below to calculate the suitable resistor.

⚠ CAUTION

- ◆ When main circuit power supply or control circuit power supply is OFF, use dynamic brake to stop the motor. This function cannot be closed via Pt parameters.
- ◆ Pay attention to the contact point current when relay is used. If the current is too large, use magnetic contactor and the contact point of the magnetic contactor must be able to withstand large current.
- ◆ For 1 kW E1 series servo drive or above, dynamic brake resistor (10 Ohm) is already installed inside the servo drive.

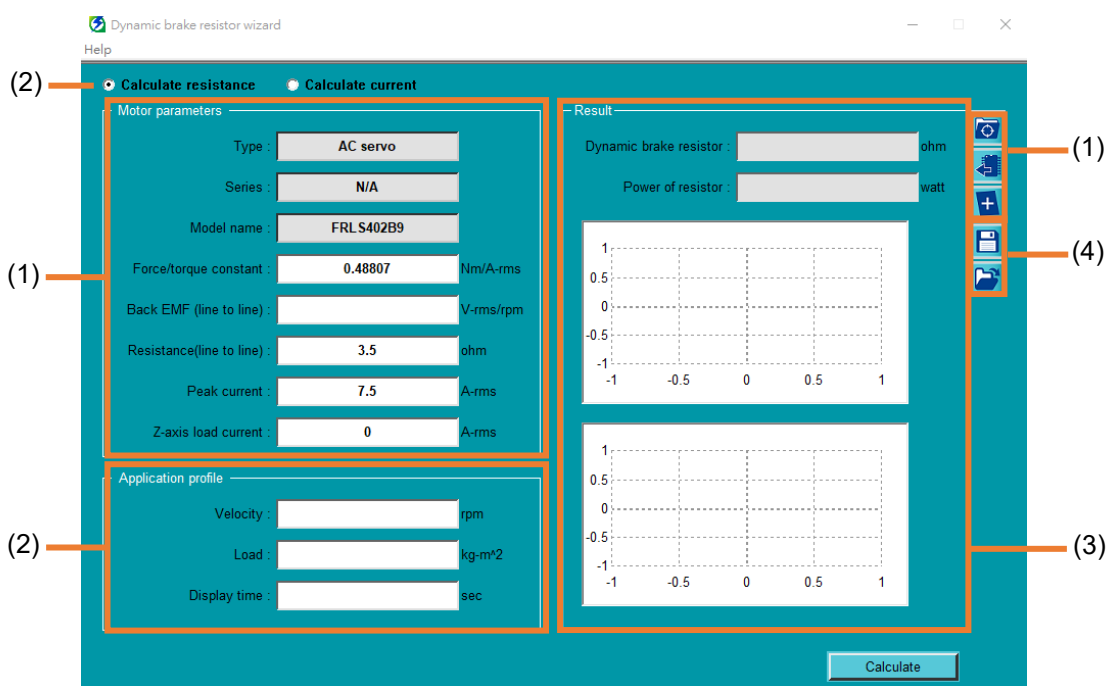

Figure 9.8.1.1

Table 9.8.1.1

No.	Item	Description	Reference
(1)	Motor parameters setting	Connect motor parameters.	section 9.8.2
(2)	Application parameters	Fill in application parameters.	section 9.8.3

	setting		
(3)	Calculation results	Display results and simulated trends.	section 9.8.4
(4)	Save / Load	Save and load parameters.	section 9.8.5

9.8.2 Motor parameters setting

Follow the procedure below to complete motor parameters setting.

1. Select **Tools** in the menu bar and click **Dynamic brake resistor wizard** to open “Dynamic brake resistor wizard” window.

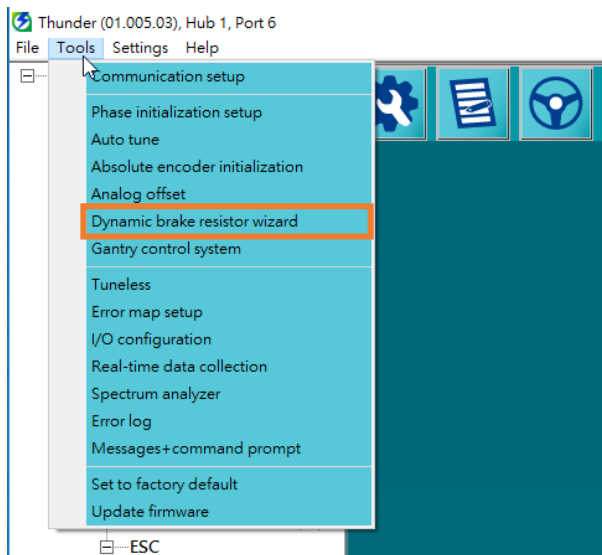

Figure 9.8.2.1

2. Users can select the desired method based on requirement. For example, automatically fill in the connected motor parameters, read motor parameters from servo drive’s memory or define motor parameters on their own.

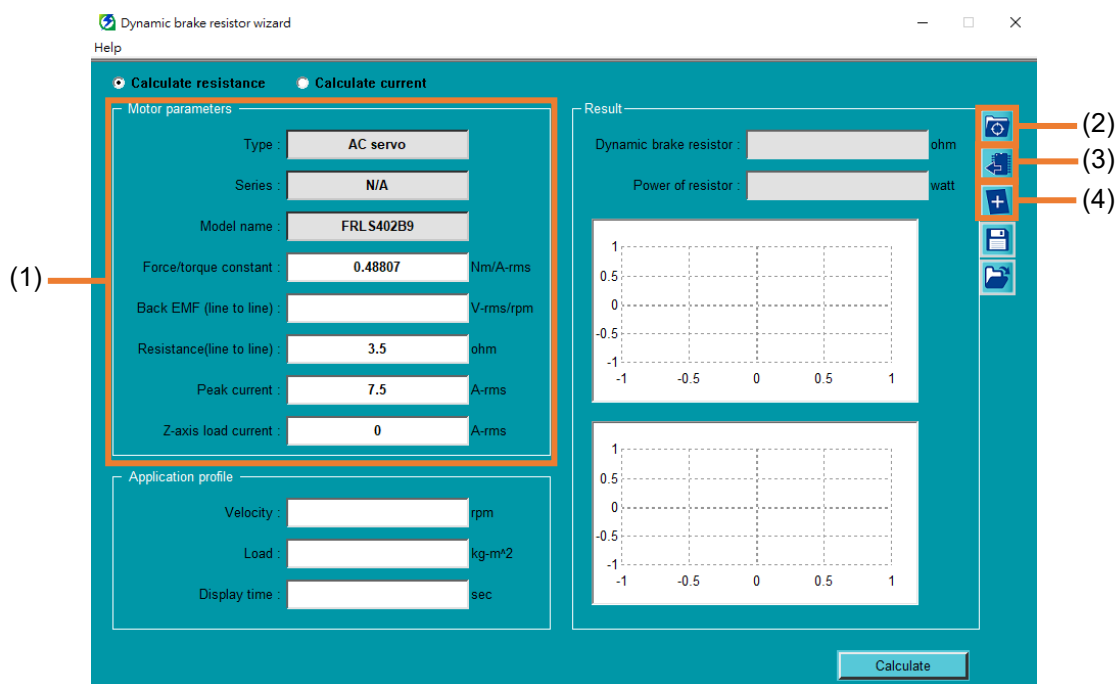

Figure 9.8.2.2

Table 9.8.2.1

No.	Item	Description	Reference
(1)	Motor parameters	After users complete Configuration Wizard, Thunder will automatically fill in motor parameters. Ensure the parameters are correct.	section 9.8.2.1
(2)	HIWIN motor	List all the series and model names of HIWIN motors for users to select. After the selection, Thunder will automatically fill in motor parameters.	section 0
(3)	Read parameters	Read motor parameters from servo drive's memory.	section 9.8.2.3
(4)	Other brand motor	Users can define the connected motor parameters on their own.	section 9.8.2.4

9.8.2.1 Motor parameters

After users complete Configuration Wizard, Thunder will automatically fill in motor parameters. Ensure the parameters are correct.

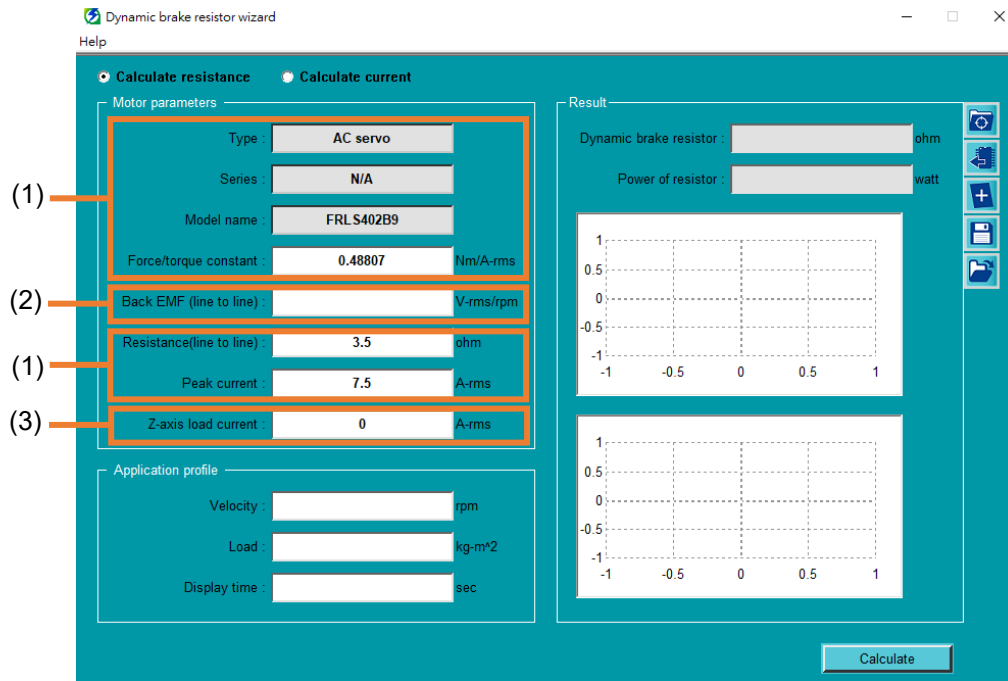



Figure 9.8.2.1.1

Table 9.8.2.1.1

No.	Item	Description
(1)	Motor parameters	Parameters that will be automatically filled in by Thunder. <ul style="list-style-type: none"> ◆ Type ◆ Series ◆ Model name ◆ Force / torque constant ◆ Resistance (line to line) ◆ Peak current
(2)	Back EMF (line to line)	Fill in the corresponding motor back EMF, which can be found from the catalog.
(3)	Z-axis load current	For the application of Z axis, fill in the current that the motor is enabled and remains static.

9.8.2.2 HIWIN motor

If it is a HIWIN motor, after clicking , users can select “Type”, “Series” and “Model name” via drop-down menu. After the selection, Thunder will automatically fill in “Force / torque constant”, “Resistance (line to line)” and “Peak current”.

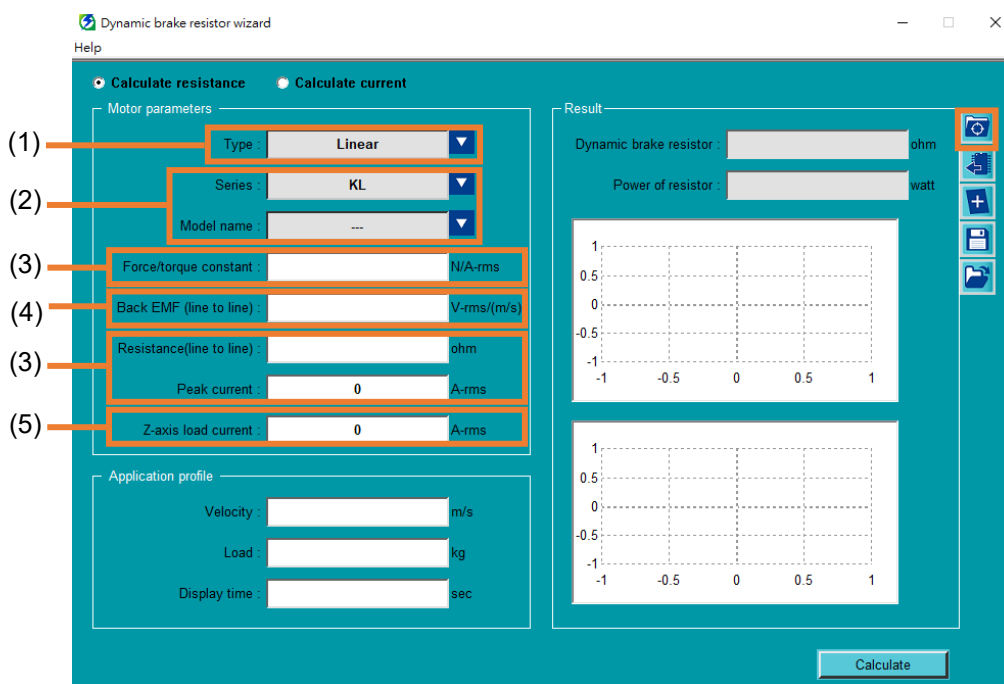

Figure 9.8.2.2.1

Table 9.8.2.2.1

No.	Item	Description
(1)	Motor type	Select the connected motor type via drop-down menu. <ul style="list-style-type: none"> ◆ Linear ◆ Torque / direct drive ◆ AC servo
(2)	Motor series and model name	Select the connected motor series and model name via drop-down menu.
(3)	Motor parameters	Parameters that will be automatically filled in by Thunder. <ul style="list-style-type: none"> ◆ Force / torque constant ◆ Resistance (line to line) ◆ Peak current
(4)	Back EMF (line to line)	Fill in the corresponding motor back EMF, which can be found from the catalog.
(5)	Z-axis load current	For the application of Z axis, fill in the current that the motor is enabled and remains static.

9.8.2.3 Read parameters

Click  to read motor parameters from servo drive's memory.

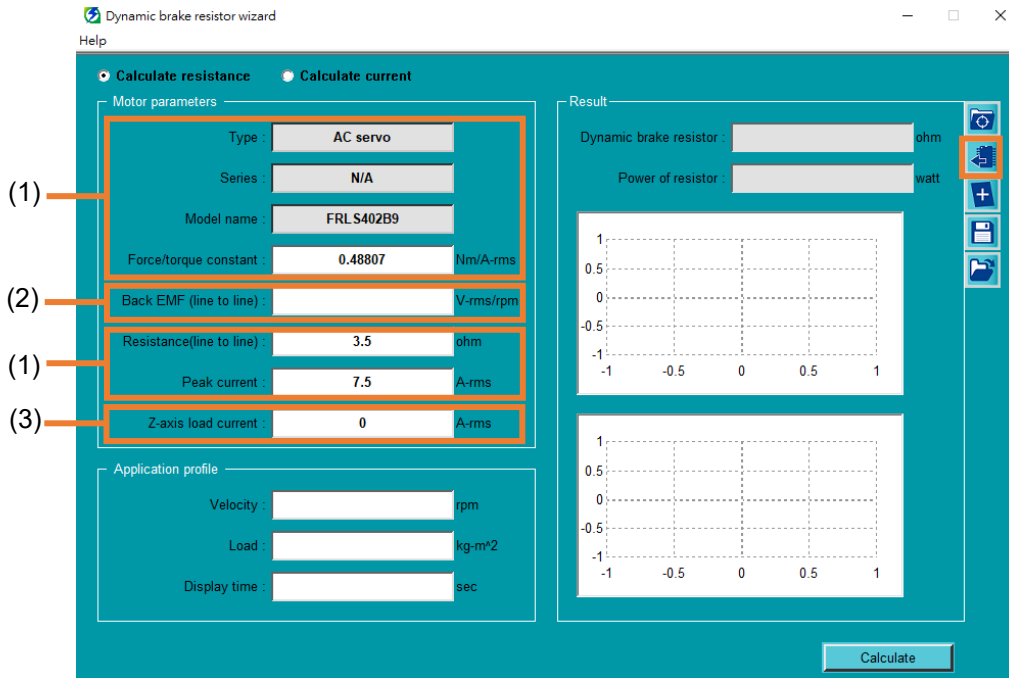



Figure 9.8.2.3.1

Table 9.8.2.3.1

No.	Item	Description
(1)	Motor parameters	Parameters that will be automatically filled in by Thunder. <ul style="list-style-type: none"> ◆ Type ◆ Series ◆ Model name ◆ Force / torque constant ◆ Resistance (line to line) ◆ Peak current
(2)	Back EMF (line to line)	Fill in the corresponding motor back EMF, which can be found from the catalog.
(3)	Z-axis load current	For the application of Z axis, fill in the current that the motor is enabled and remains static.

9.8.2.4 Other brand motor

If it is an other brand motor, after clicking , users must select “Type” and fill in “Model name”, “Force / torque constant”, “Resistance (line to line)” and “Peak current”.

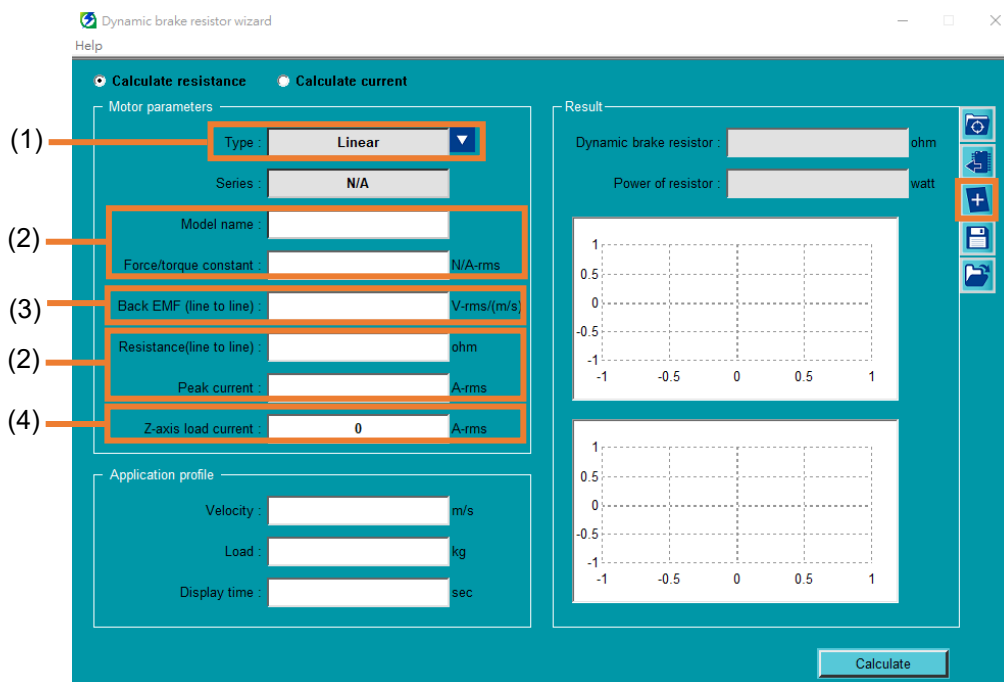

Figure 9.8.2.4.1

Table 9.8.2.4.1

No.	Item	Description
(1)	Motor type	Select the connected motor type via drop-down menu. <ul style="list-style-type: none"> ◆ Linear ◆ Torque / direct drive ◆ AC servo
(2)	Motor parameters	Fill in “Model name”, “Force / torque constant”, “Resistance (line to line)” and “Peak current” based on the configuration.
(3)	Back EMF (line to line)	Fill in the corresponding motor back EMF, which can be found from the catalog.
(4)	Z-axis load current	For the application of Z axis, fill in the current that the motor is enabled and remains static.

9.8.3 Application parameters setting

Fill in application parameters based on system brake performance requirement to evaluate the proper resistance for dynamic brake. There are two kinds of calculation, calculate resistance and calculate current.

◆ Calculate resistance

Fill in application parameters based on performance requirement to get the minimum resistance of dynamic brake.

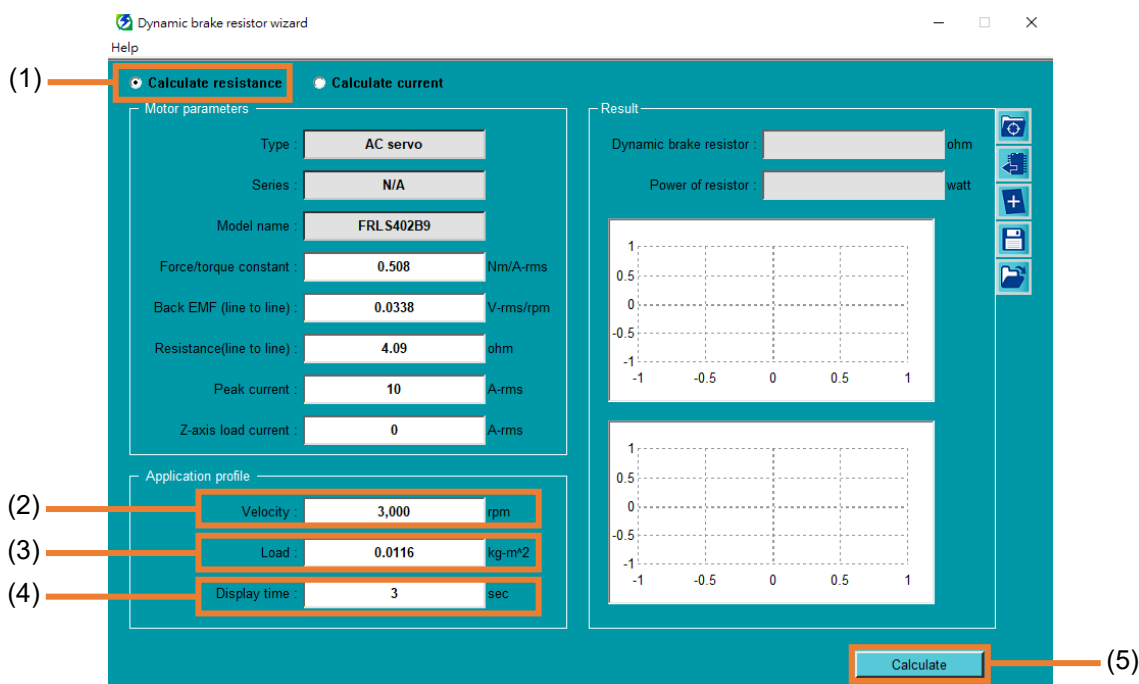

Figure 9.8.3.1

Table 9.8.3.1

No.	Item	Description
(1)	Calculate resistance	Select Calculate resistance .
(2)	Velocity	Fill in the maximum moving velocity of the system based on actual situation.
(3)	Load	Fill in the load of the system based on actual situation.
(4)	Display time	It is display time for the simulated trends on the right side. Users can fill in the time to be observed.
(5)	Calculate	After parameters setting is done, click Calculate to get the resistance to be used.



Important

If the simulated trends from deceleration to stop cannot be fully displayed, users must increase the value of “Display time” and click **Calculate** again.

◆ Calculate current

Fill in application parameters and the resistance of dynamic brake to be calculated based on performance requirement to check if the resistance is suitable.

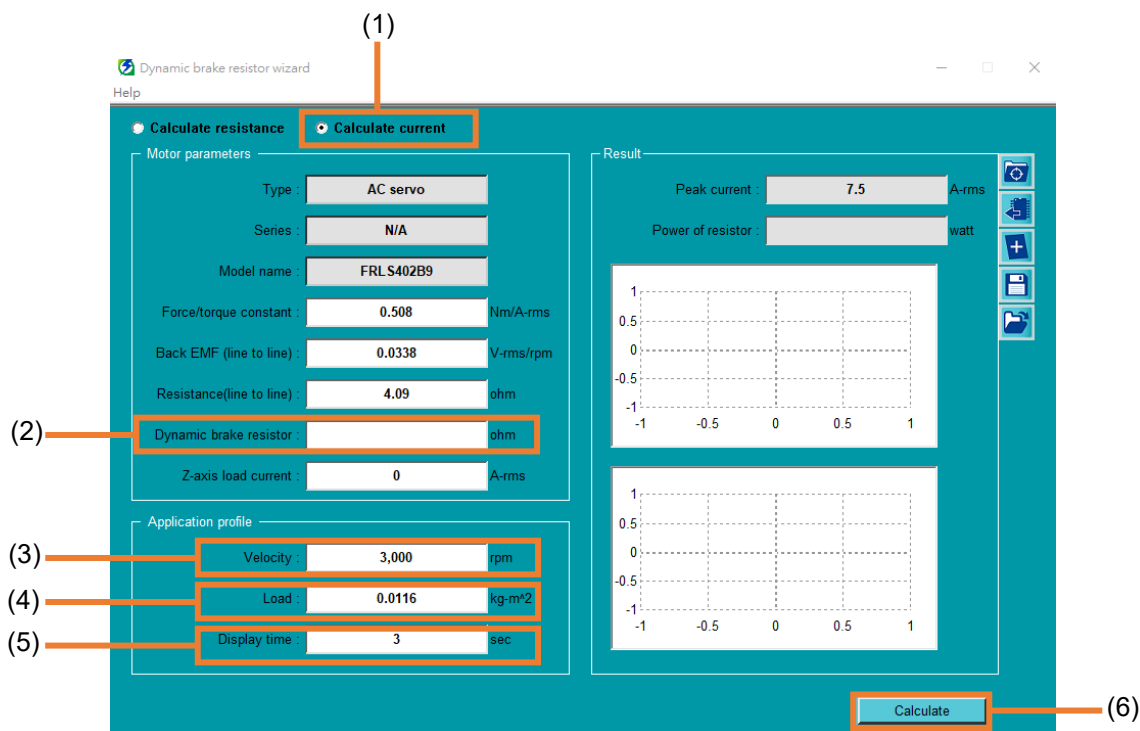

Figure 9.8.3.2

Table 9.8.3.2

No.	Item	Description
(1)	Calculate current	Select Calculate current .
(2)	Resistance of dynamic brake	Fill in the resistance of dynamic brake to be calculated.
(3)	Velocity	Fill in the maximum moving velocity of the system based on actual situation.
(4)	Load	Fill in the load of the system based on actual situation.
(5)	Display time	It is display time for the simulated trends on the right side. Users can fill in the time to be observed.
(6)	Calculate	After parameters setting is done, click Calculate to get the peak current.



Important

If the simulated trends from deceleration to stop cannot be fully displayed, users must increase the value of “Display time” and click **Calculate** again.

9.8.4 Calculation results

Based on section 9.8.3, there are two kinds of calculation results.

◆ Calculate resistance

“Dynamic brake resistor information” window will pop up to inform users whether to use dynamic brake resistor or not.

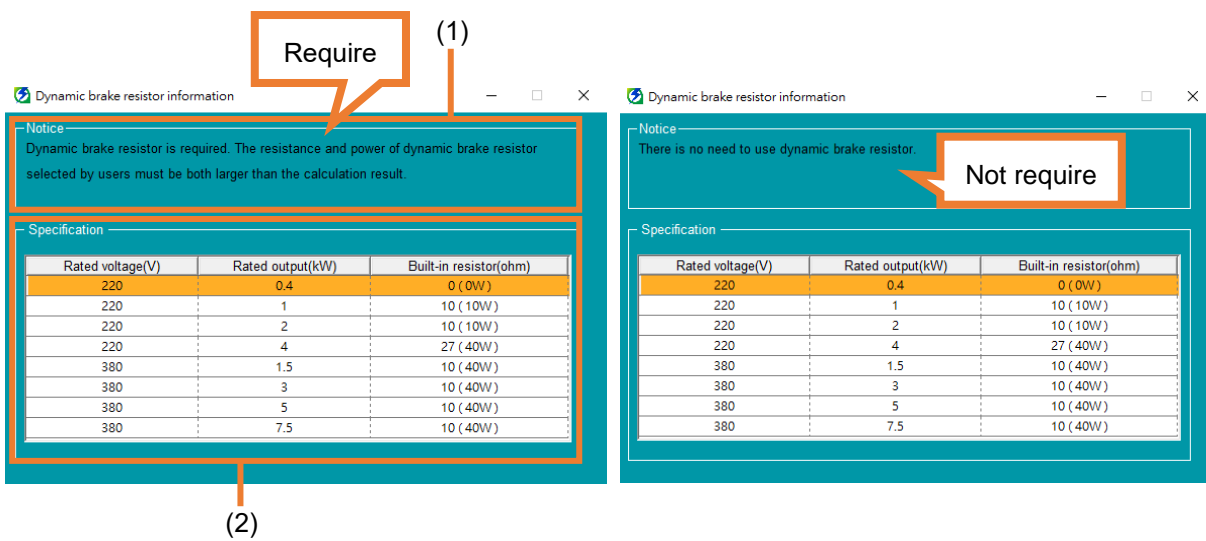

Figure 9.8.4.1

Table 9.8.4.1

No.	Item	Description
(1)	Whether to use dynamic brake resistor or not	Inform users whether to use dynamic brake resistor or not.
(2)	Specification of built-in resistor	Inform users the built-in resistor of different wattage of servo drive.

Go back to “Dynamic brake resistor wizard” window, get the resistance to be used or observe the trends of deceleration.

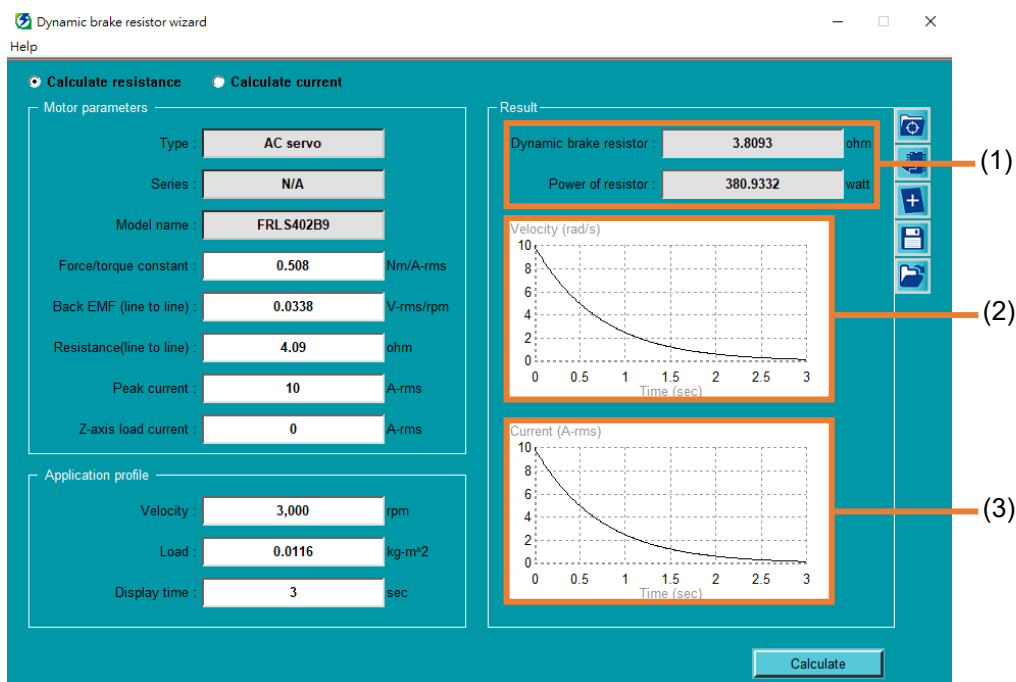

Figure 9.8.4.2

Table 9.8.4.2

No.	Item	Description
(1)	Resistance information	Resistance to be used and power.
(2)	Velocity trend	This graph simulates the falling trend of the velocity during deceleration. By observing the trend, users can check if it meets the expected performance.
(3)	Current trend	This graph simulates the falling trend of the current during deceleration.



Important

- (1) For proper braking performance, the smaller the resistance is, the larger the power should be.
- (2) When external dynamic brake resistor is required, use aluminum housed power resistor. The installation site must be with well ventilation and heat dissipation to avoid overheating.

◆ Calculate current

“Dynamic brake resistor information” window will pop up to inform users whether the resistance is suitable.

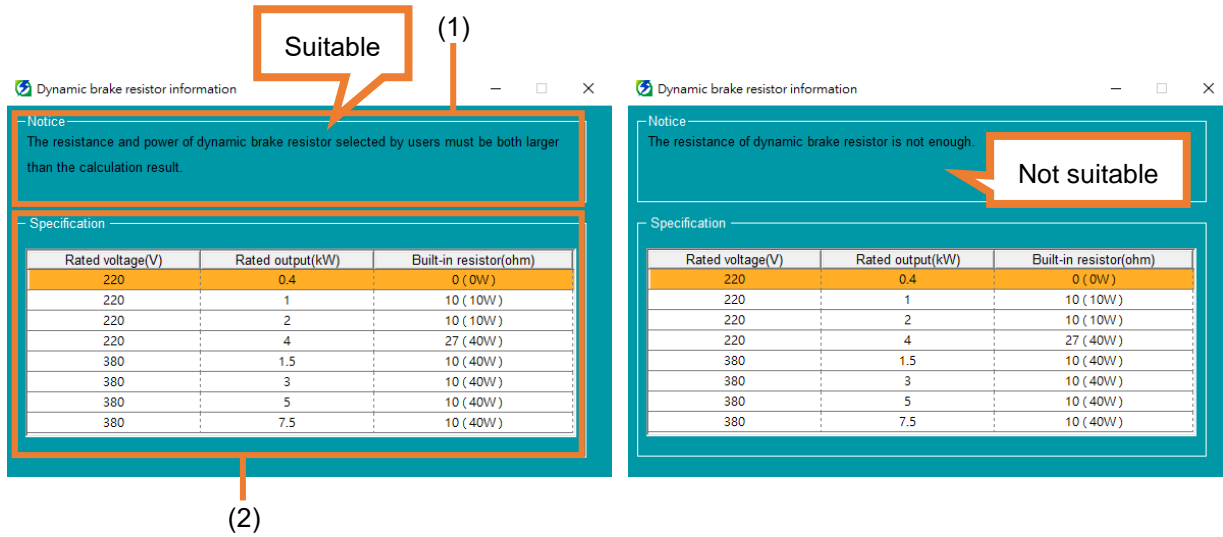

Figure 9.8.4.3

Table 9.8.4.3

No.	Item	Description
(1)	Evaluation of resistance of dynamic brake	Inform users whether the resistance is enough.
(2)	Specification of built-in resistor	Inform users the built-in resistor of different wattage of servo drive.

Go back to “Dynamic brake resistor wizard” window, ensure the resistance to be used will not make the peak current too high or observe the trends of deceleration.

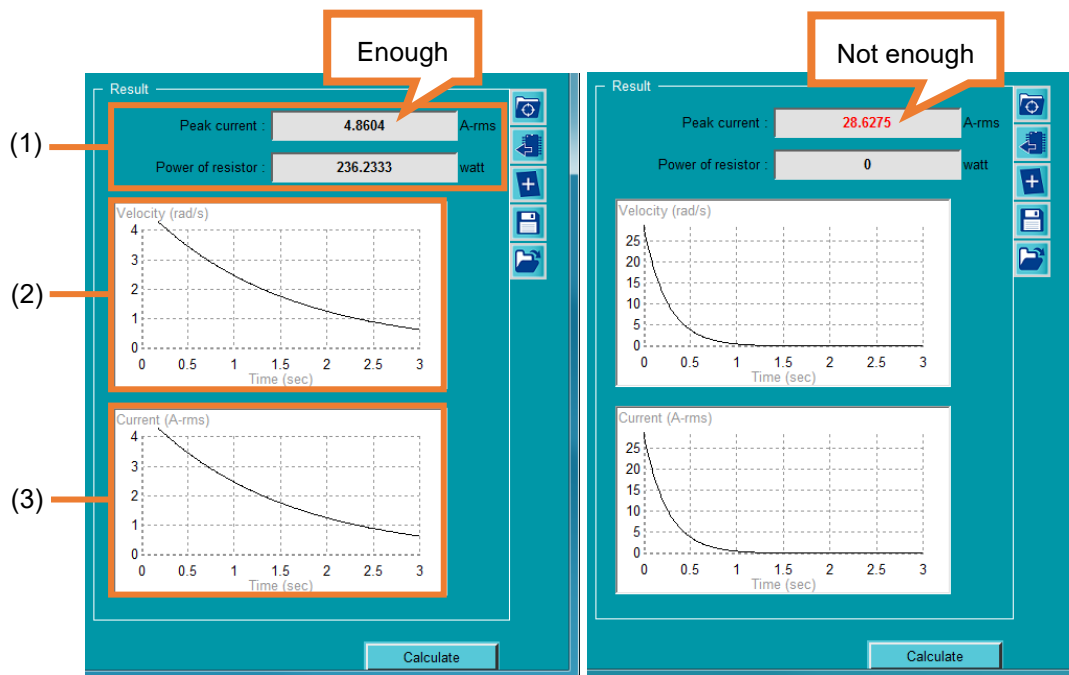

Figure 9.8.4.4

Table 9.8.4.4

No.	Item	Description
(1)	Current information	Check if the resistance to be used is enough. If it is not enough, the peak current will be displayed in red words.
(2)	Velocity trend	This graph simulates the falling trend of the velocity during deceleration. By observing the trend, users can check if it meets the expected performance.
(3)	Current trend	This graph simulates the falling trend of the current during deceleration.



Important

- (1) For proper braking performance, the smaller the resistance is, the larger the power should be.
- (2) When external dynamic brake resistor is required, use aluminum housed power resistor. The installation site must be with well ventilation and heat dissipation to avoid overheating.

9.8.5 Save / Load

■ Save as a file

3. Click  to save motor parameters file (*.mot) to personal computer.

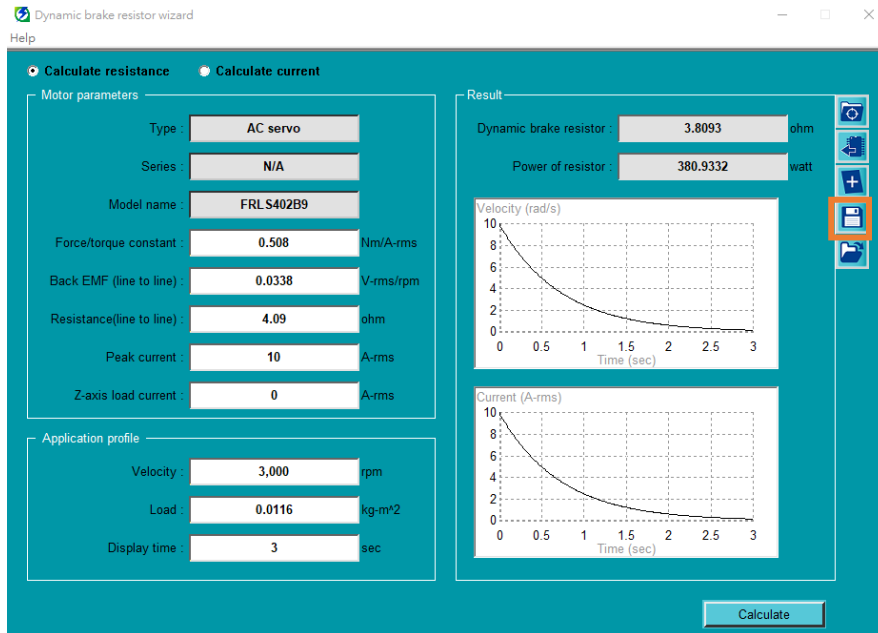

Figure 9.8.5.1

4. Key in file name of motor parameters file (*.mot), select archive path, and click **Save**.

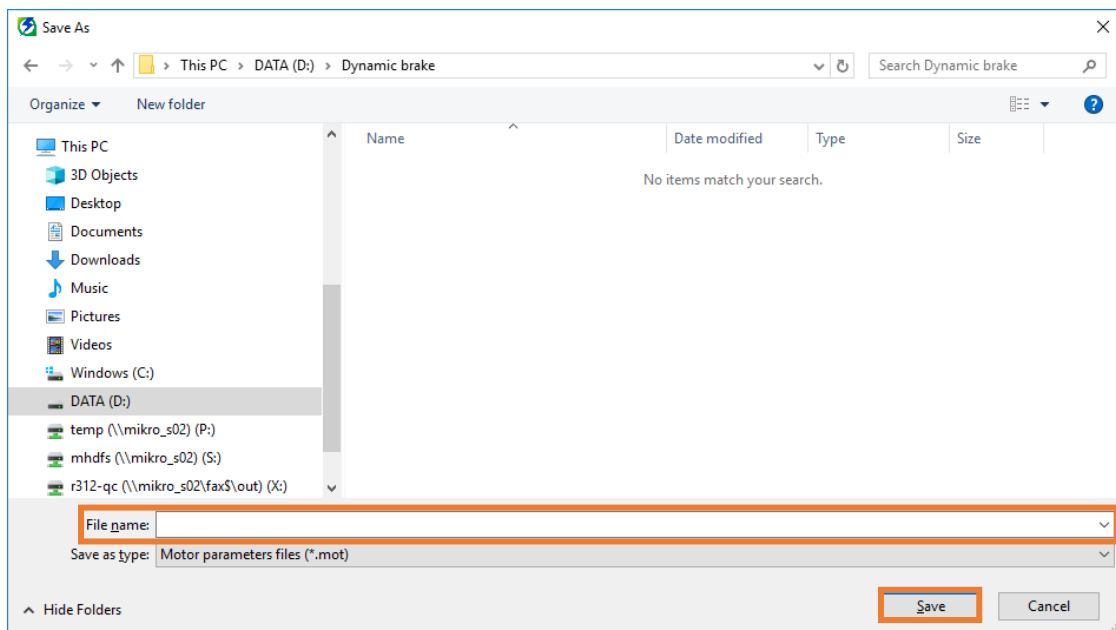

Figure 9.8.5.2

■ Load from file

3. Click  to load motor parameters file (*.mot) from personal computer.

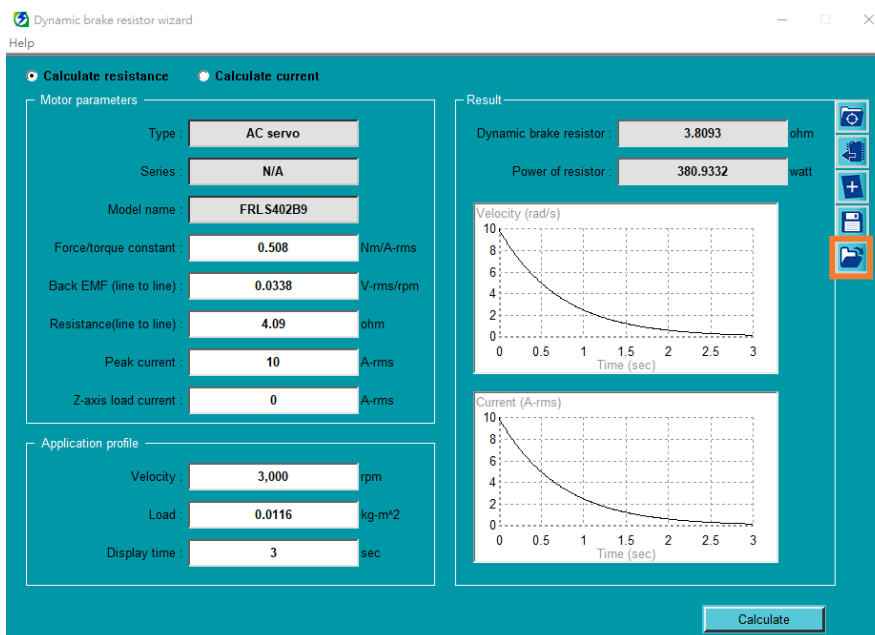

Figure 9.8.5.3

4. Select motor parameters file (*.mot), and click **Open**.

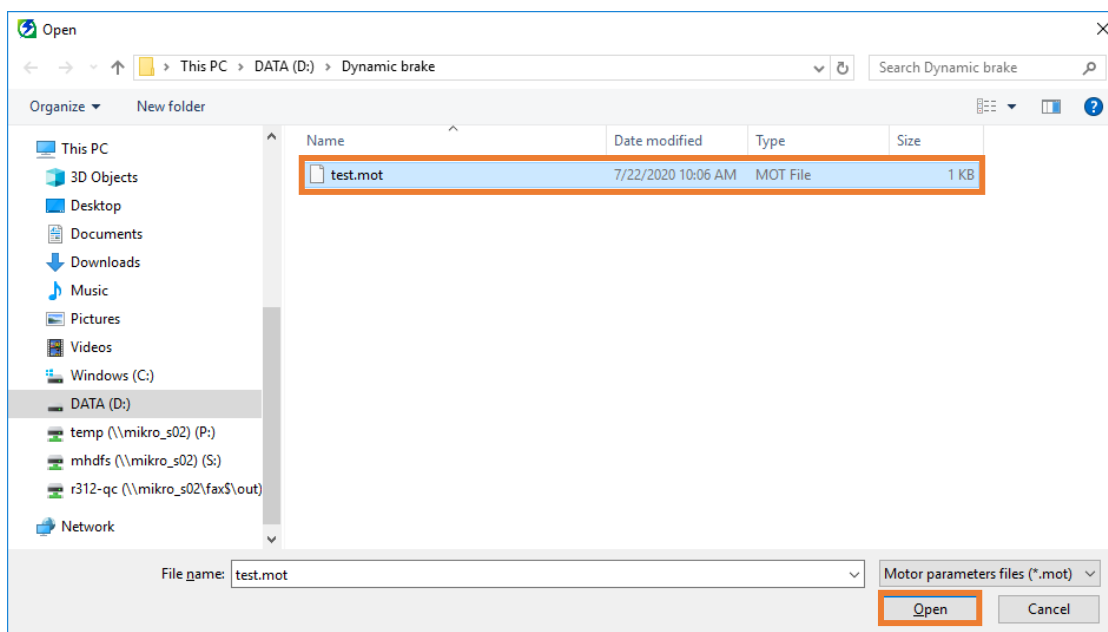

Figure 9.8.5.4

(This page is intentionally left blank.)

10. Basic Settings of Thunder Interface

10.	Basic Settings of Thunder Interface	10-1
10.1	Brief introduction	10-2
10.2	Display unit switching	10-2
10.2.1	Brief introduction	10-2
10.2.2	Unit options	10-3
10.2.3	Display unit setting	10-4
10.2.3.1	User-defined	10-5
10.2.3.2	Auto set.....	10-6
10.2.3.3	Where to apply.....	10-8
10.3	Language switching	10-11
10.3.1	Brief introduction	10-11
10.3.2	Language switching setting.....	10-11
10.4	Help.....	10-12
10.4.1	Brief introduction	10-12
10.4.2	Help setting	10-12

10.1 Brief introduction

The basic settings of Thunder interface are introduced in this chapter. With the following functions, users can change language, perform unit conversion, etc.

10.2 Display unit switching

10.2.1 Brief introduction

Display unit is an aid for interface unit switching. It converts the basic unit defined by servo drive (ctrl unit) to the physical unit that users are more familiar with or easy to identify. During the converting process, differences in accuracy will occur due to numerical calculations.

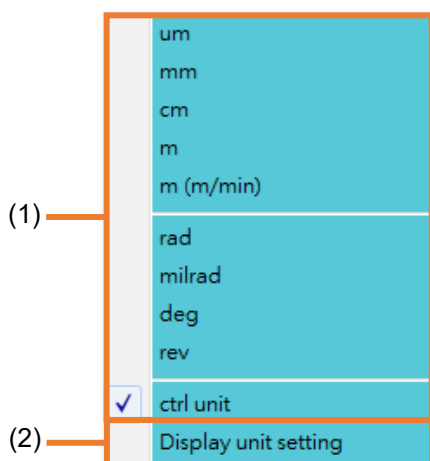

Figure 10.2.1.1

Table 10.2.1.1

No.	Item	Description	Reference
(1)	Display unit selection	Select the available display unit.	section 10.2.2
(2)	Display unit setting	Set the proportion of display unit conversion.	section 10.2.3

10.2.2 Unit options

Display unit can be classified into three categories, linear unit, rotary unit and control unit. Control unit is the basic unit defined by servo drive; linear unit and rotary unit are the derivative units generated by control unit. For these two units, users must set the proportion of display unit conversion (refer to section 10.2.3) in advance for selection. Display unit will simultaneously convert two physical quantities, position and velocity. Refer to Table 10.2.2.2 for the converting names.

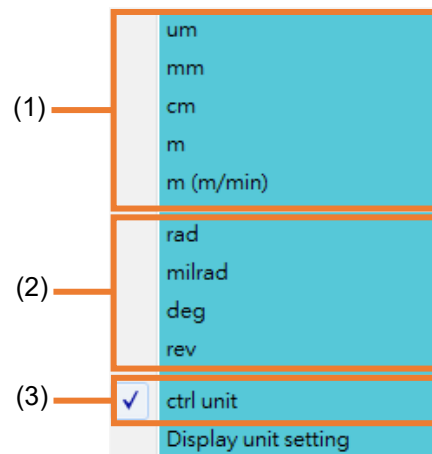

Figure 10.2.2.1

Table 10.2.2.1

No.	Item	Description	Reference
(1)	Linear unit	Available options for linear unit.	--
(2)	Rotary unit	Available options for rotary unit.	--
(3)	Control unit	The basic unit of servo drive commands; it is defined by Pt20E and Pt210.	section 4.3.6.3

Table 10.2.2.2

Unit type	Position unit	Velocity unit
Linear unit	um	um/s
	mm	mm/s
	cm	cm/s
	m	m/s
	m (m/min)	m/min
Rotary unit	rad	rad/s
	milrad	milrad/s
	deg	deg/s
	rev	rps
Control unit	ctrl unit	mm/s
		rpm

10.2.3 Display unit setting

There are two ways to set the proportion of display unit conversion: **User-defined** or **Auto set**

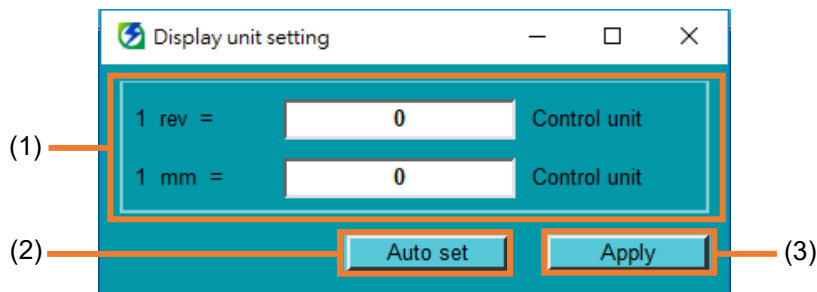

Figure 10.2.3.1

Table 10.2.3.1

No.	Item	Description
(1)	Setting for the proportion of conversion	Users can set the proportion of display unit conversion. The first line is for rotary unit; the second line is for linear unit.
(2)	Auto set	The proportion of display unit conversion will be automatically set based on Electronic gear ratio setting .
(3)	Activate setting	Activate the proportion of display unit conversion.



Information

- (1) If the proportion of conversion is 0, the corresponding unit options (Figure 10.2.2.1) cannot be selected.
- (2) After clicking **Apply**, perform **Send to drive** to avoid losing the settings after servo drive is reset.

10.2.3.1 User-defined

Users can define the proportion of display unit conversion.

1. Select **Settings** in the menu bar, click **Display unit** and click **Display unit setting** to open “Display unit setting” window.

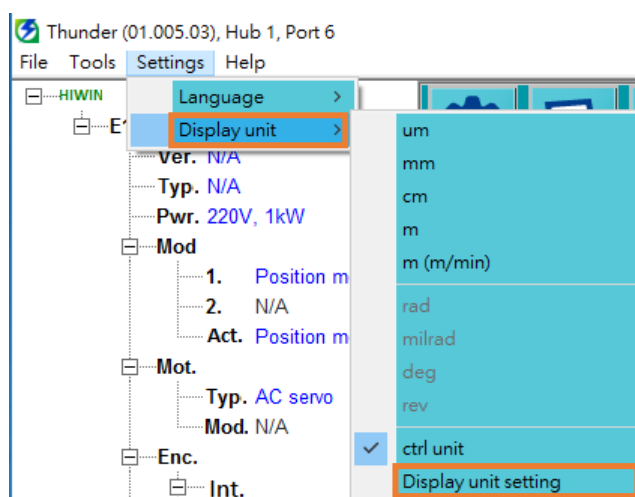

Figure 10.2.3.1.1

2. Set the proportion of display unit conversion, and click **Apply**.

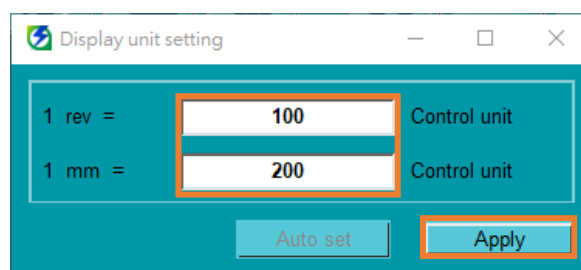

Figure 10.2.3.1.2

10.2.3.2 Auto set

In **Electronic gear ratio setting**, if control unit is not 0, Thunder will automatically calculate the proportion of display unit conversion and **Auto set** button can be clicked (as Figure 10.2.3.2.1 shows). If control unit is 0, **Auto set** button cannot be clicked (as Figure 10.2.3.2.2 shows).

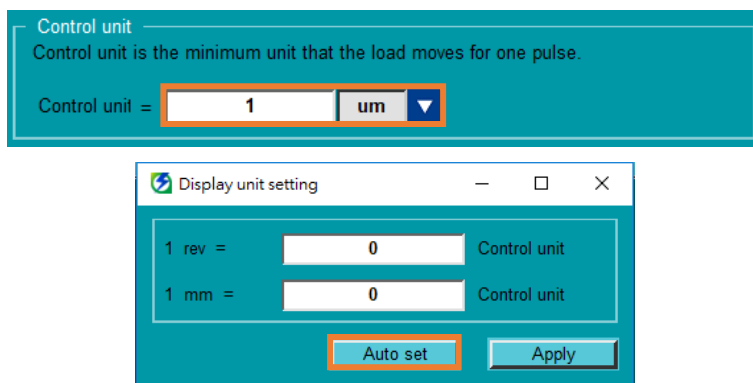

Figure 10.2.3.2.1

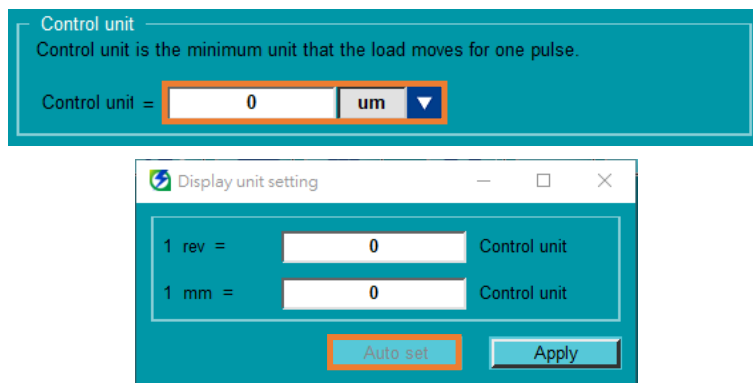

Figure 10.2.3.2.2

1. Select **Settings** in the menu bar, click **Display unit** and click **Display unit setting** to open "Display unit setting" window.

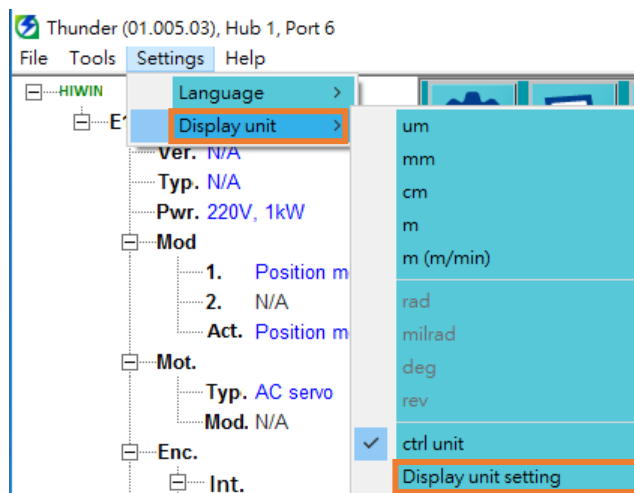

Figure 10.2.3.2.3

2. Click **Auto set**. The calculated proportion of display unit conversion will be automatically filled in.

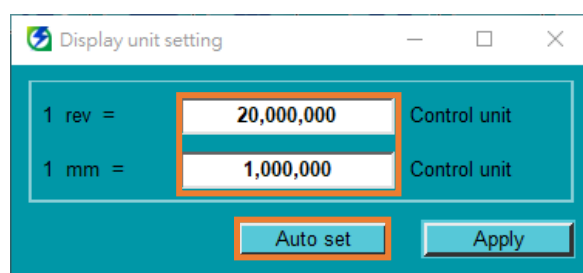

Figure 10.2.3.2.4



Information

The mechanical option in electronic gear ratio will simultaneously set rotary unit and linear unit. However, there are two exceptions: “Linear motor” only sets linear unit; “Other” only sets rotary unit.

3. Click **Apply** to activate setting.

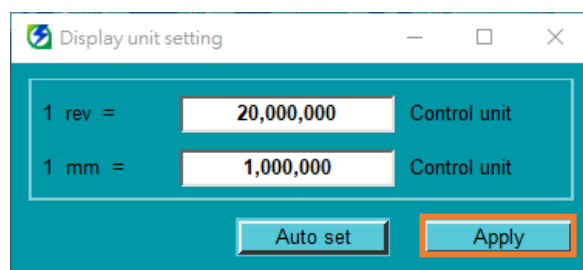

Figure 10.2.3.2.5

10.2.3.3 Where to apply

The parameter which applies display unit will be modified to the corresponding unit name (as Table 10.2.2.2 shows). The color of the string is displayed in **orange**.



Test Run: Pt533 does not apply display unit “ctrl unit”.

Example

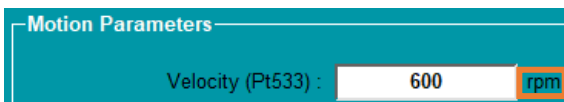

Figure 10.2.4.1

Test Run: Pt533 applies display unit “rev”.

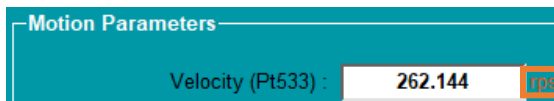

Figure 10.2.4.2

The interfaces which apply display unit are as below:

Test Run, Homing Operation, Error map setup, Gantry control system and Performance monitor.



Figure 10.2.4.3

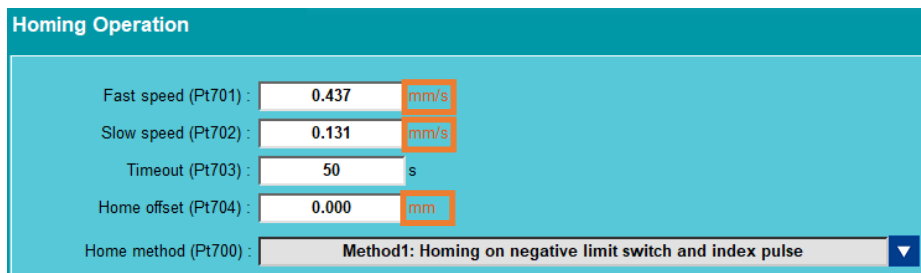

Figure 10.2.4.4

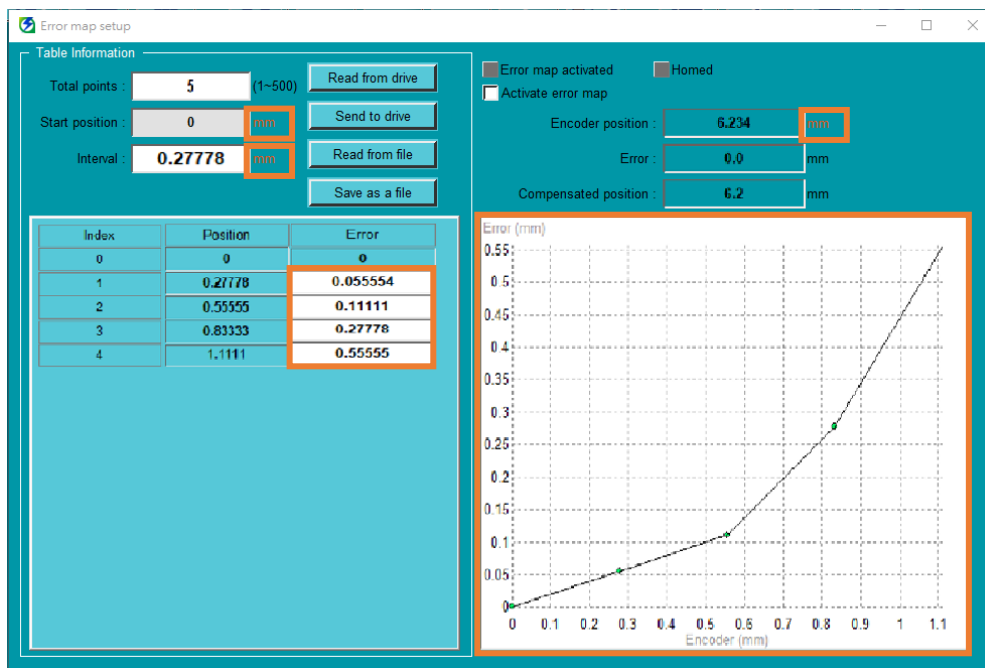

Figure 10.2.4.5

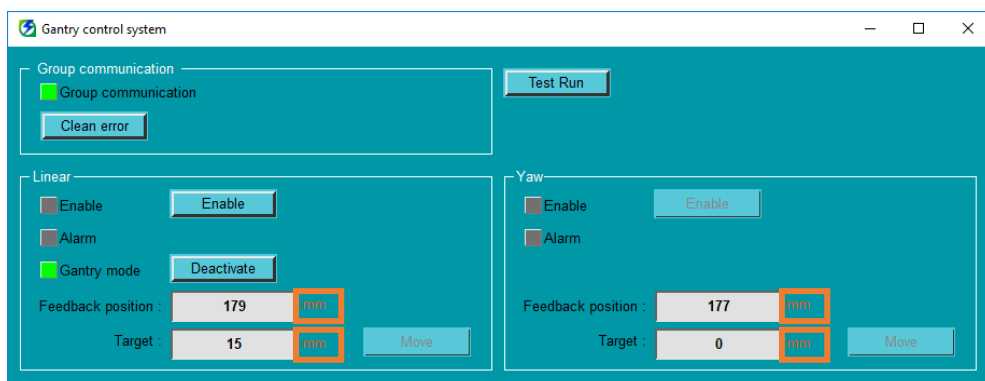

Figure 10.2.4.6

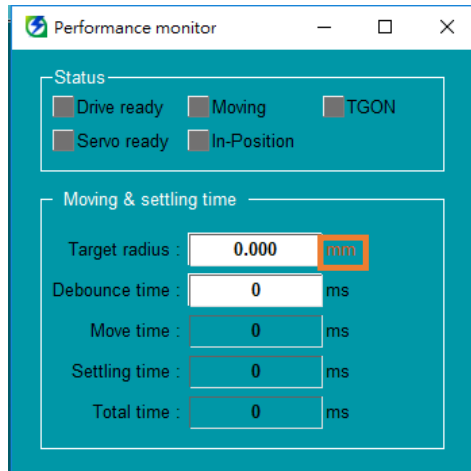

Figure 10.2.4.7

10.3 Language switching

10.3.1 Brief introduction

Users can switch Thunder display language. The current version supports English, Traditional Chinese and Simplified Chinese.

10.3.2 Language switching setting

Follow the procedure below to set display language.

1. Select **Settings** in the menu bar and click **Language**.

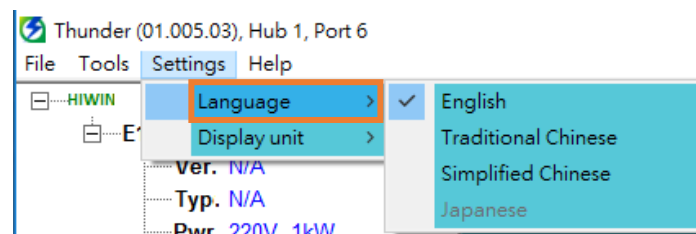

Figure 10.3.2.1

2. Select the language to be displayed.

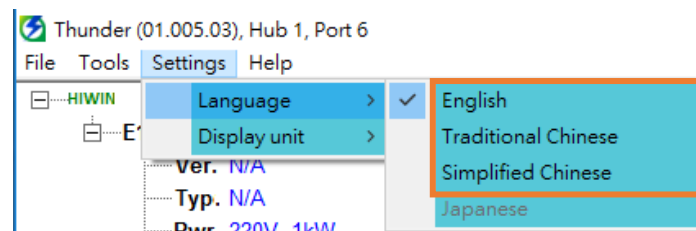

Figure 10.3.2.2



Important

Some windows will automatically close during language switching. Therefore, complete the operation in the window first.

10.4 Help

10.4.1 Brief introduction

Users can quickly open the folder where the relative manuals of E1 series servo drive are placed and check Thunder version number.

10.4.2 Help setting

Follow the procedure below to open the folder where the relative manuals of E1 series servo drive are placed.

1. Select **Help** in the menu bar and click **User guide**.

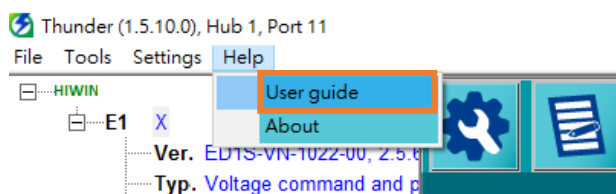

Figure 10.4.2.1

2. Read the corresponding manual based on requirement.

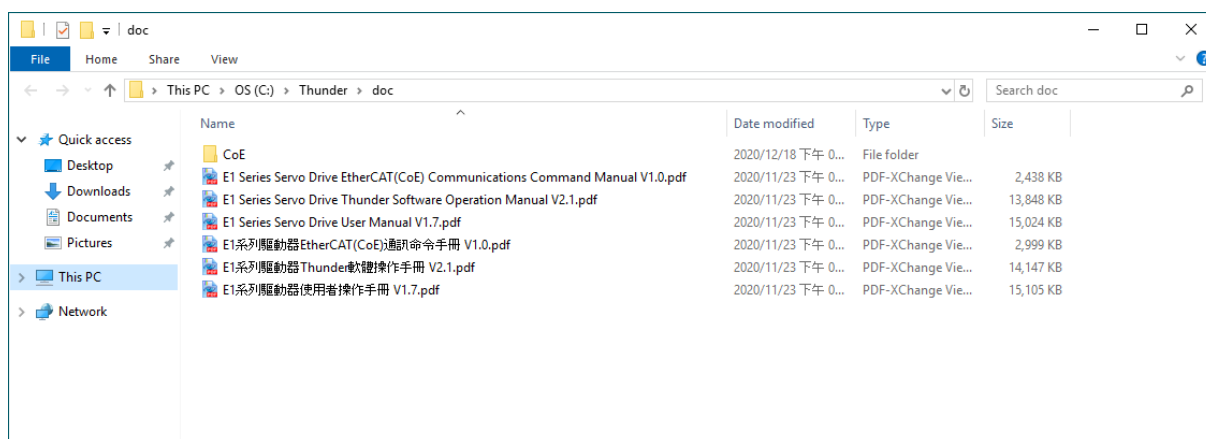

Figure 10.4.2.2

Follow the procedure below to check Thunder version number.

1. Select **Help** in the menu bar and click **About**.

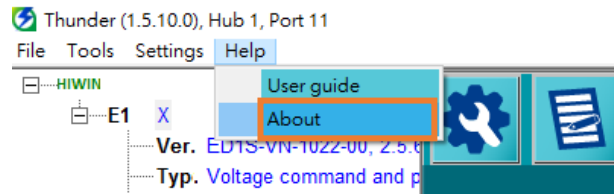

Figure 10.4.2.3

2. Check Thunder version number, and click **OK**.

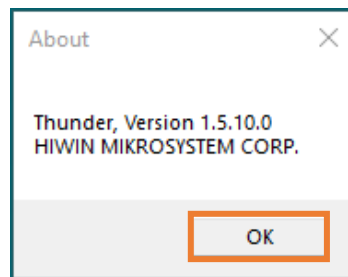

Figure 10.4.2.4

(This page is intentionally left blank.)

11. Appendix

11.	Appendix.....	11-1
11.1	Examples for servo drive configuration	11-2
11.1.1	AC servo motor (EM1 series).....	11-3
11.1.2	DM direct drive motor (RM series).....	11-6
11.1.3	Linear motor	11-10

11.1 Examples for servo drive configuration

This section takes three different kinds of motors for example:

- ◆ HIWIN self-made AC servo motor (EM1 series)
- ◆ HIWIN self-made DM direct drive motor (RM series)
- ◆ Linear motor

Refer to chapter 4 for more detailed descriptions of servo drive configuration.

AC servo motor (EM1 series)

With EM1 series motor, Thunder will automatically fill in motor parameters. This section demonstrates the operation of servo drive configuration with AC servo motor (EM1 series).

DM direct drive motor (RM series)

With RM series motor, Thunder will automatically fill in motor parameters after users complete pre-configuration function setting. This section demonstrates the operation of servo drive configuration with DM direct drive motor (RM series).

Linear motor

With linear motor, users must select motor parameters. This section demonstrates the operation of servo drive configuration with linear motor.

11.1.1 AC servo motor (EM1 series)

Connect AC servo motor (EM1 series) to servo drive’s motor power connector (CN2) and encoder connector (CN7). Refer to section 5.4 in “E1 Series Servo Drive User Manual” for the wiring of servo motor.

With EM1 series motor, Thunder will automatically fill in motor parameters. This section takes AC servo motor EM1-C-M-40-2-B-F-0-A as an example to demonstrate the basic settings of servo drive. Follow the procedure below to complete servo drive configuration.

1. Select **Tools** in the menu bar and click **Set to factory default**.

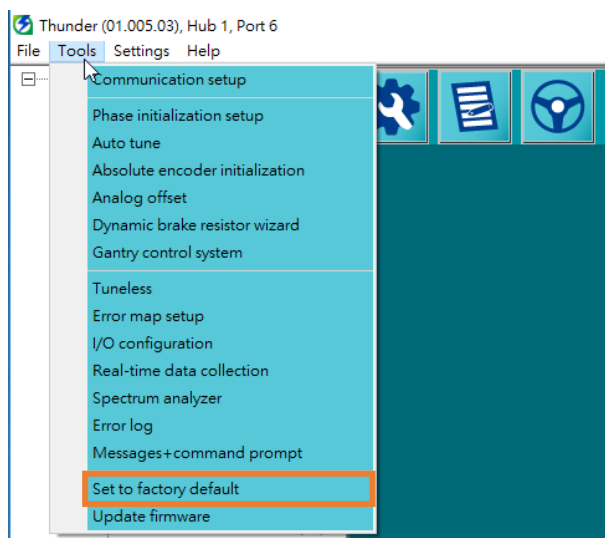

Figure 11.1.1.1

2. Click **Ok**.

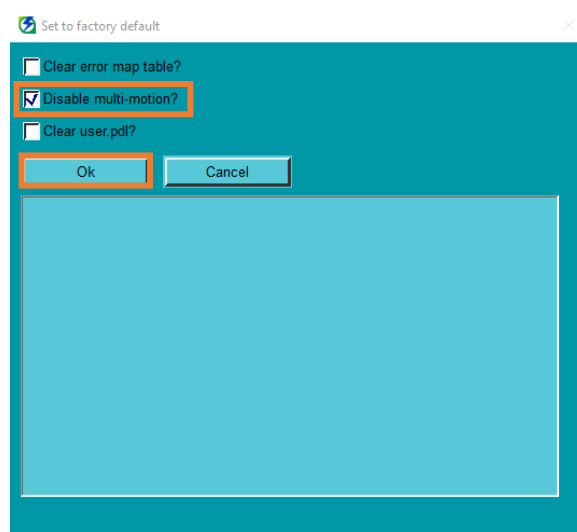

Figure 11.1.1.2

- Click "Open Configuration Wizard" icon in the toolbar to open "Configuration Wizard" window.

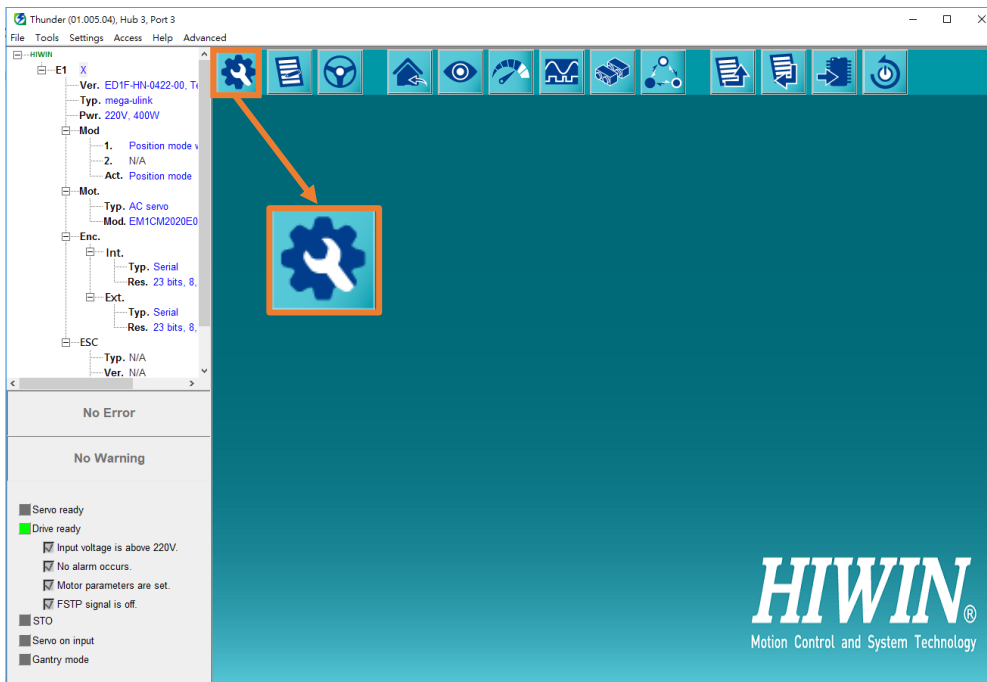

Figure 11.1.1.3

- Enter **Motor Setup** page to view motor parameters automatically filled in. Refer to section 4.3.3 for the detailed descriptions.

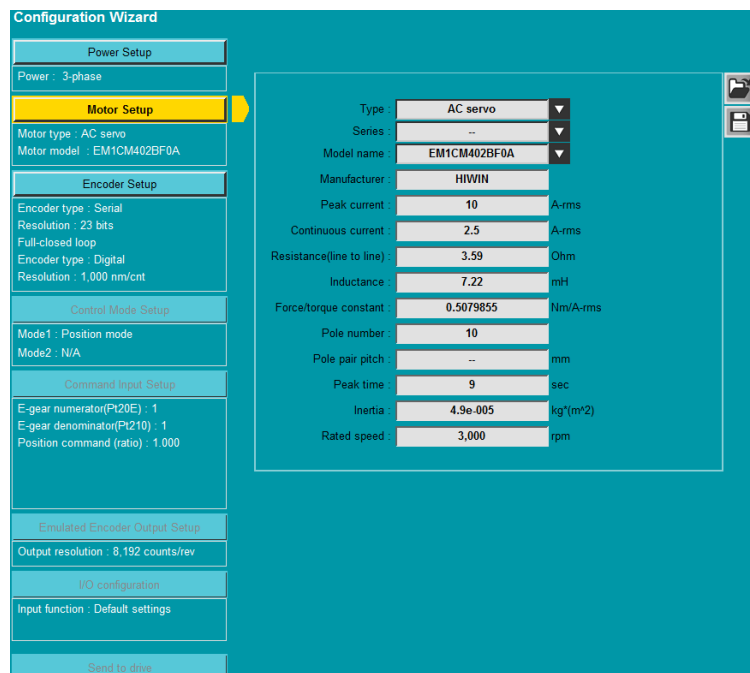

Figure 11.1.1.4

- Enter **Encoder Setup** page to view encoder parameters automatically filled in. Refer to section 4.3.4 for the detailed descriptions.

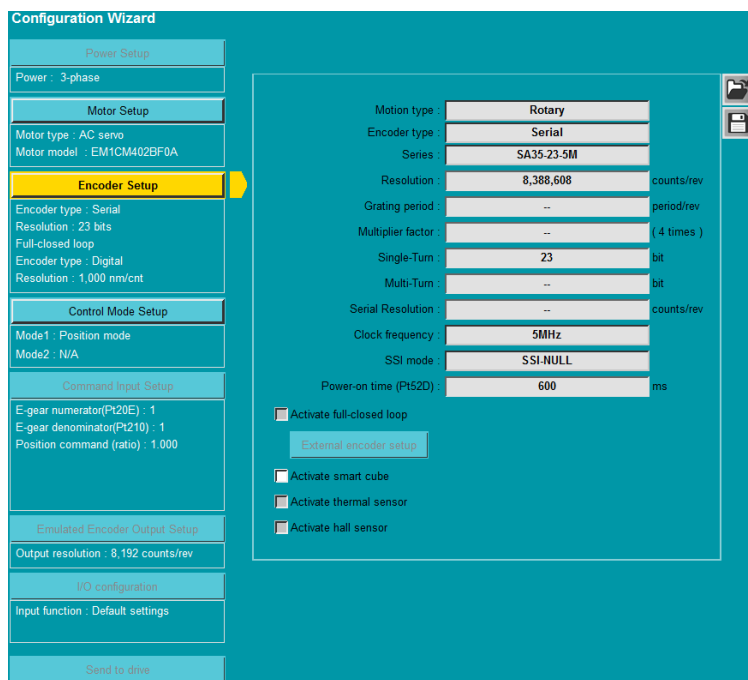

Figure 11.1.1.5

- Refer to section 4.3.4 to 4.3.9 to complete servo drive configuration.

11.1.2 DM direct drive motor (RM series)

Connect DM direct drive motor (RM series) to servo drive’s motor power connector (CN2) and encoder connector (CN7). Refer to section 5.4 in “E1 Series Servo Drive User Manual” for the wiring of servo motor.

With RM series motor, Thunder will automatically fill in motor parameters after users complete pre-configuration function setting. This section takes DM direct drive motor DMN71-B0SN00 as an example to demonstrate the basic settings of servo drive. Follow the procedure below to complete servo drive configuration.

1. Select **Tools** in the menu bar and click **Set to factory default**.

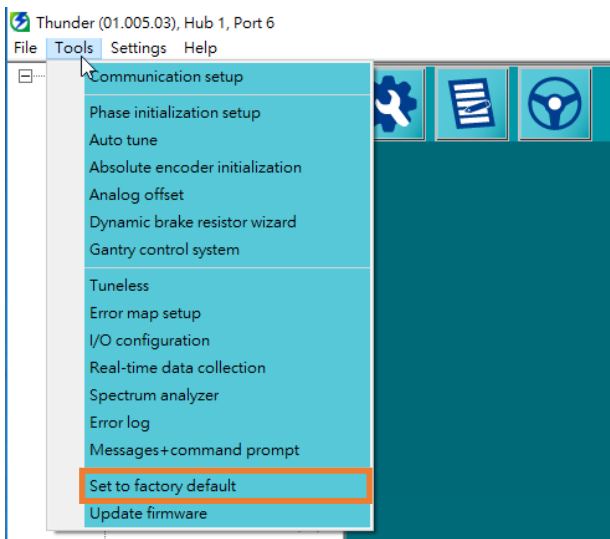

Figure 11.1.2.1

2. Click **Ok**.

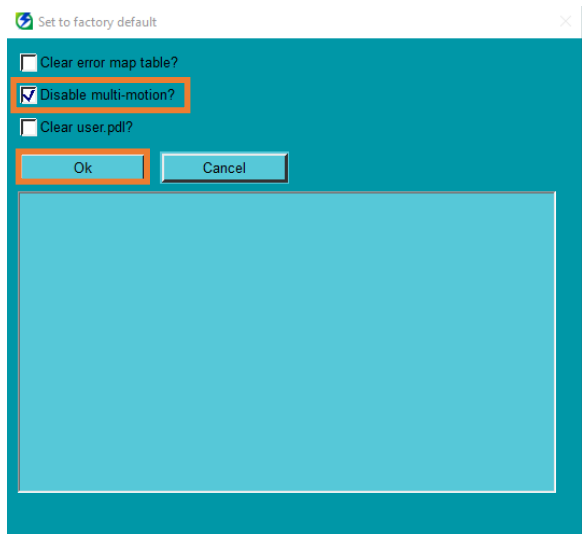

Figure 11.1.2.2

- After servo drive is power cycled, “Pre-Configuration” window will show up. Select **Torque / direct drive motor** for motor type.

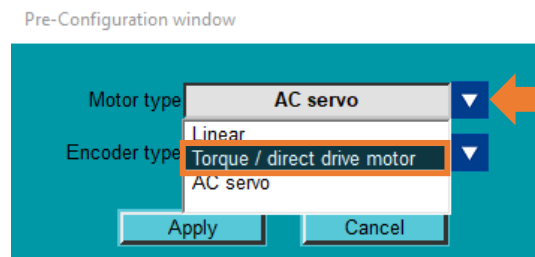

Figure 11.1.2.3

- Select **Serial** for encoder type.

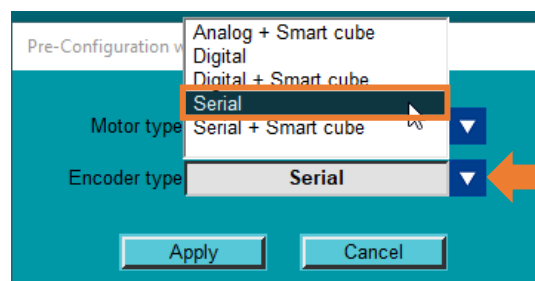

Figure 11.1.2.4

- After the selection, click **Apply** to complete pre-configuration function setting. At this time, servo drive will be power cycled. After that, go to **Configuration Wizard** to continue setting servo drive.

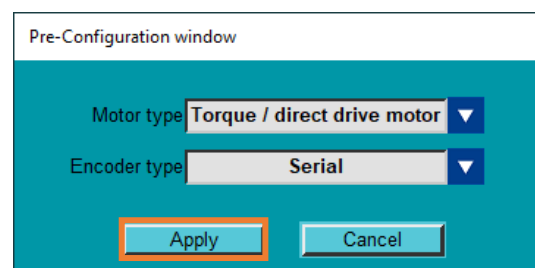

Figure 11.1.2.5

- Click “Open Configuration Wizard” icon in the toolbar to open “Configuration Wizard” window.

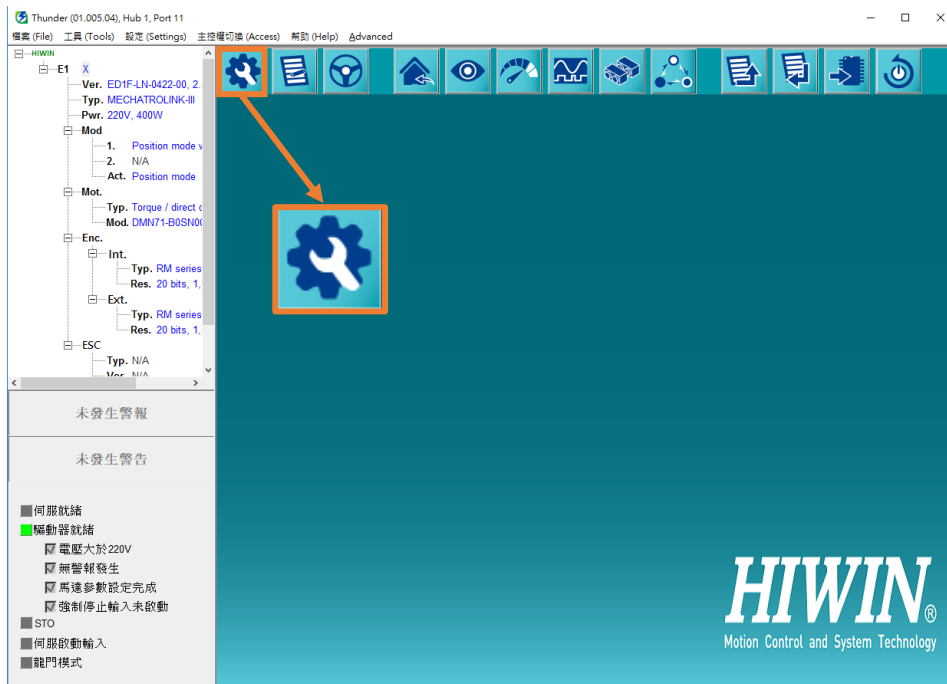

Figure 11.1.2.6

7. Enter **Motor Setup** page to view motor parameters automatically filled in. Refer to section 4.3.3 for the detailed descriptions.

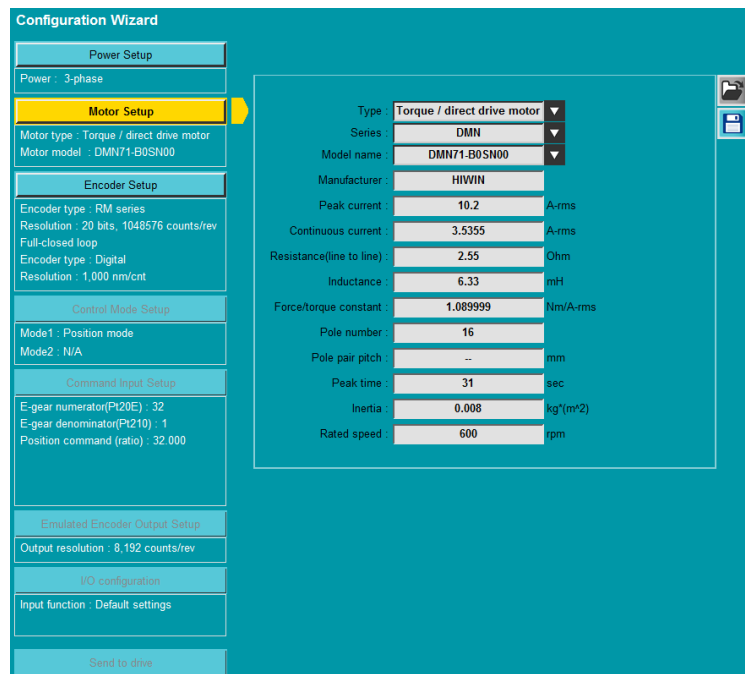

Figure 11.1.2.7

8. Enter **Encoder Setup** page to view encoder parameters automatically filled in. Refer to section 4.3.4 for the detailed descriptions.

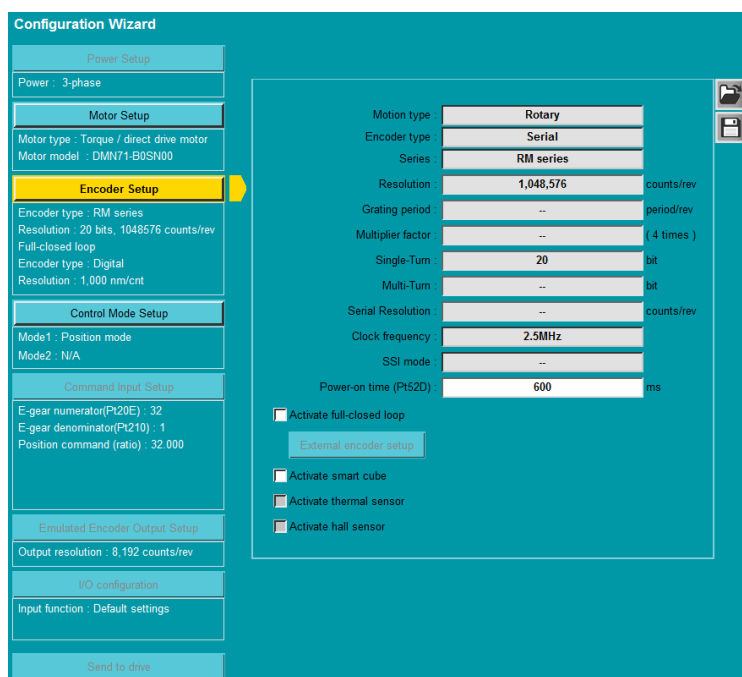

Figure 11.1.2.8

9. Refer to section 4.3.4 to 4.3.9 to complete servo drive configuration.

11.1.3 Linear motor

Connect linear motor to servo drive’s motor power connector (CN2) and encoder connector (CN7). Refer to section 5.4 in “E1 Series Servo Drive User Manual” for the wiring of servo motor.

With linear motor, users must select motor parameters. This section takes linear motor LMSA12 as an example to demonstrate the basic settings of servo drive. Follow the procedure below to complete servo drive configuration.

1. Select **Tools** in the menu bar and click **Set to factory default**.

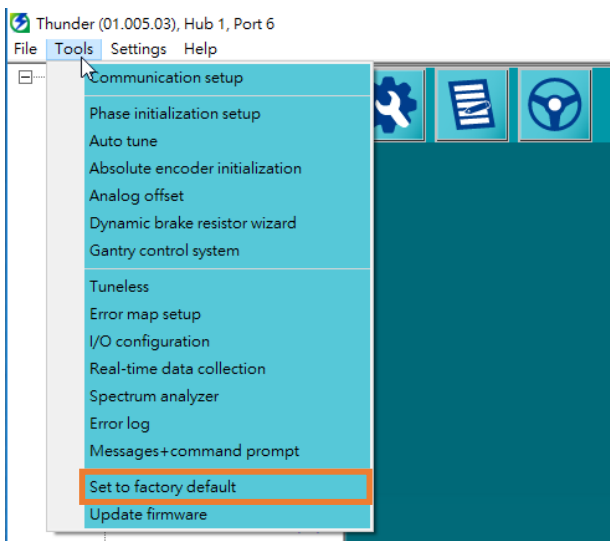

Figure 11.1.3.1

2. Click **Ok**.

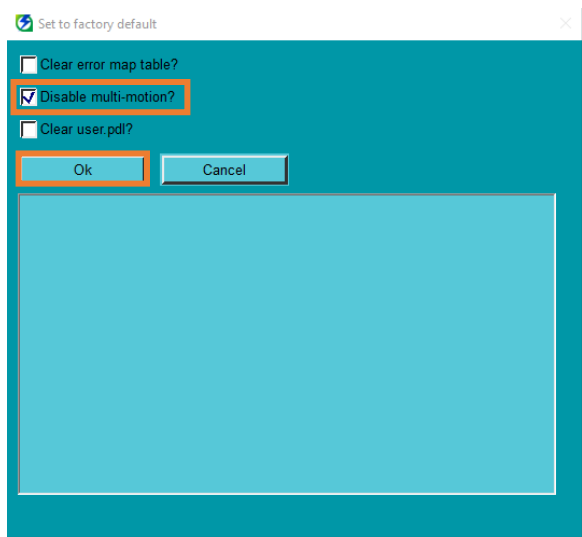

Figure 11.1.3.2

- After servo drive is power cycled, “Pre-Configuration” window will show up. Select **Linear** for motor type.

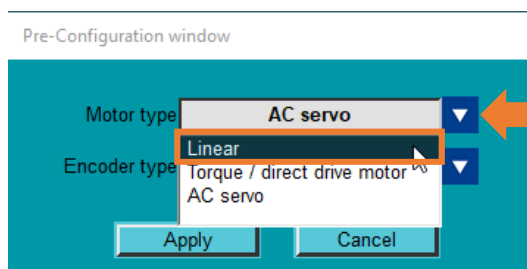

Figure 11.1.3.3

- Select encoder format. Here takes **Digital** as an example.

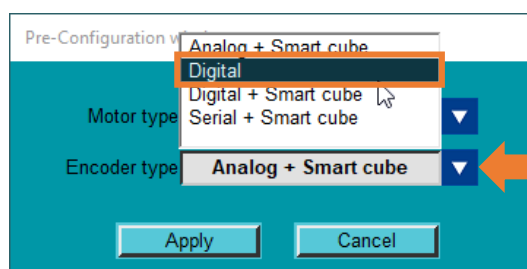

Figure 11.1.3.4

- After the selection, click **Apply** to complete pre-configuration function setting. At this time, servo drive will be power cycled. After that, go to **Configuration Wizard** to continue setting servo drive.

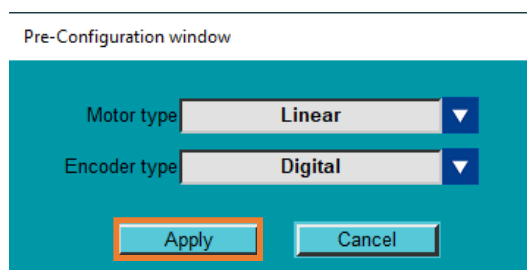

Figure 11.1.3.5

- Click “Open Configuration Wizard” icon in the toolbar to open “Configuration Wizard” window.

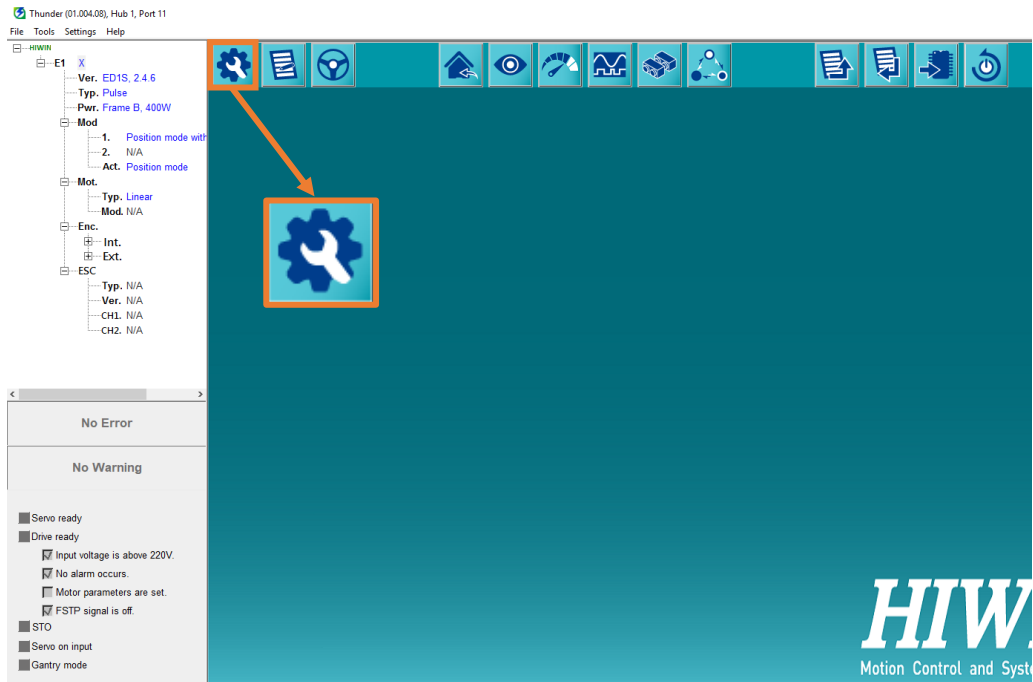

Figure 11.1.3.6

7. Enter **Motor Setup** page. Select **LMSA** in “Series” column.

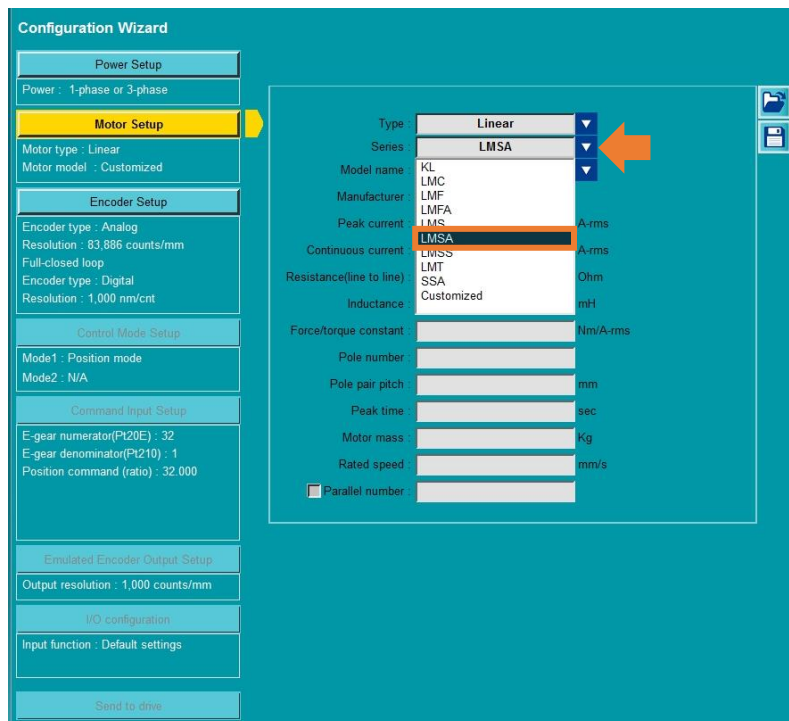

Figure 11.1.3.7

- Select **LMSA12** in “Model name” column. Motor parameters will be automatically filled in. Refer to section 4.3.3 for the detailed descriptions.

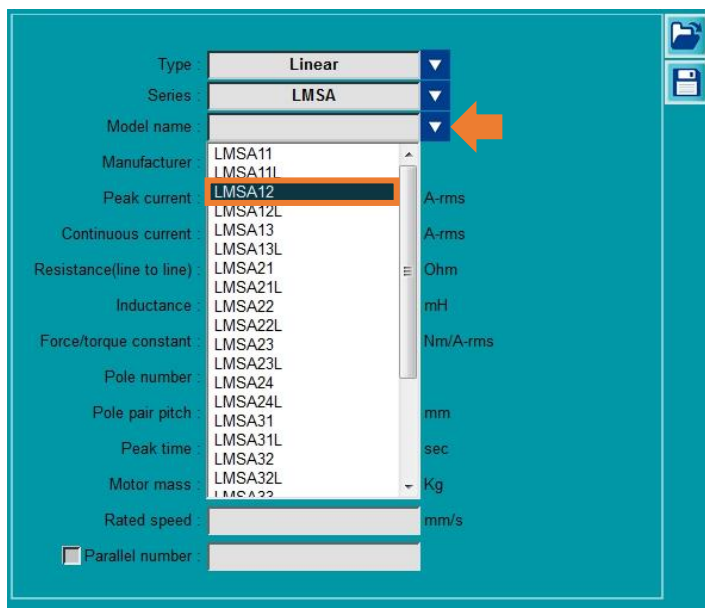

Figure 11.1.3.8



Information

If the motors are connected in parallel, check **Parallel number** and key in the total number of motors in the yellow box.

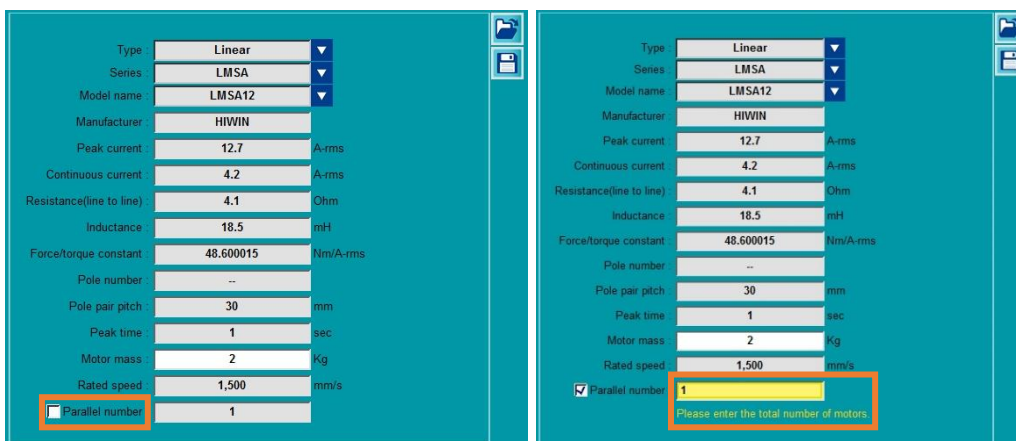

Figure 11.1.3.9

- Enter **Encoder Setup** page to set encoder parameters. Refer to section 4.3.4 for the detailed descriptions.

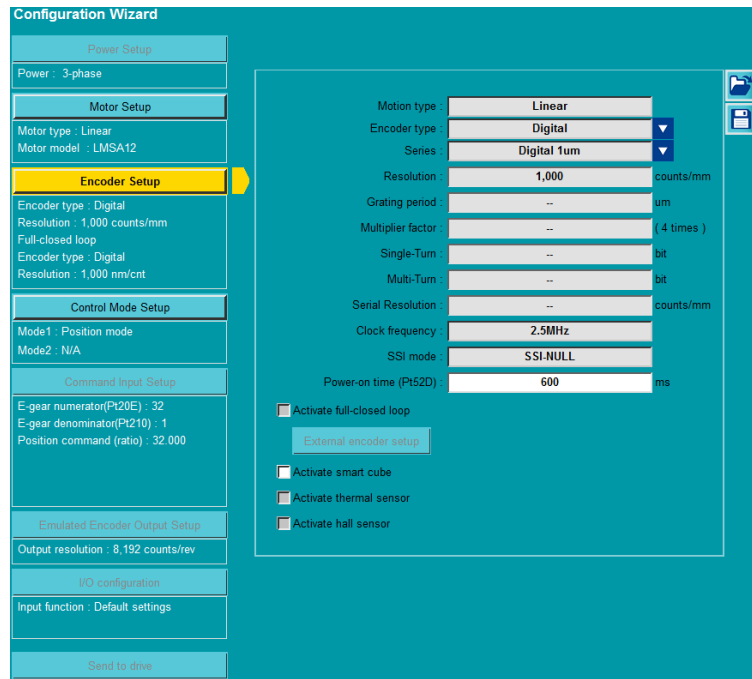

Figure 11.1.3.10

10. Refer to section 4.3.4 to 4.3.9 to complete servo drive configuration.